



**JBM<sup>®</sup>**  
**SUA FERRAMENTA**

## CAIXAS DE FERRAMENTAS

5

MALAS DE FERRAMENTAS  
MALAS DE ALUMÍNIO  
CHAVES AUTOMOTIVAS - AUTOCLÉ  
CONJUNTOS DE CHAVES CAIXA  
CONJUNTO DE PONTAS - BITS  
MALAS DE BITS  
ADAPTADORES  
ESTOJOS COM MINI ROQUETES  
JOGOS DE CHAVE DE CAIXA  
JOGOS DE PONTAS - BITS  
FERRAMENTAS ISOLADAS



## FERRAMENTAS MANUAIS

33

CHAVES  
FERRAMENTAS EM POLEGADAS  
CHAVES DE FENDA  
MEDIÇÃO  
CADEADOS  
MARTELOS  
SERRAS  
CINZEL  
REBITADORES  
CATRACAS - ROQUETES  
BARRAS DE EXTENSÃO  
FERRAMENTAS DE INSPEÇÃO  
CORTADOR DE TUBOS  
DESCAPADOR DE FIO  
ALICATES  
CHAVES DE GANCHO /  
QUEBRAS PORCAS  
/ CHAVE INGLESA  
CHAVES STILLSON / SARGENTOS



## MOBILIÁRIO DE OFICINA

65

CARROS DE FERRAMENTAS  
MÓDULOS DE FERRAMENTA  
ACESSÓRIOS  
/ PEÇAS PARA AUTOMÓVEIS  
ARMÁRIOS  
ACESSÓRIOS PARA MESAS  
MESAS DE TRABALHO  
CAIXAS DE FERRAMENTAS  
BANCOS / ESTRADOS  
BIGORNAS / PARAFUSOS DE  
BANCO



## FERRAMENTA A BATERIAS MOTOR BRUSHLESS

87

CHAVES DE IMPACTO  
CATRACA / CHAVE DE FENDA  
BERBEQUIM DE IMPACTO  
POLIDOR  
SERRAS  
MULTIFERRAMENTA OSCILANTE  
PISTOLAS  
ASPIRADOR/COMPRESSOR  
ILUMINAÇÃO LED  
JARDINAGEM  
ARMAZENAMENTO  
BATERIAS / CARREGADORES  
ACESSÓRIOS /  
CONSUMÍVEIS



## ILUMINAÇÃO

113

GAMBIARRAS  
GAMBIARRA DE LUZ FRONTAL  
LUPAS LED / LANTERNAS  
FOCO DE LED/ALINHADORES DE FARÓIS/  
TOMADAS E TRANSFORMADORES DE ISQUEIRO  
BARRAS DE LED  
LÂMPADA DE LED INDUSTRIAL  
LUZ DE EMERGÊNCIA - ROTATIVOS  
AVISOS ACÚSTICOS  
LUZES DE TRABALHO  
PARA REBOQUE  
LÂMPADAS DE TURISMO



## FERRAMENTAS PNEUMÁTICAS

131

PISTOLAS DE IMPACTO  
PARA CAMINHÕES  
BERNEQUINS/ROQUETES  
MÁQUINAS DE CORTE /  
KIT DE POLIMENTO  
REBARBADORAS  
DESTANOLADOR PNEUMÁTICO  
/ RODA VÁLVULAS  
LIXADEIRA ORBITAL / POLIDORES  
MARTELOS PNEUMÁTICOS  
DISCOS DE CORTE / DISPLAYS  
PISTOLA DE INFLAR / DPF  
FILTROS DE AR / ÓLEOS LUBRIFICANTES  
PISTOLAS DIVERSAS  
ENROLADOR DE MANGUEIRA DE AR  
MANGUEIRAS DE AR / CONECTORES  
ADAPTADORES / ENGATES



## FERRAMENTAS DE IMPACTO

149

CONJUNTOS DE CHAVES DE CAIXA DE IMPACTO  
BARRAS DE EXTENSÃO  
/ ARTICULADORES DE IMPACTO  
CONJUNTOS DE PONTAS  
ADAPTADORES DE IMPACTO  
/ CHAVES DE CAIXA DE  
IMPACTO DE 3/4" E 1"  
FERRAMENTAS DE IMPACTO VEÍCULOS PESADOS



## CARROÇARIA

159

PARA CARROÇARIA  
PARA FARÓIS  
CAPACETES DE SOLDAGEM  
/ CONJUNTOS DE ALAVANCAS  
JOGO PARA ABRIR CARROS  
/ SUBSTITUIÇÃO DE PARA-BRISAS  
MORDAÇAS  
PISTOLAS DE SILICONE / VENTOSAS  
FITAS DE FIXAÇÃO / CARROS E  
ARMAZENAMENTO  
CAVALETES / SUPORTES  
MANUTENÇÃO DE VEÍCULOS /  
EXPOSITORES  
ESTRADOS  
PLATAFORMAS DE ALUMÍNIO



## TRAVÕES

173

REPOSICIONADORES PARA PISTÕES DE FREIO  
REPARAÇÃO / MANUTENÇÃO  
/ SANGRADOS DE FREIO



## UTILLAJE

177

SISTEMA DE LUBRIFICAÇÃO  
SISTEMA DE INJEÇÃO  
REPARADOR DE ROSCAS - CARTER  
MEDIDOR DE COMPRESSÃO  
AQUECEDORES  
EXTRATORES  
DINAMOMÉTRICAS  
MULTIPLICADORES DE FORÇA  
/ EMBREAMEM  
SISTEMA AACC  
SISTEMA DE REFRIGERAÇÃO  
CABECOTE / VÁLVULAS  
COMPRESSORES DE MOLA  
VARIADOS  
ORGANIZADORES / BANDEJAS  
CORTADORES DE CORRENTES  
/ ESCOVAS





## KITS DE BLOQUEIO

217

BMW  
MERCEDES  
VAG  
RENAULT / NISSAN  
FORD / MAZDA  
JAGUAR / LAND ROVER  
OPEL / VAUXHALL  
CITROËN / PEUGEOT  
VÁRIOS  
GABINETE COM FERRAMENTAS  
DE AJUSTE DE SINCRONIZAÇÃO



## ACESSÓRIOS LUBRIFICANTES

247

MACACOS HIDRÁULICOS  
MACACO DE GARRAFA  
PREGUIÇAS  
TRANSPORTADOR DE RODAS/  
PNEU  
PRENSAS  
GRUAS  
SUPORTES PARA MOTORES  
PARA MOTAS  
TRASPALET



## FERRAMENTAS HIDRÁULICAS

259

MACACOS HIDRÁULICOS  
MACACO DE GARRAFA  
PREGUIÇAS  
TRANSPORTADOR DE RODAS/PNEU  
PRENSAS  
GRUAS  
SUPORTES PARA MOTORES  
PARA MOTAS  
TRASPALET



## FERRAMENTAS ELÉTRICAS

271

ARRANCADORES DE BATERIAS  
CARREGADORES  
/ COMPROVADORES DE BATERIA  
MEDIDORES DE CORRENTE  
TERMÔMETROS  
ENDOSCÓPIOS  
SOLDADORES  
AMOLADORA DE MESA  
LIMPADORES DE PEÇAS  
ASPIRADORES  
AQUECEDORES  
/ ROBÔ CORTADOR DE RELVA  
LAVADORA DE ALTA PRESSÃO  
EXTENSÕES ELÉTRICAS  
VENTILADORES



## ENERGIAS RENOVÁVEIS E MOBILIDADE DE AMANHÃ

285

ESTAÇÃO DE CARGA PORTÁTIL  
PAINEL SOLAR  
CARRO ELÉTRICO / CABOS  
ACESSÓRIOS  
FERRAMENTAS ISOLADAS



## ACESSÓRIOS

291

CARRETEIS  
ESCADAS  
CARROS  
ORGANIZADORES  
PARA CARRO  
KITS DE EMERGÊNCIA /  
KITS DE PRIMEIROS SOCORROS  
SENSORES DE ESTACIONAMENTO  
TAPETES  
ESCOVAS LIMPA-VIDROS  
CONTRAPESOS  
VÁLVULAS TPMS  
PARA PNEUS  
FOLE DE TURISMO UNIVERSAL /  
FERRAMENTA PNEUMÁTICA PARA  
MONTAGEM DE FOLE



## SEGURANÇA E EPI

315

LUVAS / EPIS  
KIT DE PRIMEIROS SOCORROS  
MÁSCARAS / DISPENSADORES  
CÂMERAS TÉRMICAS /  
TERMÔMETROS  
/ DETERGENTES DE SUPERFÍCIE /  
LIMPADORES  
DISTÂNCIA DE SEGURANÇA  
DESINFECÇÃO DE ESPAÇOS  
/ MEDIDOR DE OZÔNIO



## CONSUMÍVEIS

323

PASSA-CABOS / CAVILHAS  
CHAVES / PARAFUSOS E PORCAS  
REBITES  
ARRUELA  
VÁLVULAS  
O-RINGS / TUBOS DE REDUÇÃO  
TÉRMICA  
CONECTORES DE MANGUEIRAS /  
LUBRIFICADORES  
BRAÇADEIRAS / MOLAS / FUSÍVEIS  
TERMINAIS  
CLIPES DE PLÁSTICO



## ROUPA

345

COLETE  
JAQUETA



## PROMOCIONAIS

347

DISPOSITIVOS  
ELETRÔNICOS JBM  
PROMOTIONALS  
EXPOSITORES E  
ACESSÓRIOS  
EMBALAGEM





**JBM é a sua marca de ferramentas profissionais**  
Empresa líder, especializada na indústria e no setor automotivo

**+5.000** PRODUTOS  
DISPONÍVEIS

**+20.000** EUROPALETES  
EM ESTOQUE

**+450** NOVOS PRODUTOS  
POR ANO

**+55** EXPORTAMOS PARA  
MAIS DE 55 PAÍSES

**SERVIÇO  
DE QUALIDADE  
APOIADO POR MAIS  
DE 11.000 CLIENTES**

▶ **MAIS DE 30 ANOS DE EXPERIÊNCIA NO SETOR**

Na JBM somos especialistas na distribuição de ferramentas e equipamentos automotivos, oferecendo um atendimento próximo e de qualidade aos nossos mais de 11.000 clientes espalhados por mais de 55 países.

▶ **ESPECIALISTAS EM DISTRIBUIÇÃO E LOGÍSTICA**

A JBM dispõe de uma rede logística em constante melhoria, que permite uma distribuição rápida e eficiente não só na Península Ibérica mas também a todos os clientes internacionais.

▶ **AMPLA GAMA DE PRODUTOS**

Oferecemos uma gama completa de mais de 4.000 itens como caixas de ferramentas, estojos, mobiliário para oficina, todos os tipos de ferramentas manuais, ferramentas de oficina, iluminação, estojos de consumíveis e muito mais...



**ENTREGA ENTRE 24-48H NA  
PENÍNSULA IBÉRICA E FRANÇA**



**SEDE EM ESPANHA E ARMAZÉM  
DE MAIS DE 6.000M<sup>2</sup>**







## **CAIXAS DE FERRAMENTAS**

- 7 MALAS DE FERRAMENTAS
- 20 MALAS DE ALUMÍNIO
- 23 CHAVES AUTOMOTIVAS - AUTOCLÉ
- 24 CONJUNTOS DE CHAVES CAIXA
- 25 CONJUNTO DE PONTAS - BITS
- 27 MALAS DE BITS
- 28 ADAPTADORES
- 29 ESTOJOS COM MINI ROQUETES
- 29 JOGOS DE CHAVE DE CAIXA
- 29 JOGOS DE PONTAS - BITS
- 31 FERRAMENTAS ISOLADAS



# ACABAMENTOS DE QUALIDADE



DIVISÍVEL EM DOIS PARA UMA MELHOR ORGANIZAÇÃO



FECHO DE METAL MELHORADOS



ALÇA DE BORRACHA PARA MAIOR COMODIDADE NO TRANSPORTE





# CAIXA DE FERRAMENTAS DE 216 PEÇAS COM CHAVES HEXAGONAIS

**54034** 178,00€

11.45	-	2	48
Kg	SUB	11	

ZINCADO

**54045** 179,00€

11.45	-	2	48
Kg	SUB	11	

CROMADO

ACO  
S2

CrV

216  
PCS

**54034**



REPOSIÇÕES  
DISPONÍVEIS









**54045**





















REPOSIÇÕES  
DISPONÍVEIS



## CONTÉM

	<b>1/2"</b> x14	13, 14, 15, 16, 17, 18, 19, 20, 21, 22, 24, 27, 30, 32mm
	<b>3/8"</b> x10	10, 11, 12, 13, 14, 15, 16, 17, 18, 19mm
	<b>1/4"</b> x13	4, 4.5, 5, 5.5, 6, 7, 8, 9, 10, 11, 12, 13, 14mm
	<b>1/2"</b> x5	16, 17, 18, 19, 22mm
	<b>3/8"</b> x6	10, 11, 12, 13, 14, 15mm
	<b>1/4"</b> x7	4, 5, 6, 7, 8, 9, 10mm
	<b>1/2"</b> x3	E20, E22, E24
	<b>3/8"</b> x6	E10, E11, E12, E14, E16, E18
	<b>1/4"</b> x5	E4, E5, E6, E7, E8
	<b>T2</b> x3	1/2" - 3/8" - 1/4"
	<b>1/2"</b> x2	125, 250mm
	<b>3/8"</b> x1	125mm
	<b>1/4"</b> x2	50, 100mm
	x3	1/2" - 3/8" - 1/4"
	<b>1/2"</b> x1	adaptador 3/8" H x 1/2" M

	<b>1/2"</b> x1	8mm
	<b>3/8"</b> x1	8mm
	<b>1/4"</b> x1	6mm
	<b>1/2"</b> x2	16, 21mm
	<b>3/8"</b> x1	18mm
	<b>1/2"</b> x12	8, 9, 10, 11, 12, 13, 14, 15, 16, 17, 18, 19mm
	<b>1/2"</b> x7	1.27, 1.5, 2, 2.5, 3, 4, 5mm
	<b>1/4"</b> x1	
	<b>1/4"</b> x1	
	<b>1/4"</b> x1	
	<b>1/2"</b> x1	T70
	<b>1/2"</b> x1	14mm
	x3	PH0, PH1, PH2
	x3	PZ0, PZ1, PZ2
	x4	3, 4, 5, 6mm
	x4	SL4, SL5.5, SL6.5, SL7
	x8	T8, T9, T10, T15, T20, T25, T27, T30
	x8	T8, T9, T10, T15, T20, T25, T27, T30

	<b>8mm</b> x4	7, 8, 10, 12mm
	<b>6mm</b> x6	2, 2.5, 3, 4, 5, 6mm
	<b>8mm</b> x3	SL8, SL10, SL12
	<b>8mm</b> x3	PH2, PH3, PH4
	<b>8mm</b> x3	PZ2, PZ3, PZ4
	<b>8mm</b> x5	T40, T45, T50, T55, T60
	<b>6mm</b> x3	T5, T6, T7
	<b>8mm</b> x5	T40, T45, T50, T55, T60
	<b>6mm</b> x1	T7
	<b>8mm</b> x4	M10, M11, M12, M13
	<b>6mm</b> x5	M5, M6, M7, M8, M9
	<b>8mm</b> x2	M10, M12
	<b>6mm</b> x3	M5, M6, M8
	<b>8mm</b> x1	TS50
	<b>6mm</b> x8	TS10, TS15, TS20, TS25, TS27, TS30, TS40, TS45
	x4	0, 1, 2, 3mm
	x3	6, 8, 10mm
	<b>6mm</b> x4	4, 6, 8, 10mm
	x3	1, 2, 3mm
	x4	1, 2, 3, 4mm
	<b>6mm</b> x1	1/4"

# CAIXA DE FERRAMENTAS DE 216 PEÇAS 12 FACES (XZN) - ZINCADAS

54250

188,00€

11,50	-	2	48
Kg	SUB	11	

AÇO S2

CrV

216 PCS



REPOSIÇÕES DISPONÍVEIS



## CONTÉM

	<b>1/2"</b>	x14	13, 14, 15, 16, 17, 18, 19, 20, 21, 22, 24, 27, 30, 32mm
	<b>3/8"</b>	x10	10, 11, 12, 13, 14, 15, 16, 17, 18, 19mm
	<b>1/4"</b>	x13	4, 4.5, 5, 5.5, 6, 7, 8, 9, 10, 11, 12, 13, 14mm
	<b>1/2"</b>	x5	16, 17, 18, 19, 22mm
	<b>3/8"</b>	x6	10, 11, 12, 13, 14, 15mm
	<b>1/4"</b>	x7	4, 5, 6, 7, 8, 9, 10mm
	<b>1/2"</b>	x3	E20, E22, E24
	<b>3/8"</b>	x6	E10, E11, E12, E14, E16, E18
	<b>1/4"</b>	x5	E4, E5, E6, E7, E8
	<b>72</b>	x3	1/2" - 3/8" - 1/4"
	<b>1/2"</b>	x2	125, 250mm
	<b>3/8"</b>	x1	125mm
	<b>1/4"</b>	x2	50, 100mm
		x3	adaptor for 3/8" H x 1/2" M
	<b>1/2"</b>	x1	

	<b>1/2"</b>	x1	8mm
	<b>3/8"</b>	x1	8mm
	<b>1/4"</b>	x1	6mm
	<b>1/2"</b>	x2	16, 21mm
	<b>3/8"</b>	x1	18mm
	<b>1/2"</b>	x12	16, 10, 11, 12, 13, 14, 15, 16, 17, 18, 19mm
	<b>1/2"</b>	x7	1.27, 1.5, 2, 2.5, 3, 4, 5mm
	<b>1/4"</b>	x1	
	<b>1/4"</b>	x1	
	<b>1/4"</b>	x1	
	<b>1/2"</b>	x1	T70
	<b>1/2"</b>	x1	14mm
		x3	PH0, PH1, PH2
		x3	PZ0, PZ1, PZ2
	<b>1/4"</b>	x4	3, 4, 5, 6mm
		x4	SL4, SL5.5, SL6.5, SL7
		x8	T8, T9, T10, T15, T20, T25, T27, T30
		x8	T8, T9, T10, T15, T20, T25, T27, T30

	<b>8mm</b>	x4	7, 8, 10, 12mm
	<b>6mm</b>	x6	2, 2.5, 3, 4, 5, 6mm
	<b>8mm</b>	x3	SL8, SL10, SL12
	<b>8mm</b>	x3	PH2, PH3, PH4
	<b>8mm</b>	x3	PZ2, PZ3, PZ4
	<b>8mm</b>	x5	T40, T45, T50, T55, T60
	<b>6mm</b>	x3	T5, T6, T7
	<b>8mm</b>	x5	T40, T45, T50, T55, T60
	<b>6mm</b>	x1	T7
	<b>8mm</b>	x4	M10, M11, M12, M13
	<b>6mm</b>	x5	M5, M6, M7, M8, M9
	<b>8mm</b>	x2	M10, M12
	<b>6mm</b>	x3	M5, M6, M8
	<b>8mm</b>	x1	TS50
	<b>6mm</b>	x8	TS10, TS15, TS20, TS25, TS27, TS30, TS40, TS45
		x4	0, 1, 2, 3mm
		x3	6, 8, 10mm
	<b>6mm</b>	x4	4, 6, 8, 10mm
		x3	1, 2, 3mm
		x4	1, 2, 3, 4mm
	<b>6mm</b>	x1	1/4"



# CAIXA DE FERRAMENTAS DE 132 PEÇAS COM CHAVES HEXAGONAIS

54082 188,00€

CrV

132  
PCS

11.00	-	2	56
Kg	sub	ff	

**ESPECIAL  
AUTOMAÇÃO**



REPOSIÇÕES  
DISPONÍVEIS

## CONTÉM

	<b>1/2"</b>	x7	19,21, 22, 24, 27, 30, 32mm
	<b>3/8"</b>	x11	8, 9, 10, 11, 12, 13, 14, 15, 16, 17, 18, 19mm
	<b>1/4"</b>	x10	8, 9, 10, 11, 12, 13, 14, 15, 16, 17, 18, 19mm
	<b>3/8"</b>	x4	13, 14, 15, 17 mm
	<b>1/4"</b>	x4	8, 10, 12, 13mm
	<b>3/8"</b>	x6	E8, E10, E11, E14, E16, E20
	<b>1/2"</b>	x1	
	<b>3/8"</b>	x1	
	<b>1/4"</b>	x1	
	<b>1/2"</b>	x2	125, 250mm
	<b>3/8"</b>	x2	75, 150mm
	<b>1/4"</b>	x1	50mm
		x1	Ø14mm

		x1	3/8"(H)-1/2"(M)
		x1	3/8"(H)-1/2"(M)
		x1	3/8"(H)-1/4"(M)
	<b>1/2"</b>	x1	
	<b>3/8"</b>	x1	
	<b>1/4"</b>	x1	
	<b>1/2"</b>	x3	17, 19, 22mm
	<b>1/4"</b>	x1	6mm
		x1	
		x1	PH2x100
		x1	SL6x100
		x12	8, 9, 10, 11, 12, 13, 14, 15, 16, 17, 18, 19mm
		x1	

	<b>1/2"</b>	x1	H17
	<b>1/2"</b>	x1	21mm
	<b>3/8"</b>	x2	16, 18mm
	<b>1/2"</b>	x1	T52
	<b>1/2"</b>	x1	M16
		x2	5,5, 6,5mm
		x2	PH0, PH3
	<b>3/8"</b>	x2	PZ1, PZ3
		x4	4,5, 6,8mm
		x6	T20, T30, T40, T45, T50, T55
		x3	4,5, 6,5mm
		x3	PH1, PH2, PH3
	<b>6mm</b>	x3	PZ1, PZ2, PZ3
		x4	3,4, 5,6
		x7	T10, T15, T20, T25, T27, T30, T40
		x9	1,5, 2, 2,5, 3, 4, 5, 6, 8, 10mm
		x1	
		x1	

# CAIXA DE FERRAMENTAS DE 179 PEÇAS COM CHAVES HEXAGONAIS

**54035** 149,00€



ZINCADO

**54046** 150,00€



CROMADO

ACO  
S2

CrV

179  
PCS

**54035**



REPOSIÇÕES  
DISPONÍVEIS

**54046**



REPOSIÇÕES  
DISPONÍVEIS

ACO  
S2



## CONTÉM

	1/2" x17	10, 11, 12, 13, 14, 15, 16, 17, 18, 19, 20, 21, 22, 24, 27, 30, 32mm
	3/8" x10	10, 11, 12, 13, 14, 15, 16, 17, 18, 19mm
	1/4" x13	4, 4.5, 5, 5.5, 6, 7, 8, 9, 10, 11, 12, 13, 14mm
	1/2" x5	16, 17, 18, 19, 22mm
	3/8" x6	10, 11, 12, 13, 14, 15mm
	1/4" x7	4, 5, 6, 7, 8, 9, 10mm
	1/2" x2	E20, E24
	3/8" x6	E10, E11, E12, E14, E16, E18
	1/4" x5	E4, E5, E6, E7, E8
	T2	1/2" - 3/8" - 1/4"
	1/2" x1	125mm
	3/8" x1	125mm
	1/4" x2	50, 100mm
	1/2" x1	250mm

	x3	1/2" - 3/8" - 1/4"
	1/2" x2	16, 21mm
	3/8" x1	18mm
	1/2" x1	8mm
	3/8" x1	8mm
	1/4" x1	6mm
	x7	1,27, 1,5, 2, 2,5, 3, 4, 5mm
	x1	1/4"
	x1	1/4"
	x3	PH1, PH2, PH3
	x3	PZ1, PZ2, PZ3
	1/4" x5	2, 3, 4, 5, 6mm
	1/4" x3	SL4, SL5.5, SL7
	x8	T8, T9, T10, T15, T20, T25, T27, T30
	x8	T8, T9, T10, T15, T20, T25, T27, T30

	x11	T5, T6, T7, T8, T9, T10, T15, T20, T25, T27, T30
	x9	T7, T10, T15, T20, T25, T27, T30, T40, T45
	x5	M5, M6, M7, M8, M9
	x3	M5, M6, M8
	x2	PH3, PH4
	x2	PZ3, PZ4
	x8	7, 8, 10, 12, 14mm
	x3	SL8, SL10, SL12
	x6	T40, T45, T50, T55, T60, T70
	x6	T40, T45, T50, T55, T60, T70



# CAIXA DE FERRAMENTAS DE 113 PEÇAS

12 FACES XZN

**54036** 99,00€

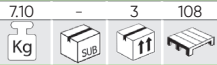

ZINCADO

**54047** 100,00€

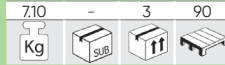

CROMADO

ACO S2

CrV

113 PCS

**54036**



REPOSIÇÕES DISPONÍVEIS

**54047**



REPOSIÇÕES DISPONÍVEIS

ACO S2

## CONTÉM

	<b>1/2"</b>	x17	10, 11, 12, 13, 14, 15, 16, 17, 18, 19, 20, 21, 22, 24, 27, 30, 32mm
	<b>1/4"</b>	x13	4, 4.5, 5, 5.5, 6, 7, 8, 9, 10, 11, 12, 13, 14mm
	<b>1/2"</b>	x5	14, 15, 17, 19, 22mm
	<b>1/4"</b>	x8	6, 7, 8, 9, 10, 11, 12, 13mm
	<b>1/2"</b>	x8	E10, E11, E12, E14, E16, E18, E20, E24
	<b>1/4"</b>	x5	E4, E5, E6, E7, E8
	<b>T2</b>	x2	1/2" - 1/4"
	<b>1/2"</b>	x2	125, 250mm
	<b>1/4"</b>	x2	50, 100mm

	x2	1/2" - 1/4"
	<b>1/2"</b>	x1 adaptador 3/8" H x 1/2" M
	<b>1/2"</b>	x1 8mm
	x5	7, 8, 10, 12, 14mm
	x3	SL8, SL10, SL12
	x2	PH3, PH4
	x2	PZ3, PZ4
	x5	T40, T45, T50, T55, T60
	x5	5, 6, 8, 10, 12mm

	<b>1/2"</b>	x2	16, 21mm
	x3	1.5, 2, 2.5mm	
	x1	1/4"	
	x1	1/4"	
	x2	PH1, PH2	
	x2	PZ1, PZ2	
	<b>1/4"</b>	x4	3, 4, 5, 6mm
	x3	SL4, SL5.5, SL6.5	
	x8	T8, T10, T15, T20, T25, T27, T30	

# CAIXA DE FERRAMENTAS DE 108 PEÇAS COM CHAVES HEXAGONAIS

**54037** 88,00€



ZINCADO

**54048** 89,00€



CROMADO

ACO  
S2

CrV

108  
PCS

54048



REPOSIÇÕES  
DISPONÍVEIS

54037



REPOSIÇÕES  
DISPONÍVEIS

ACO  
S2



## CONTÉM

	<b>1/2"</b> x17	10, 11, 12, 13, 14, 15, 16, 17, 18, 19, 20, 21, 22, 24, 27, 30, 32mm
	<b>1/4"</b> x13	4, 4.5, 5, 5.5, 6, 7, 8, 9, 10, 11, 12, 13, 14mm
	<b>1/2"</b> x5	14, 15, 17, 19, 22mm
	<b>1/4"</b> x8	6, 7, 8, 9, 10, 11, 12, 13mm
	<b>1/2"</b> x8	E10, E11, E12, E14, E16, E18, E20, E24
	<b>1/4"</b> x5	E4, E5, E6, E7, E8
	<b>T2</b> x2	1/2" - 1/4"
	<b>1/2"</b> x2	125, 250mm
	<b>1/4"</b> x2	50, 100mm
	x2	1/2" - 1/4"
	<b>1/2"</b> x1	adaptador 3/8" H x 1/2" M

	<b>1/2"</b> x2	16, 21mm
	<b>1/2"</b> x1	8mm
	x3	1.5, 2, 2.5mm
	x1	1/4"
	x1	1/4"
	x2	PH3, PH4
	x2	PZ3, PZ4
	<b>8mm</b> x5	7, 8, 10, 12, 14mm
	x3	SL8, SL10, SL12
	x5	T40, T45, T50, T55, T60

	x2	PH1, PH2
	x2	PZ1, PZ2
	<b>1/4"</b> x4	3, 4, 5, 6mm
	x3	SL4, SL5.5, SL6.5
	x8	T8, T10, T15, T20, T25, T27, T30



# CAIXA DE FERRAMENTAS DE 94 PEÇAS COM CHAVES HEXAGONAIS

54038

88,00€

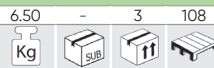

54049

88,00€

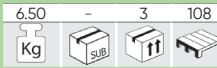

CrV

94  
PCS

ZINCADO

CROMADO

54049



REPOSIÇÕES  
DISPONÍVEIS

54038



REPOSIÇÕES  
DISPONÍVEIS



ACO  
S2

## CONTÉM

	1/2" x18	10, 11, 12, 13, 14, 15, 16, 17, 18, 19, 20, 21, 22, 23, 24, 27, 30, 32mm
	1/4" x13	4, 4.5, 5, 5.5, 6, 7, 8, 9, 10, 11, 12, 13, 14mm
	1/2" x4	14, 15, 17, 19mm
	1/4" x8	6, 7, 8, 9, 10, 11, 12, 13mm
	72 x2	1/2" - 1/4"
	1/2" x2	125, 250mm
	1/4" x2	50, 100mm
	x2	1/2" - 1/4"
	1/2" x1	adaptador 3/8" H x 1/2" M

	1/2" x1	8mm
	x3	1.5, 2, 2.5mm
	1/2" x2	16, 21mm
	x2	PH3, PH4
	x2	PZ3, PZ4
	8mm x4	8, 10, 12, 14mm
	x3	SL8, SL10, SL12
	x4	T40, T45, T50, T55
	8mm x1	1/4"

	x1	1/4"
	x1	1/4"
	x1	1/4"
	x2	PH1, PH2
	x2	PZ1, PZ2
	1/4" x4	3, 4, 5, 6mm
	x3	SL4, SL5.5, SL7
	x6	T8, T10, T15, T20, T25, T30

# CAIXA DE FERRAMENTAS DE 303 PEÇAS COM CHAVES HEXAGONAIS

53212 149,00€

945 - 2 48  
Kg SUB 11

CROMADO



REPOSIÇÕES DISPONÍVEIS



CrV 303 PCS

1/2" 1/4"



## CONTÉM

	1/2"	x18	10, 11, 12, 13, 14, 15, 16, 17, 18, 19, 20, 21, 22, 23, 24, 27, 30, 32mm
	1/4"	x13	4, 4.5, 5, 5.5, 6, 7, 8, 9, 10, 11, 12, 13, 14mm
	1/2"	x2	1/2" - 1/4"
	1/2"	x2	125, 250mm
	1/4"	x2	50, 100mm
	1/2"	x1	8mm
	1/4"	x1	6mm
	1/2"	x1	adaptador 3/8" H x 1/2" M
	1/2"	x2	16, 21mm
		x2	1/2" - 1/4"
		x1	1/4"
		x2	SL3.0 x 50mm, SL2.5 x 50mm
		x3	PH0x50mm, PH00x50mm, PH000x50mm
		x2	SL4.0x100mm, SL6.5x125mm
		x2	PH1x80mm, PH2x100mm

	6mm	x9	1.5, 2, 2.5, 3, 4, 5, 5.5, 6, 8mm
	6mm	x10	1/16, 5/64, 3/32, 7/64, 1/8, 9/64, 5/32, 3/16, 7/32, 1/4
	8mm	x4	H5.5, H6.5, H7, H8
	6mm	x6	5/64, 3/32, 7/64, 1/8, 9/64, 5/32
	6mm	x6	2, 2.5, 3, 4, 5, 6mm
	6mm	x9	SL3, SL4, SL4.5, SL5, SL5.5, SL6, SL6.5, SL7, SL8
	8mm	x4	SL5.5, SL6.5, SL7, SL8
	6mm	x10	PH0 (x2), PH1 (x2), PH2 (x4), PH3 (x2)
	8mm	x2	PH3, PH4
	6mm	x10	PZ0 (x2), PZ1 (x2), PZ2 (x4), PZ3 (x2)
	8mm	x2	PZ3, PZ4
	6mm	x10	T8, T10, T15, T20, T25, T27, T30, T35, T40, T45
	8mm	x8	T25, T27, T30, T35, T40 (x2), T45, T50
	6mm	x9	T8, T10, T15, T20, T25, T27, T30, T35, T40
	6mm	x3	5, 6, 8mm
	8mm	x4	5, 6, 8, 10mm

	6mm	x3	6, 8, 10
	6mm	x3	C1, C2, C3
	6mm	x4	1, 2, 3, 4
	6mm	x4	4, 6, 7, 10mm
	6mm	x4	S0, S1, S2, S3
	6mm	x7	1, 2, 2.5, 3, 4, 5mm
	6mm	x13	1.5, 2, 2.5, 3, 3.2, 3.5, 4, 4.5, 4.8, 5, 5.5, 6, 6.5mm
	6mm	x1	
	6mm	x1	
	6mm	x10	
	6mm	x1	8"
	6mm	x1	3m
	6mm	x6	SL1.5, SL2, SL2.5, SL3, SL3.5, SL4
	6mm	x4	PH000, PH00, PH0, PH1
	6mm	x2	PZ0, PZ1
	6mm	x8	T5, T6, T7, T8, T9, T10, T15, T20
	6mm	x1	
	6mm	x23	
	6mm	x22	
	6mm	x10	
	6mm	x10	

# CAIXA FERRAMENTAS DE 82 PEÇAS COM CHAVES HEXAGONAIS

53647 96,00€

6.13 - 3 108  
Kg SUB 11

CROMADO



REPOSIÇÕES DISPONÍVEIS



CrV 82 PCS

1/2" 1/4"



## CONTÉM

	1/2"	x12	13, 14, 15, 16, 17, 18, 19, 22, 24, 27, 30, 32mm
	1/4"	x13	4, 4.5, 5, 5.5, 6, 7, 8, 9, 10, 11, 12, 13, 14mm
	1/2"	x2	1/2" - 1/4"
	1/2"	x2	125, 250mm
	1/4"	x2	50, 100mm
	1/2"	x2	1/2" - 1/4"
	1/2"	x1	adaptador 3/8" H x 1/2" M

	1/2"	x2	16, 21mm
	1/2"	x1	8mm
		x9	8, 10, 11, 12, 13, 14, 17, 19, 22mm
		x1	150mm
		x1	1/4"
		x1	1/4"

	8mm	x2	PH3, PH4
	8mm	x2	PZ3, PZ4
	8mm	x4	8, 10, 12, 14mm
	8mm	x3	SL8, SL10, SL12
	8mm	x4	T40, T45, T50, T55
	8mm	x1	1/4"
	1/4"	x2	PH1, PH2
	1/4"	x2	PZ1, PZ2
	1/4"	x4	3, 4, 5, 6mm
	1/4"	x3	SL4, SL5.5, SL7
	1/4"	x6	T8, T10, T15, T20, T25, T30



## CAIXA DE FERRAMENTAS DE 74 PEÇAS COM CHAVES DE 12 FACES

53074 78,00€

5,09 - 3 108



CROMADO



REPOSIÇÕES  
DISPONÍVEIS



74  
PCS

CrV

1/2"

1/4"

### CONTÉM

	<b>1/2"</b>	x18	10, 11, 12, 13, 14, 15, 16, 17, 18, 19, 20, 21, 22, 23, 24, 27, 30, 32mm
	<b>1/4"</b>	x10	4, 5, 5.5, 6, 7, 8, 10, 11, 12, 13mm
		x2	1/2" - 1/4"
	<b>1/2"</b>	x2	125, 250mm
	<b>1/4"</b>	x1	100mm
		x1	1/2"

	<b>1/2"</b>	x1	adaptador 3/8" H x 1/2" M
	<b>1/2"</b>	x1	21mm
		x3	1.5, 2, 2.5mm
		x1	1/4"
	<b>1/4"</b>	x1	6mm

		x5	PH0, PH1, PH2, PH3, PH4
		x5	PZ0, PZ1, PZ2, PZ3, PZ4
		x6	3, 4, 5, 6, 8, 10mm
		x5	SL3, SL4, SL5.5, SL6, SL7
		x8	T8, T10, T15, T20, T25, T27, T30, T40
		x4	4, 5, 6, 7mm

## CAIXA FERRAMENTAS 3/8" DE 59 PEÇAS COM CHAVES DE 12 FACES

54168 49,00€

2,60 - 10 180



REPOSIÇÕES  
DISPONÍVEIS



59  
PCS

CrV

3/8"

### CONTÉM

	<b>3/8"</b>	x17	6, 7, 8, 9, 10, 11, 12, 13, 14, 15, 16, 17, 18, 19, 20, 21, 22mm
		x1	3/8"
	<b>3/8"</b>	x2	75, 150mm
	<b>3/8"</b>	x1	8mm
	<b>3/8"</b>	x1	8mm

		x1	3/8"
		x2	PH3, PH4
		x2	PZ3, PZ4
		x5	7, 8, 10, 12, 14mm
		x3	8, 10, 12mm
		x5	T40, T45, T50, T55, T60

		x1	1/4"
		x2	PH1, PH2
		x2	PZ1, PZ2
		x4	3, 4, 5, 6mm
		x3	4, 5.5, 6.5mm
		x7	T8, T10, T15, T20, T25, T27, T30

## CAIXA DE FERRAMENTAS COM 56 PEÇAS

54105 33,00€

1,25 - 10 300



REPOSIÇÕES  
DISPONÍVEIS



CrV

56  
PCS

### CONTÉM

	<b>1/4"</b>	x13	4, 4.5, 5, 5.5, 6, 7, 8, 9, 10, 11, 12, 13, 14mm
		x1	1/4"
	<b>1/4"</b>	x2	50, 100mm
		x1	1/4"
		x1	1/4"

		x4	SL4, SL5, SL6, SL7
		x3	M5, M6, M8
		x8	T8, T10, T15, T20, T25, T27, T30, T40
		x8	T8, T10, T15, T20, T25, T27, T30, T40
		x1	1/4"
	<b>1/4"</b>	x1	6mm
		x3	PH0, PH1, PH2
		x3	PZ0, PZ1, PZ2
		x6	3, 4, 5, 6, 7, 8mm
	<b>6mm</b>	x1	1/4"

# CONJUNTO DE BITS E CHAVES DE CAIXA

DE 130 PCS

**53953** 29,00€

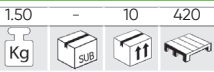

ZINCADO

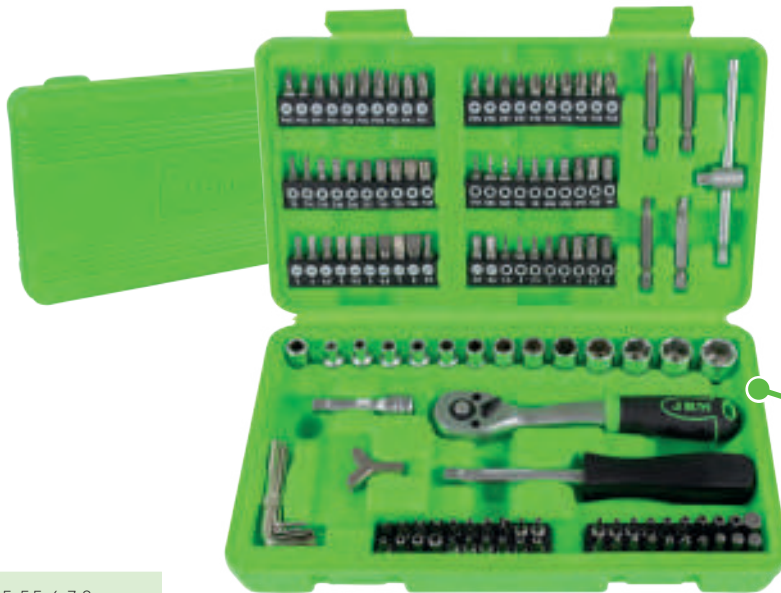
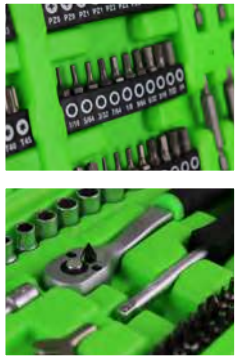

CrV 1/4" 130 PCS



REPOSIÇÕES DISPONÍVEIS



EM EXPOSITOR DE 10 UDS

CONTÉM

	1/4" x13	4, 4.5, 5, 5.5, 6, 7, 8, 9, 10, 11, 12, 13, 14mm
	72 x1	1/4"
	1/4" x1	50mm
	x1	1/4"
	1/4" x1	6mm
	x1	1/4"
	x1	1/4"
	1/4" x7	1,27, 1.5, 2, 2.5, 3, 4, 5mm

	25mm x10	1/16, 5/64, 3/32, 7/64, 1/8, 9/64, 5/32, 3/16, 7/32, 1/4
	x9	1.5, 2, 2.5, 3, 4, 5, 5.5, 6, 8mm
	25mm x6	5/64, 3/32, 7/64, 1/8, 9/64, 5/32
	x6	2, 2.5, 3, 4, 5, 6mm
	25mm x9	3, 4, 4.5, 5, 5.5, 6, 6.5, 7, 8mm
	50mm x2	4, 6mm
	25mm x10	PH0(x2), PH1(x2), PH2(x4), PH3(x2)
	50mm x2	PH1, PH2
	25mm x10	PZ0(x2), PZ1(x2), PZ2(x4), PZ3(x2)

	25mm x10	T8, T10, T15, T20, T25, T27, T30, T35, T40, T45
	25mm x9	T8, T10, T15, T20, T25, T27, T30, T35, T40
	25mm x3	M5, M6, M8
	25mm x3	6, 8, 10mm
	25mm x3	C1, C2, C3
	25mm x4	1, 2, 3, 4mm
	25mm x4	4, 6, 8, 10mm
	25mm x4	0, 1, 2, 3mm

# CAIXA DE FERRAMENTAS 3/8" DE 59 PEÇAS COM CHAVES HEXAGONAIS

**51819** 48,00€

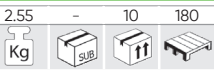

ZINCADO

**53219** 49,00€

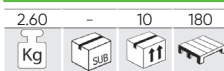

CROMADO

CrV 3/8" 59 PCS



REPOSIÇÕES DISPONÍVEIS



REPOSIÇÕES DISPONÍVEIS

CONTÉM

	3/8" x17	6, 7, 8, 9, 10, 11, 12, 13, 14, 15, 16, 17, 18, 19, 20, 21, 22mm
	72 x1	3/8"
	3/8" x2	75, 150mm
	3/8" x1	8mm
	3/8" x1	8mm

	x1	3/8"
	x2	PH3, PH4
	x2	PZ3, PZ4
	8mm x5	7, 8, 10, 12, 14mm
	x3	SL8, SL10, SL12
	x5	T40, T45, T50, T55, T60

	x1	1/4"
	x2	PH1, PH2
	x2	PZ1, PZ2
	1/4" x4	3, 4, 5, 6mm
	x3	SL4, SL5.5, SL6.5
	x7	T8, T10, T15, T20, T25, T27, T30



## CAIXA DE FERRAMENTAS DE 22 PEÇAS COM CHAVES DE 1/2"

54116

66,00€

3,95	-	4	96
Kg	Sub	11	16



CrV 1/2"

22  
PCS



REPOSIÇÕES  
DISPONÍVEIS



12 VIAS

CONTÉM

		1/2"	x17	10, 11, 12, 13, 14, 15, 16, 17, 18, 19, 21, 22, 24, 27, 30, 32mm
		1/2"	x1	1/2"
		1/2"	x2	125, 250mm
		1/2"	x1	
		1/2"	x1	3/8"(H), 1/2"(M)

## CAIXA DE FERRAMENTAS COM 46 PEÇAS - COM CHAVES HEXAGONAIS

54109

34,00€

1,40	-	10	360
Kg	Sub	11	16



CrV 1/4"

46  
PCS



REPOSIÇÕES  
DISPONÍVEIS



CONTÉM

		1/4"	x13	4, 4.5, 5, 5.5, 6, 7, 8, 9, 10, 11, 12, 13, 14mm
		1/4"	x1	
		1/4"	x1	1/4"
		1/4"	x1	1/4"
		2"/4"	x2	
			x4	1,27, 1,5, 2,0, 2,5mm
			x1	
			x1	1/4"

## CAIXA DE FERRAMENTAS COM 56 PEÇAS

53102

36,00€

1,28	-	10	270
Kg	Sub	11	16



CrV 1/4"

56  
PCS



REPOSIÇÕES  
DISPONÍVEIS



CONTÉM

		1/4"	x13	4, 4.5, 5, 5.5, 6, 7, 8, 9, 10, 11, 12, 13, 14mm
		1/4"	x1	1/4"
		1/4"	x2	50, 100mm
			x1	1/4"
			x1	1/4"

CROMADO

		1/4"	x1	
		1/4"	x1	6mm
			x3	PH0, PH1, PH2
		6mm	x3	PZ0, PZ1, PZ2
			x6	3, 4, 5, 6, 7, 8mm
		6mm	x1	1/4"

54140

36,00€

1,28	-	10	300
Kg	Sub	11	16



CrV 1/4"

56  
PCS



REPOSIÇÕES  
DISPONÍVEIS

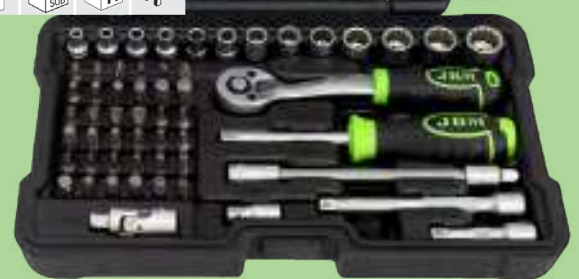

			x4	SL4, SL5, SL6, SL7
		6mm	x3	M5, M6, M8
			x8	T8, T10, T15, T20, T25, T27, T30, T40
			x8	T8, T10, T15, T20, T25, T27, T30, T40

## CAIXA DE FERRAMENTAS DE 35 PEÇAS EM POLEGADA

54106 89,00€

4.70	-	3	108
Kg	sub	ff	



### CONTÉM

	1/2"	x17	5/16", 3/8", 7/16", 1/2", 9/16", 19/32", 5/8", 11/16", 3/4", 13/16", 7/8", 15/16", 1", 1-1/16", 1-1/8", 1-3/16", 1-1/4", 3/16", 7/32", 1/4", 9/32", 5/16", 11/32", 3/8", 7/16"
	1/2"	x2	5", 10"
	1/4"	x1	3"
		x1	1/2"
		x1	1/4"
		x2	1/2" - 1/4"
		x1	1/4"

37 PCS

1/4"

1/2"

CrV



## CAIXA DE FERRAMENTAS DE 22 PEÇAS COM CHAVES DE 1/2"

54108 66,00€

3.95	-	4	128
Kg	sub	ff	



### CONTÉM

	1/2"	x16	10, 11, 12, 13, 14, 15, 16, 17, 18, 19, 21, 22, 24, 27, 30, 32mm
	1/2"	x1	
	1/2"	x2	75, 125mm
		x1	3/8"(H)-1/2"(M)

22 PCS

1/2"

CrV



## CAIXA DE FERRAMENTAS DE 61 PEÇAS SPLINE CHAVES SPLINE DE 1/4" E 1/2"

52722 87,00€

4.63	-	4	60
Kg	sub	ff	

1/2" 1/4"

ZINCADO



53108 92,00€

4.83	-	3	90
Kg	sub	ff	

1/2" 1/4" CrV 61 PCS

- Útil para:



CROMADO



### CONTÉM

	1/2"	x11	14, 15, 16, 17, 18, 19, 22, 24, 27, 30, 32mm
	1/4"	x12	4, 4.5, 5, 5.5, 6, 7, 8, 9, 10, 11, 12, 13mm
	1/2"	x2	125, 250mm
	1/4"	x2	50, 100mm
		x2	1/2" - 1/4"
	1/2"	x1	adaptador 3/8" H x 1/2" M
	1/2"	x2	16, 21mm
	1/4"	x1	6mm
		x3	1.5, 2, 2.5mm
		x1	1/4"
		x1	1/4"

		x3	PH1, PH2, PH3
		x3	PZ1, PZ2, PZ3
	6mm	x5	3, 4, 5, 6, 8mm
		x3	SL4, SL5.5, SL7
		x5	T10, T15, T20, T25, T30
	6mm	x1	1/4"

## CAIXA DE FERRAMENTAS DE 77 PEÇAS

54258 58,00€

7.50	-	4	-
Kg	sub	ff	



### CONTÉM

	x5	PH0, PH1, PH2, PH2, PH3
	x5	PZ0, PZ1, PZ2, PZ2, PZ3
	x5	3, 4, 5, 5.5, 6mm
	x5	T10, T15, T20, T25, T30
	X4	6x7mm, 8x9mm, 10x11mm, 12x13mm
	X9	1.5, 2, 2.5, 3, 4, 5, 6, 8, 10mm
	X10	
	X10	

	X1	
	X1	
	X1	
	X1	
	X1	
	X1	
	X1	
	X3	PH2X100, PH00X50, PH00X50, SL6X100
	X3	SL2.5X50, SL3.0X50

CrV 77 PCS



# CAIXA DE FERRAMENTAS DE 72 PEÇAS COM CHAVES HEXAGONAIS

**51818**

95,00€

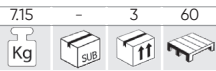

ZINCADO

**53106**

99,00€



CROMADO



CrV

72  
PCS

1/2"

1/4"



53106



REPOSIÇÕES  
DISPONÍVEIS

51818



REPOSIÇÕES  
DISPONÍVEIS

## CONTÉM

	1/2"	x13	10, 11, 12, 13, 14, 15, 17, 19, 22, 24, 27, 30, 32mm		x2	1/2" - 1/4"		x1		
	1/4"	x10	4, 5, 6, 7, 8, 9, 10, 11, 12, 13mm		1/2"	x2	16, 21mm		x1	300gr
	1/4"	x5	5, 6, 7, 8, 9mm		1/4"	x1	6mm		x1	
	ref. 53106	72	x2	1/2", 1/4"		x8	10, 11, 12, 13, 14, 15, 17, 19mm		x1	
	ref. 51818	24	x2	1/2", 1/4"		x3	1.5, 2, 2.5mm		x1	
	1/2"	x1	125mm		x1	1/4"			x4	SL3, SL4, SL5, SL6
	1/4"	x1	75mm		x2	PH6x40mm, PH6x100mm			x3	PH1, PH2, PH3
					x3	SL6x40mm, SL6x100mm, SL8x200mm			x7	T10, T15, T20, T25, T27, T30, T40

# CAIXA DE FERRAMENTAS DE 41 PEÇAS COM CHAVES HEXAGONAIS

**52713**

89,00€



ZINCADO



CrV

41  
PCS

1/2"



REPOSIÇÕES  
DISPONÍVEIS

## CONTÉM

	1/2"	x11	10, 12, 13, 14, 15, 17, 19, 22, 24, 27, 30mm		x1	6"
	1/2"	x2	16, 21mm		x1	20x200mm
	24	x1	1/2"		x1	6-24V, 110mm
	1/2"	x1	125mm		x1	8"
	1/2"	x1			x2	8x10, 12x13mm
	1/2"	x1	adaptador 3/8" H x 1/2" M		x1	8x10mm
	1/2"	x8	7, 8, 10, 12, 13, 14, 17, 19mm		x1	75x300mm
		x4	6, 8, 10, 12mm		x1	300gr
	+	x1	PH2x100mm		x1	6x150mm
	-	x1	SL6x100mm			

# CAIXAS DE FERRAMENTAS DE ALUMÍNIO

## MALA CAIXA DE FERRAMENTAS DE ALUMÍNIO 159PCS

53159 289,00€

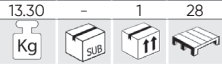

CrV

1/2"

1/4"

159  
PCS

ZINCADO



REPOSIÇÕES  
DISPONÍVEIS



### CONTÉM



	1/2"	x14	14, 15, 16, 17, 18, 19, 20, 21, 22, 23, 24, 27, 30, 32mm
	1/4"	x10	4, 5, 6, 7, 8, 9, 10, 11, 12, 13mm
	12	x2	1/4" - 1/2"
	1/2"	x2	50, 100mm
	1/4"	x2	125, 250mm
	1/4"	x1	150mm
		x2	1/4" - 1/2"
	1/2"	x1	adaptador 3/8" H x 1/2" M
		x2	1/4" - 1/2"
	1/4"	x1	250mm
	1/4"	x1	110mm
	1/2"	x2	16, 21mm
		x1	1/4"

	x9	8, 10, 11, 12, 13, 15, 17, 19, 22mm	
	x9	1.5, 2, 2.5, 3, 4, 5, 6, 8, 10mm	
	x1	100-250V	
	x1		
	+	x2	PH1x80, PH2x10mm
	-	x4	SL3x75, SL4x100, SL6.5x125, SL8x150mm
	+	x1	PH00x50mm
	-	x1	SL2.5x50mm
	x1	250mm	
	x1	200mm	
	x1	160mm	
	x1	180mm	
	x1	160mm	
	x1	220mm	
	x1	7" (180mm)	
	x1	160mm	

	x1	
	x6	1,5mm
	x1	
	x1	300gr
	x1	3m
	x1	200mm
	x5	
	x1	18mm
	x10	
	x40	6.35mm
	x15	8mm



# CAIXAS DE FERRAMENTAS DE ALUMÍNIO

## CAIXA DE FERRAMENTAS DE 135 PEÇAS COM CHAVES HEXAGONAIS

53928 278,00€

13,50	-	1	32
Kg	Sub	11	11

1/2" 1/4" 135 PCS

CrV 











REPOSIÇÕES DISPONÍVEIS















### CONTÉM









	x1	250mm
	x1	180mm
	x1	180mm
	x1	200mm
	x1	160mm
	x1	200mm
	x1	
	x3	
	x1	18mm



















	1/2"	x10	10, 11, 12, 13, 14, 15, 17, 19, 22, 24mm
	1/4"	x9	4, 5, 6, 7, 8, 9, 10, 11, 12mm
	72	x2	1/2" - 1/4"
	1/2"	x2	125, 250mm
	1/4"	x2	50, 100mm
	1/2"	x2	1/2" - 1/4"
	1/2"	x1	adptador 3/8" H x 1/2" M
		x1	1/4"
	1/4"	x1	6mm
	1/2"	x2	16, 21mm
		x9	8, 10, 11, 12, 13, 14, 17, 19, 22mm
		x1	150mm



	x1	
	x1	
	x1	100-250v
	x1	
	x1	300gr.
	x1	
	x1	5m



	x1	
	x3	SL1.5, SL2, SL3
	x4	PH000, PH00, PH0, PH1
	x8	T4, T5, T6, T7, T8, T10, T15, T20
	x4	TS0.8, TS1.2, TS1.5, TS2.0
	x1	H2.0
	x9	1.5, 2, 2.5, 3, 4, 5, 6, 8, 10mm
	x2	PH1x80mm, PH2x100mm
	x4	SL3.0x75mm, SL4.0x100mm, SL6.5x125mm, 8x150mm
	x5	

	x1	
	x1	6.35mm
	x4	PH1, PH2, PH2, PH3
	x4	PZ1, PZ2, PZ2, PZ3
	x4	SL3, SL4, SL5, SL6
	x4	H3, H4, H5, H6
	x6	T10, T15, T20, T25, T27, T30, T40
	x7	TT10, TT15, TT20, TT25, TT27, TT30, TT40

# CAIXAS DE FERRAMENTAS DE ALUMÍNIO

## CAIXA DE FERRAMENTAS DE ALUMÍNIO 108PCS

53444 195,00€

8.20 - 1 36  
Kg SUB if



CrV

108  
PCS

1/2"

3/8"

1/4"

ZINCADO



REPOSIÇÕES  
DISPONÍVEIS

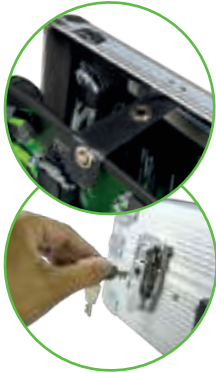

### CONTÉM



	1/4"	x8	4, 4.5, 5, 5.5, 6, 7, 8, 9mm
	3/8"	x9	10, 11, 12, 13, 14, 15, 17, 18, 19mm
	1/2"	x1	
	72	x1	1/2"
	3/8"	x2	75, 150mm
	1/2"	x2	75, 150mm
	1/4"	x1	adaptador 3/8" H x 1/4" M
	1/4"	x1	25mmL
	1/4"	x1	1/4"

	3/8"	x1	16mm
		x8	6x7, 8x9, 10x11, 12x13, 14x15, 16x17, 18x19, 20x22mm
		x9	1.5, 2, 2.5, 3, 4, 5, 6, 8, 10mm
	+	x2	PH1x80, PH2x100mm
	-	x4	SL3.5x75, SL4x100, SL6.5x125, SL8x150mm
	+	x1	PH00x50mm
	-	x1	SL2.5x50mm

	x1	100-250V		x1	
	x1	250mm		x6	1,5mm
	x1	180mm		x1	300gr
	x1	160mm		x31	
	x1	160mm		x1	
	x1	220mm		x1	7"
	x1	18mm		x1	3m
	x10				



## CAIXA DE FERRAMENTAS COM 22 PEÇAS AUTOCLER 1" HEXAGONAIS

**51616** 378,00€

34,60 - 1 24

Kg SUB 1 1 1



**51855** 378,00€

33,70 - 1 24





Kg SUB 1 1 1

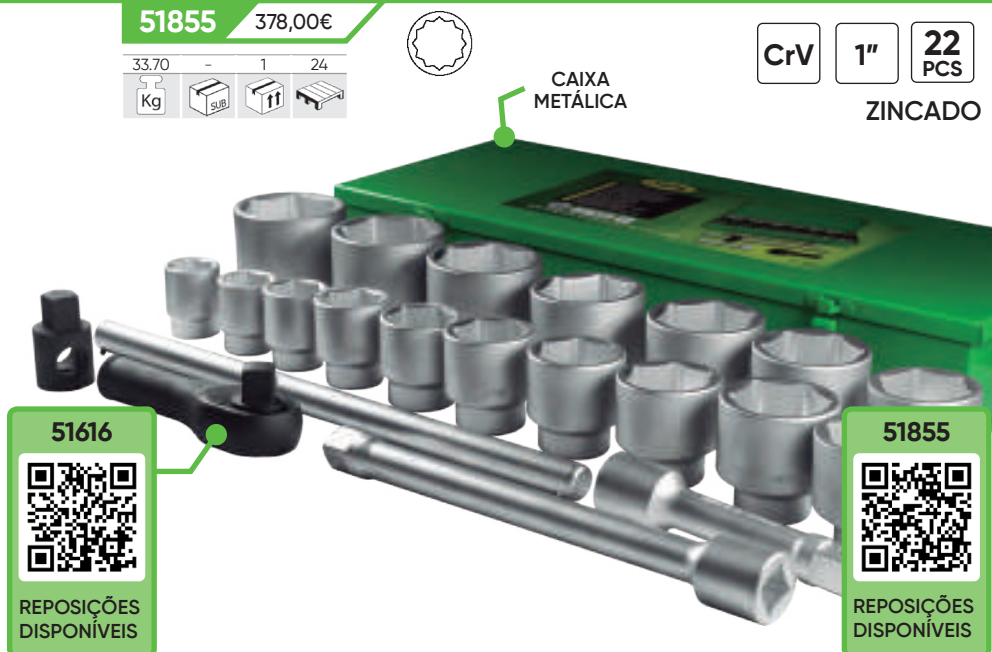

CrV 1" 22 PCS  
ZINCADO



**CONTÉM**

	1"	x17	36, 38, 41, 46, 50, 54, 55, 58, 60, 63, 65, 67, 70, 71, 75, 77, 80mm
	1"	x1	650mm
	1"	x2	205, 410mm
	x1 1"		 x1 1"

**51616**



REPOSIÇÕES DISPONÍVEIS

**51855**



REPOSIÇÕES DISPONÍVEIS

## CAIXA DE FERRAMENTAS COM 21 PEÇAS DE AUTOCLER DE 3/4"

**53727** 198,00€

14,65 - 1 40

Kg SUB 1 1 1



CrV 3/4" 21 PCS  
ZINCADO





**53728** 198,00€

14,30 - 1 40

Kg SUB 1 1 1



**CONTÉM**

	3/4"	x16	19, 21, 22, 23, 24, 26, 27, 29, 30, 32, 35, 36, 38, 41, 46, 50mm
	3/4"	x1	495mm
	3/4"	x3	100, 200, 400mm
	3/4"	x1	445mm



**53728**



REPOSIÇÕES DISPONÍVEIS

**53727**



REPOSIÇÕES DISPONÍVEIS

## CAIXA DE FERRAMENTAS DE 39 PEÇAS HEX. DE PERFIL BAIXO





**52418** 164,00€

3,61 - 5 100

Kg SUB 1 1 1

CrV 39 PCS  
CROMADO

**CONTÉM**

	13mm	x12	4, 4, 5, 5, 5, 6, 7, 8, 9, 10, 11, 12, 13mm
	19mm	x10	10, 11, 12, 13, 14, 15, 16, 17, 18, 19mm
	22mm	x5	20, 21, 22, 23, 24mm
	22mm - 1/2"	x3	27, 30, 32mm
	1/4"	x3	13, 19, 22mm
	1/4"	x1	13mm
	3/8"	x1	19mm
	1/2"	x1	22mm
	72	x3	13, 19, 22mm



## CAIXA DE FERRAMENTAS DE 14 PEÇAS GO-THROUGH

54090 56,00€

14 PCS

2.00	-	10	240
Kg	SUB	11	11



### CONTÉM

	x11	13, 14, 15, 16, 17, 18, 19, 21, 22, 24, 27mm
	x1	12,5mm
	x1	1/2"
	x1	go-through

## CAIXA DE FERRAMENTAS DE 17 CHAVES PARA PARAFUSOS COMPRIDOS

50623 60,00€



CrV

1/4"

17 PCS

CROMADO

0.63	-	10	320
Kg	SUB	11	11



OCUPA UM ESPAÇO MÍNIMO

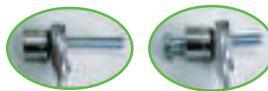

### CONTÉM

	13mm x13	4, 4.5, 5, 5.5, 6, 7, 8, 9, 10, 11, 12, 13, 14mm
	13mm x1	75mm
	x1	1/4"
	13mm x1	145mm



## CONJUNTO DE BITS TORX DE 6 PEÇAS 1/2" TIPO E EXTRA LONGOS

53915 65,00€

CrV

1/2"

6 PCS

2.10	-	10	240
Kg	SUB	11	11

ZINCADO

### CONTÉM

	1/2"	x6	E10, E12, E14, E16, E18, E20
--	------	----	------------------------------

E12 Soquete para cabeça do bloco de cilindros BMW:  
 - Motor M42, 1,8 L, 4 cilindros, 16 V, modelo 318 (1989)  
 - Motor M50, 2.0L, 2.5L, 6 cilindros, 24V, modelos 520i, 525i (1991)



CABEÇAL COM ACABAMENTOS EM PRETO



## CAIXA DE 28 CHAVES TORX

51930 39,00€

CrV

1/2"

3/8"

1/4"

28 PCS

2.12	-	10	240
Kg	SUB	11	11

### CONTÉM

	1/4"	x5	25mm	E4, E5, E6, E7, E8
	3/8"	x5	28mm	E10, E11, E12, E14, E16
	1/2"	x4	38mm	E18, E20, E22, E24
	1/4"	x5	50mm	E4, E5, E6, E7, E8
	3/8"	x5	63mm	E10, E11, E12, E14, E16
	1/2"	x4	76mm	E18, E20, E22, E24

51930



REPOSIÇÕES DISPONÍVEIS

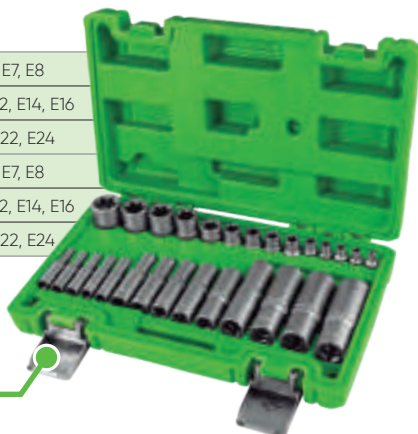

ZINCADO

54141 42,00€

CrV

1/2"

3/8"

1/4"

28 PCS

2.15	-	10	240
Kg	SUB	11	11



REPOSIÇÕES DISPONÍVEIS

	1/4"	x5	25mm	E4, E5, E6, E7, E8
	3/8"	x5	28mm	E10, E11, E12, E14, E16
	1/2"	x4	38mm	E18, E20, E22, E24
	1/4"	x5	50mm	E4, E5, E6, E7, E8
	3/8"	x5	63mm	E10, E11, E12, E14, E16
	1/2"	x4	76mm	E18, E20, E22, E24





## CAIXA DE 12 PEÇAS 1/2" PONTA DE TORX

51261 36,00€

1.62 - 10 360



ZINCADO



CROMADO

	1/2"	x6	T20, T25, T30, T40, T45, T50
		x1	T55
		x5	T60, T70, T80, T90, T100



REPOSIÇÕES DISPONÍVEIS

54154 37,50€

1.85 - 10 320



CrV

1/2"

12 PCS

55 mm

70 mm

ZINCADO



CONTÉM

	1/2"	x6	T20, T25, T30, T40, T45, T50
		x6	T55, T60, T70, T80, T90, T100

## CAIXA DE 12 PEÇAS 1/2" 12 FACES

51384 34,00€

1.62 - 10 360



ZINCADO



53104 34,00€

1.75 5 10 240



CROMADO

CONTÉM

	1/2"	x6	M4, M5, M6, M7, M8, M9
		x1	M10
		x5	M12, M14, M16, M18, M20

54164 34,00€

1.75 - 10 320



CrV

1/2"

12 PCS



CONTÉM

	1/2"	x6	M4, M5, M6, M7, M8, M9
		x6	M10, M12, M14, M16, M18, M20

## CAIXA DE 12 PEÇAS 1/2" HEXAGONAL

51260 37,00€

1.92 - 10 360



ZINCADO

51260



REPOSIÇÕES DISPONÍVEIS



CrV

1/2"

12 PCS



53105 37,00€

2.05 - 10 240



CROMADO

CONTÉM

	1/2"	x6	H5, H6, H7, H8, H10, H12
		x1	H14
		x5	H16, H17, H18, H19, H22

## SET DE 6 PEÇAS 1/2" PONTA TORX INTERIOR

51410 36,00€

0.38 5 20 500



T55, T60, T70, T80, T90, T100

1/2"

CrV

6 PCS



## SET DE 6 PEÇAS 1/2" 12 FACES INTERIOR / PONTA XZN

51409 36,00€

0.35 5 20 -



M10, M12, M14, M16, M18, M20

1/2"

CrV

6 PCS



# JOGO DE PONTAS 12 FACES

**52603** 74,00€



**26**  
PCS

4,07	-	4	128
Kg	sub	ff	



## CONTÉM

1/2"	x8	M5, M6, M8, M9, M10, M12, M14, M16
	x7	M5, M6, M8, M9, M10, M12, M14
	x7	M5, M6, M8, M9, M10, M12, M14
	x4	M8, M10, M12, M14



REPOSIÇÕES DISPONÍVEIS

**52606** 88,00€



**32**  
PCS

5,05	-	4	128
Kg	sub	ff	



## CONTÉM

1/2"	x9	M5, M6, M7, M8, M9, M10, M12, M13, M14
	x9	M5, M6, M7, M8, M9, M10, M12, M13, M14
	x7	M7, M8, M9, M10, M12, M13, M14
	x7	M7, M8, M9, M10, M12, M13, M14



REPOSIÇÕES DISPONÍVEIS

# JOGO DE PONTAS HEXAGONAIS

**52604** 78,00€



**30**  
PCS

4,62	-	4	144
Kg	sub	ff	



## CONTÉM

1/2"	x9	5, 6, 7, 8, 10, 12, 14, 17, 19mm
	x8	5, 6, 7, 8, 10, 11, 12, 13mm
	x7	5, 6, 7, 8, 10, 12, 14mm
	x6	5, 6, 7, 8, 10, 12mm



REPOSIÇÕES DISPONÍVEIS

**52605** 76,00€



**32**  
PCS

4,60	-	4	144
Kg	sub	ff	



## CONTÉM

1/2"	x10	T20, T25, T27, T30, T40, T45, T50, T55, T60, T70
	x10	T20, T25, T27, T30, T40, T45, T50, T55, T60, T70
	x6	T40, T45, T50, T55, T60, T70
	x6	T40, T45, T50, T55, T60, T70



REPOSIÇÕES DISPONÍVEIS



# CAIXA FERRAMENTAS DE 55 PONTAS HEAVY DUTY

52753 107,00€

2,96 - 4 184



S-2 3/8" 1/2" 55 PCS

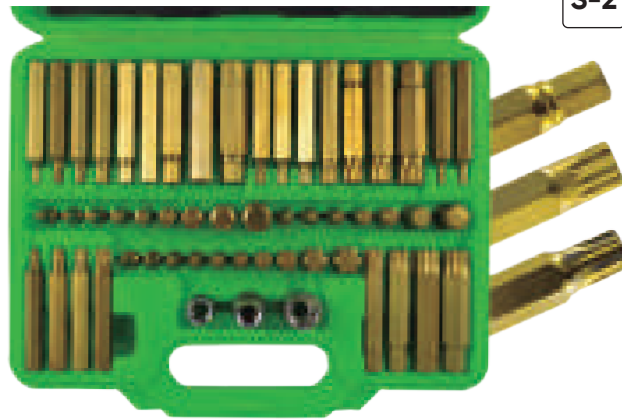

## CONTÉM

	<b>3/8"</b>	x1	10mm
	<b>1/2"</b>	x2	10, 14mm
	30mm	x9	4, 5, 6, 7, 8, 10, 12, 14, 16mm - ISO 2136
	75mm	x9	4, 5, 6, 7, 8, 10, 12, 14, 16mm - ISO 2136
	30mm	x10	T20, T25, T30, T40, T45, T50, T55, T60, T70, T80 - DIN 2325
	75mm	x10	T20, T25, T30, T40, T45, T50, T55, T60, T70, T80 - DIN 2325
	30mm	x7	M5, M6, M8, M10, M12, M14, M16 - DIN 2325
	75mm	x7	M5, M6, M8, M10, M12, M14, M16 - DIN 2325

# CAIXA FERRAMENTAS DE 42 PONTAS PARA PARAFUSOS TORX, UMBRAKO E 12 FACES

50983 48,00€

1,77 - 5 275



## CONTÉM

	<b>3/8"</b>	x1	10mm
	<b>1/2"</b>	x1	10mm
	30mm	x7	4, 5, 6, 7, 8, 10, 12mm
	75mm	x7	4, 5, 6, 7, 8, 10, 12mm
	30mm	x8	T20, T25, T30, T40, T45, T50, T55, T60
	75mm	x8	T20, T25, T30, T40, T45, T50, T55, T60
	30mm	x5	M5, M6, M8, M10, M12
	75mm	x5	M5, M6, M8, M10, M12



50985 59,00€

1,74 - 5 275



INVIOLÁVEL



## CONTÉM

	<b>3/8"</b>	x1	10mm
	<b>1/2"</b>	x1	10mm
	30mm	x7	4, 5, 6, 7, 8, 10, 12mm
	75mm	x7	4, 5, 6, 7, 8, 10, 12mm
	30mm	x8	T20, T25, T30, T40, T45, T50, T55, T60
	75mm	x8	T20, T25, T30, T40, T45, T50, T55, T60
	30mm	x5	M5, M6, M8, M10, M12
	75mm	x5	M5, M6, M8, M10, M12



# CAIXA DE FERRAMENTAS DE 75 CHAVES

52550 92,00€

3,61 - 4 96



S-2 3/8" 1/2" 75 PCS

## CONTÉM

	<b>3/8"</b>	x1	10mm
	<b>1/2"</b>	x2	10mm
	30mm	x7	4, 5, 6, 7, 8, 10, 12mm
	75mm	x7	4, 5, 6, 7, 8, 10, 12mm
	30mm	x8	T20, T25, T30, T40, T45, T50, T55, T60
	75mm	x8	T20, T25, T30, T40, T45, T50, T55, T60
	30mm	x5	M5, M6, M8, M10, M12
	75mm	x5	M5, M6, M8, M10, M12
	30mm	x8	M5, M6, M7, M8, M9, M10, M12, M14
	75mm	x5	M5, M6, M8, M10, M12
	30mm	x8	T20, T25, T30, T40, T45, T50, T55, T60
	75mm	x8	T20, T25, T30, T40, T45, T50, T55, T60



# KIT DE 208 BITS DE CHAVE DE FENDA

53574 47,00€

2,29	-	6	216
Kg	Sub	11	11

CrV 208 PCS



## CONTÉM

25mmL x12	1,5, 2, 2,5, 3, 3,5, 4, 4,5, 5, 5,5, 6, 7, 8mm	25mmL x4	4, 6, 8, 10mm
50mmL x10	1/16, 5/64, 3/32, 7/64, 1/8, 9/64, 5/32, 3/16, 7/32, 1/4	50mmL x4	4, 6, 8, 10mm
75mmL x5	2,5, 3, 4, 5, 6mm	25mmL x4	1, 2, 3, 4mm
50mmL x5	2,5, 3, 4, 5, 6mm	50mmL x4	1, 2, 3, 4mm
25mmL x18	PH00, PH0, PH1(x5), PH2(x5), PH3(x5), PH4	25mmL x6	2, 2,5, 3, 4, 5, 6mm
50mmL x3	PH1, PH2, PH3	25mmL x6	5/64, 3/32, 7/64, 1/8, 9/64, 5/32
75mmL x3	PH1, PH2, PH3	25mmL x13	T5, 6, 7, 8, 9, 10, 15, 20, 25, 27, 30, 40, 45
25mmL x17	PZ00, PZ0, PZ1(x5), PZ2(x5), PZ3(x4), PZ4	25mmL x3	1, 2, 3mm
50mmL x3	PZ1, PZ2, PZ3	25mmL x4	0, 1, 2, 3mm
75mmL x3	PZ1, PZ2, PZ3	25mmL x3	M5, M6, M8
25mmL x14	T5, T6, T7, T8, T9, T10, T15, T20, T25, T27, T30, T35, T40, T45	25mmL x9	TS10, TS15, TS20, TS25, TS27, TS30, TS40, TS45, TS50
50mmL x7	T10, T15, T20, T25, T27, T30, T40	25mmL x12	SL2, SL2.5, SL3, SL3.5, SL4, SL4.5, SL5, SL5.5, SL6, SL6.5, SL7, SL8
75mmL x7	T10, T15, T20, T25, T27, T30, T40		
25mmL x3	6, 8, 10mm		
50mmL x3	6, 8, 10mm		

mm	x10	4, 5, 6, 7, 8, 9, 10, 11, 12, 13
"	x10	5/32, 3/16, 7/32, 1/4, 9/32, 5/16, 11/32, 3/8, 7/16, 1/2
6mm	x1	1/4" Adaptador
	x1	

# SET DE PONTAS VARIADAS

52539 59,00€

1,90	-	5	128
Kg	Sub	11	11

ALLEN 8 CrV 85 PCS

## CONTÉM

8mm	x2	PH3, PH4
	x2	PZ3, PZ4
	x5	7, 8, 10, 12, 14mm
	x3	SL8, SL10, SL12
	x5	T40, T45, T50, T55, T60



# SET DE PONTAS VARIADAS

52538 62,00€

2,07	-	16	128
Kg	Sub	11	11

CrV 1/4" 90 PCS

## CONTÉM

1/4"	x2	PH1, PH2
	x2	PZ1, PZ2
	x5	3, 4, 5, 6mm
	x3	SL4, SL5.5, SL6.5
	x5	T8, T10, T15, T20, T25, T27, T30



# JOGO DE 6 ADAPTADORES

51333 18,00€

0,52	5	40	960
Kg	Sub	11	11

CrV 6 PCS

ZINCADO

M	H
1/2"	3/4"
3/8"	1/2"
1/4"	3/8"
3/8"	1/4"
1/2"	3/8"
3/4"	1/2"



## REPOSIÇÕES DISPONÍVEL

REF.	DESCRIÇÃO	Kg	€
11360	1/4H - 3/8M	0,02	2,60€
11361	1/4M - 3/8H	0,05	3,20€
11362	3/8H - 1/2M	0,13	5,20€
11363	1/4H - 3/8M	0,05	3,90€
11364	1/2H - 3/8M	0,05	4,50€
11365	3/4H - 1/2M	0,14	9,40€



# CONJUNTO DE 6 ADAPTADORES DE IMPACTO

53743 39,70€

0,80	5	20	960
Kg	Sub	11	11

CrMo 6 PCS



## REPOSIÇÕES DISPONÍVEL

REF.	mm	Kg	Sub	11	€
14749	1/4" F - 3/8" M	-	20	100	2,00€
14750	3/8" F - 1/4" M	-	20	100	2,00€
14751	3/8" F - 1/2" M	-	20	100	4,00€
14752	1/2" F - 3/8" M	-	10	100	4,00€

M	H
3/4"	1/2"
1/2"	3/4"
3/8"	1/4"
1/4"	3/8"
1/2"	3/8"
3/8"	1/2"



# CAIXA DE FERRAMENTAS DE 38 PEÇAS COM MINI ROQUETE DE 1/4"

**53156** 26,20€

0,48 6 36 1008  
Kg SUB ff



**52198** 37,70€

0,45 6 36 1800  
Kg SUB ff



CrV 1/4" 38 PCS

## CONTÉM

	1/4"	x11	4, 4.5, 5, 6, 7, 8, 9, 10, 11, 12, 13mm
	72	x1	1/4"
		x2	PH3, PH4
		x2	PZ3, PZ4
		x5	4, 5, 6, 7, 8mm
	6mm	x3	SL6, SL8, SL10
		x2	T8, T9, T10, T15, T20, T25, T30, T40
		x4	M5, M6, M9, M10
		x1	1/4"

## CONJUNTO DE CHAVES DE CAIXA 1/2" HEXAGONAIS

**52714** 15,70€

0,65 4 24 576  
Kg SUB ff



APRESENTADA EM GUÍA METÁLICA



REPOSIÇÕES DISPONÍVEIS

**52716** 15,90€

0,61 4 24 576  
Kg SUB ff



10, 11, 12, 13, 14, 15, 16, 17, 18, 19mm

1/2" 10 PCS

CrV



APRESENTADA EM GUÍA METÁLICA



REPOSIÇÕES DISPONÍVEIS

## CONJUNTO DE CHAVES DE CAIXA 1/4" HEXAGONAIS

**52715** 10,00€

0,35 6 36 1152  
Kg SUB ff



APRESENTADA EM GUÍA METÁLICA



REPOSIÇÕES DISPONÍVEIS

**52717** 11,00€

0,27 6 36 1152  
Kg SUB ff



4, 4.5, 5, 5.5, 6, 7, 8, 9, 10, 11, 12, 13, 14mm

1/4" 13 PCS

CrV



APRESENTADA EM GUÍA METÁLICA



REPOSIÇÕES DISPONÍVEIS

## JOGO DE 18 PONTAS DE 1/4"

**52909** 12,50€

0,35 8 32 1500  
Kg SUB ff

S-2 1/4" 18 PCS

CrV

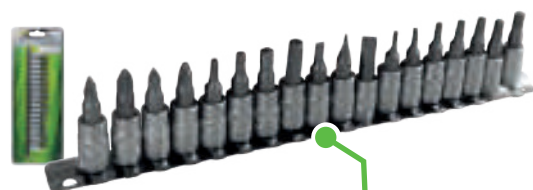

APRESENTADA EM GUÍA METÁLICA



REPOSIÇÕES DISPONÍVEIS

## JOGO DE 30 PONTAS DE 1/4"

**52908** 17,00€

0,60 8 32 500  
Kg SUB ff

S-2 1/4" 30 PCS

CrV



APRESENTADA EM GUÍA METÁLICA



REPOSIÇÕES DISPONÍVEIS

### CONTÉM

	x2	PH1, PH2
	x2	PZ1, PZ2
	x4	3, 4, 5, 6mm
	x3	SL4, SL5.5, SL6.5
	x7	T8, T10, T15, T20, T25, T27, T30

### CONTÉM

	x3	PH0, PH1, PH2
	x3	PZ0, PZ1, PZ2
	x4	3, 4, 5, 6mm
	x4	SL4, SL5.5, SL6.5, SL7
	x8	T8, T9, T10, T15, T20, T25, T27, T30
	x8	T8, T9, T10, T15, T20, T25, T27, T30

## JOGO DE PONTAS TORX 3/8" - 1/2"

53084 24,00€

0,60 5 20 880  
Kg SUB



1/2"

3/8"

7 PCS

CrV

3/8": T30, T40, T45, T50  
1/2": T55, T60, T70



REPOSIÇÕES DISPONÍVEIS

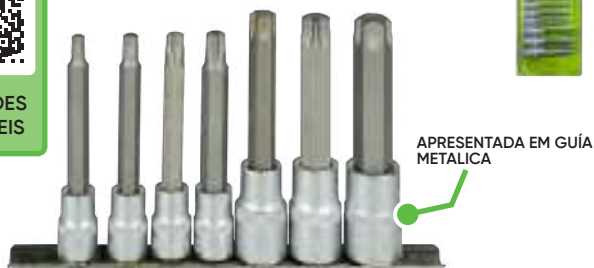

APRESENTADA EM GUÍA METÁLICA

## JOGO DE 7 PONTAS TORX INVOLÁVEL 1/4"

53127 12,00€

0,15 5 100 1800  
Kg SUB



CrV

1/4"

7 PCS

T10, T15, T20, T25, T30, T40, T45



REPOSIÇÕES DISPONÍVEIS



APRESENTADA EM GUÍA METÁLICA

## JOGO PONTAS TS 5 CARAS INVOLÁVEL

51746 12,00€

0,20 5 75 1050  
Kg SUB

TS10, TS15, TS20, TS25, TS30, TS40, TS45



CrV

1/4"

7 PCS

APRESENTADA EM GUÍA METÁLICA



## JOGO DE PONTAS DE RIBE

50980 22,00€

0,76 5 20 300  
Kg SUB



1/2" 1/2" 100mm: M12, M13, M14  
3/8" 3/8" 90mm: M6, M7, M8, M10

50982 22,00€

0,46 6 36 1080  
Kg SUB



3/8" 3/8" 100mm HB3: 4, 5, 6, 7, 8, 10mm

52320 22,00€

0,76 5 20 480  
Kg SUB



1/2" 1/2" 100mm: M12, M13, M14  
3/8" 3/8" 90mm: M6, M7, M8, M10



APRESENTADA EM GUÍA METÁLICA

## CHAVE PONTA XZN ESP. VAG

12029 5,50€

0,17 5 100 1500  
Kg SUB



INVOLÁVEL M16X58MM



12030 6,50€

0,25 8 80 -  
Kg SUB

INVOLÁVEL M16X100MM



## VARILHA EXTRA-LARGA DE 12 FACES DE 800mm de 1/2"

REF.	DESCRIÇÃO	Kg	SUB	ff	€
52059	Ø 8mm - 800mm	0,58	-	25	29,00€
52060	Ø 10mm - 800mm	0,58	-	25	32,00€
53667	Ø 12mm - 800mm	0,80	10	20	32,00€
53668	Ø 14mm - 800mm	1,05	10	20	34,00€

800mm



CrV

1/2"





# FERRAMENTA PARA ALTA VOLTAGEM

## MALETA DE FERRAMENTA ISOLADA - 26PEÇAS

54091 441,00€

4,20	-	3	72

### CONTÉM

	<b>3/8"</b>	x10	8, 10, 11, 12, 13, 14, 16, 17, 18, 19, 21, 22mm
	<b>3/8"</b>	x1	200mm
	<b>1/2"</b>	x1	125mm
	<b>3/8"</b>	x1	200mm
		x2	4x100mm, 5,5x125mm
		x2	PH1x80mm, PH2x100mm
		x1	185mm
		x1	
		x1	185mm
		x6	7x86mm, 8x99mm, 10x109mm, 12x127mm, 14x141mm, 17x156



## MÓDULO EVA DE FERRAMENTA ISOLADA

54093 441,00€

3,25	-	4	80

### CONTÉM

	<b>3/8"</b>	x10	8, 10, 11, 12, 13, 14, 16, 17, 18, 19, 21, 22mm
	<b>3/8"</b>	x1	200mm
	<b>1/2"</b>	x1	125mm
	<b>3/8"</b>	x1	200mm
		x2	4x100mm, 5,5x125mm
		x2	PH1x80mm, PH2x100mm
		x1	185mm
		x1	
		x1	185mm
		x6	7x86mm, 8x99mm, 10x109mm, 12x127mm, 14x141mm, 17x156



## MALETA DE FERRAMENTA ISOLADA 20 PEÇAS DE 3/8"

53154 462,00€

3,30	-	3	72

### CONTÉM

	<b>3/8"</b>	x12	8, 10, 11, 12, 13, 14, 16, 17, 18, 19, 21, 22mm
	<b>1/2"</b>	x1	200mm
	<b>1/2"</b>	x2	125, 250mm
	<b>3/8"</b>	x1	200mm
	<b>3/8"</b>	x4	4, 5, 6, 8mm

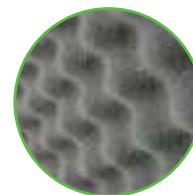

## CONJUNTO DE PONTAS E CHAVES ISOLADAS ATÉ 1000V

52009 36,00€

0,34	10	50	1200
Kg	Sub	11	11

- Optimizado para aplicações em trabalhos com electricidade.  
- Ferramenta de segurança.

CrV

6 PCS



### CONTÉM

	x2	PH1x100, PH2x100
	x4	SL0.4x2.5x100, SL0.8x4.0x100, SL1.0x5.5x100, SL1.2x6.5x100mm



Cumprir com: DIN EN60900:2005-01 - EN60900:2004

## CONJUNTO DE 50 CHAVES ISOLADAS ATÉ 1.000V

52521 125,00€

1,43	-	6	216
Kg	Sub	11	11

CrV

50 PCS



### CONTÉM

	x3	PH0, PH1, PH2		x1	89
	x7	SL0.4x2.0, SL0.4x2.5, SL0.5x3.0, SL0.6x3.5, SL0.8x4.0, SL1.0x5.5, SL1.2x6.5mm		x1	89
	x3	PZ0, PZ1, PZ2			Voltage Tester: 3.0 x 70 + Torx 31 x 105
	x9	T6, T8, T9, T10, T15, T20, T25, T27, T30		x5	H2.5, H3, H4, H5, H6
	x2	R1, R2		x3	M4x4.0, M5x5.0, M6x5.0
	x4	1, 2, 3, 4		x4	4, 6, 8, 10mm
	x4	4, 6, 8, 10		x2	R1, R2
				x2	6.3 x 89, 8.1 x 89



## CONJUNTO DE 7 CHAVES ISOLADAS ATÉ 1.000V

52519 25,50€

0,14	5	10	840
Kg	Sub	11	11

### CONTÉM

	x2	PH00x50, PH0x50mm
	x5	SL1.5x0.23x50, SL1.8x0.30x50, SL2.0x0.40x50, SL2.5x0.40x50, SL3.0x0.50x50mm

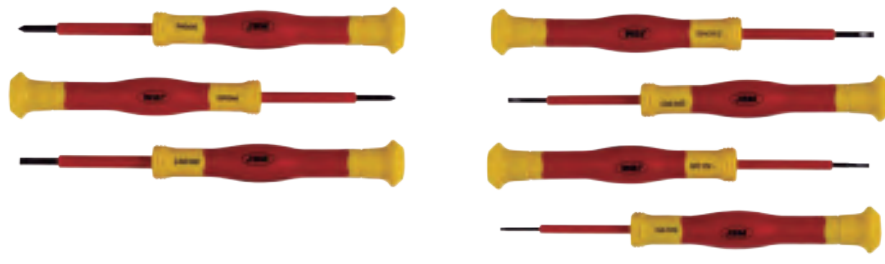

CrV

7 PCS



## CHAVE DE FENDA EVA - ACABAMENTO DE CARBONO

15162 30,20€

0,65	-	10	240
Kg	Sub	11	11

	x4	0.5x3.0x75, 0.8x4.0x100, 1.0x5.5x125, 1.2x6.5x150mm
	x3	PH0x75, PH1x80, PH2x100mm

8 PCS

### REPOSIÇÕES DISPONÍVEIS

REF.	Ø	Kg	Sub	11	€
15227	0.5x3.0x75mm	0,02	10	50	3,50€
15228	0.8x4.0x100mm	0,05	10	50	4,00€
15229	1.0x5.5x125mm	0,08	5	50	5,00€
15230	1.2x6.5x150mm	0,11	5	50	5,00€
15231	PH0x75mm	0,02	10	50	3,50€
15232	PH1x80mm	0,05	10	50	4,00€
15233	PH2x100mm	0,08	5	50	5,00€
15234	Tester Circuito Automotivo 140mm	0,02	10	50	3,00€

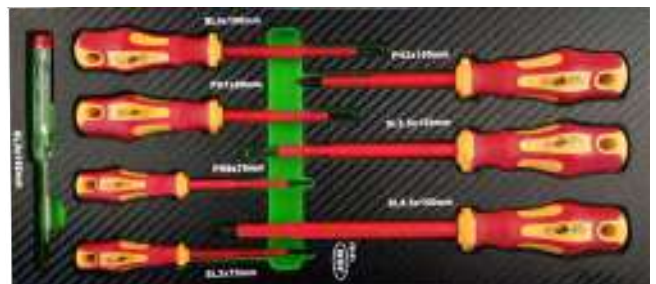

## NAVALHA CORTA CABOS

### RETA

53164 16,50€

0,10	6	36	1152
Kg	Sub	11	11



### CURVADA

53165 19,60€

0,10	6	36	1152
Kg	Sub	11	11



180mm

50mm

CrV







# FERRAMENTAS MANUAIS

- 34 CHAVES
- 41 FERRAMENTAS EM POLEGADAS
- 42 CHAVES DE FENDA
- 44 MEDIÇÃO
- 45 CADEADOS
- 46 MARTELOS
- 47 SERRAS
- 48 CINZEL
- 49 REBITADORES
- 50 CATRACAS - ROQUETES
- 54 BARRAS DE EXTENSÃO
- 55 FERRAMENTAS DE INSPEÇÃO
- 57 CORTADOR DE TUBOS
- 57 DESCAPADOR DE FIO
- 57 ALICATES
- 63 CHAVES DE GANCHO /  
QUEBRAS PORCAS  
/ CHAVE INGLESA
- 64 CHAVES STILLSON / SARGENTOS

# JOGO DE 6 CHAVES COMBINADAS COM ROQUETE

54101

61,00€

8x9, 10x11, 12x13, 14x15, 16x18, 17x19mm



6 PCS

0,90	-	10	750
Kg	SUB	11	11



## REPOSIÇÕES DISPONÍVEL

REF.	mm	Kg	SUB	€	REF.	mm	Kg	SUB	€
15632	8x9	0,15	10	9,35€	15635	14x15	0,22	10	11,00€
15633	10x11	0,16	10	9,50€	15636	16x18	0,26	5	12,30€
15634	12x13	0,19	10	10,60€	15637	17x19	0,28	10	12,50€



54117

74,00€

8,9,10,11,12,13,14,15,16,17,18, 19mm



12 PCS

1,80	5	10	240
Kg	SUB	11	11



## REPOSIÇÕES DISPONÍVEL

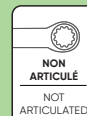

51318

98,00€

8, 9, 10, 11, 12, 13, 14, 15, 16, 17, 18, 19mm



12 PCS

2,15	5	10	240
Kg	SUB	11	11

CROMADO



## REPOSIÇÕES DISPONÍVEL



REF.	mm	Kg	SUB	€
10552	8mm	0,06	10	7,10€
10553	9mm	0,07	10	7,35€
10554	10mm	0,09	10	7,50€

REF.	mm	Kg	SUB	€
10555	11mm	0,09	10	7,80€
10556	12mm	0,11	10	8,10€
10557	13mm	0,13	10	8,10€

53017

57,00€

8, 10, 11, 13, 14, 17, 19mm



7 PCS

1,30	5	10	330
Kg	SUB	11	11

CROMADO



REF.	mm	Kg	SUB	€
10558	14mm	0,15	10	9,35€
10559	15mm	0,16	10	9,50€
10560	16mm	0,19	10	10,60€

REF.	mm	Kg	SUB	€
10561	17mm	0,22	10	11,00€
10562	18mm	0,26	5	12,30€
10563	19mm	0,28	10	12,50€

# JOGO DE 7 CHAVES COM ROQUETE EXTRA LONGO

54066

83,00€

2,00	5	175
Kg	SUB	11

MÓDULO COM ACABAMENTO EM FIBRA DE CARBONO

CROMADO



7 PCS

## REPOSIÇÕES DISPONÍVEL



REF.	mm	Kg	SUB	€
13453	8mm	0,1	6	9,00€
13454	10mm	0,15	6	9,50€
13455	12mm	0,21	6	10,50€
13456	13mm	0,20	6	11,50€
13457	14mm	0,25	6	12,00€
13460	17mm	0,4	6	15,00€
13462	19mm	0,5	6	17,00€

8mm (23,5mmL)
10mm (29,3mmL)
12mm (32,8mmL)
13mm (34,9mmL)
14mm (36,7mmL)
17mm (41mmL)
19mm (42mmL)



## CONJUNTO DE 22 CHAVES COMBINADAS COM ROQUETE

**54041** 198,00€

900	-	2	42
Kg	Sub	11	11

6, 7, 8, 9, 10, 11, 12, 13, 14, 15, 16, 17, 18, 19, 20, 21, 22, 23, 24, 27, 30, 32mm

90°



22 PCS

REPOSIÇÕES DISPONÍVEI



REF.54041, 54117, 15122, 53871  
REPOSIÇÕES DISPONÍVEI

## MÓDULO DE CARBONO EVA DE 12 CHAVES COMBINADAS COM ROQUETE

**15122** 74,00€

1,70	-	10	200
Kg	Sub	11	11

8, 9, 10, 11, 12, 13, 14, 15, 16, 17, 18, 19mm

72°



12 PCS

CROMADO

REPOSIÇÕES DISPONÍVEI



## CONJUNTO DE 12 CHAVES COMBINADAS COM ROQUETE

**53871** 60,00€

1,60	2	6	288
Kg	Sub	11	11

REPOSIÇÕES DISPONÍVEI



8, 9, 10, 11, 12, 13, 14, 15, 16, 17, 18, 19mm

72°



12 PCS

CROMADO



## CONJUNTO DE 12 MINI CHAVES COMBINADAS ARTICULADAS COM ROQUETE

**54032** 84,00€

1,45	-	10	240
Kg	Sub	11	11

8, 9, 10, 11, 12, 13, 14, 15, 16, 17, 18, 19mm

90°



12 PCS



REF.	mm	Kg	Sub	€	REF.	mm	Kg	Sub	€
15328	8mm	0,05	12	6,00€	15334	14mm	0,11	12	7,00€
15329	9mm	0,17	12	5,50€	15335	15mm	0,17	12	7,50€
15330	10mm	0,22	12	5,50€	15336	16mm	0,22	12	8,00€
15331	11mm	0,31	12	5,50€	15337	17mm	0,31	12	8,50€
15332	12mm	0,45	12	6,00€	15338	18mm	0,45	12	9,00€
15333	13mm	0,47	12	6,50€	15339	19mm	0,47	12	9,50€

## CONJUNTO DE 8 MINI CHAVES COMBINADAS COM ROQUETE

**54110** 46,00€

0,90	-	10	840
Kg	Sub	11	11

10, 11, 12, 13, 14, 15, 17, 19mm

72°



8 PCS

REPOSIÇÕES DISPONÍVEI

REF.	mm	Kg	Sub	€
13491	10mm	0,5	10	5,30€
13492	11mm	0,6	10	5,35€
13493	12mm	0,7	10	5,50€
13494	13mm	0,8	10	6,00€
13495	14mm	0,9	10	6,40€
13496	15mm	1,2	10	6,60€
13497	17mm	1,4	10	7,50€
13498	19mm	1,9	10	8,50€



## JOGO DE 6 CHAVES ARTICULADAS COM ROQUETE

53018 119,00€

2,66 - 5 125



CROMADO



8x9,10x11, 12x13, 14x15, 16x18, 17x19mm



6 PCS

### REPOSIÇÕES DISPONÍVEI

REF.	mm	Kg	Sub	€
13447	8x9mm	0,1	6	16,50€
13448	10x11mm	0,15	6	17,50€
13449	12x13mm	0,25	6	20,00€
13450	14x15mm	0,3	6	23,00€
13451	16x18mm	0,35	6	28,00€
13452	17x19mm	0,4	6	29,50€

## JOGO DE 4 CHAVES TORX COM ROQUETE ARTICULADAS

50754 98,00€

0,82 - 20 360



CROMADO

- Cabeça Articulada de 0° a 180°.
- Roquete de 72 dentes com 5° de Arco.



E6 x E8  
E10 x E12  
E14 x E18  
E20 x E24



4 PCS

### REPOSIÇÕES DISPONÍVEI

REF.	mm	Kg	Sub	€
10527	E6x8	0,1	10	13,10€
10528	E10x12	0,15	10	15,80€
10529	E14x18	0,25	10	18,00€
10530	E20x24	0,35	10	28,70€

## KIT DE 3 CHAVES TIPO 4 EM 1

15316 58,00€

0,85 - 10 260



CROMADO



8-9-10-11-12-13-14-15-16-17-18-19mm



3 PCS

### REPOSIÇÕES DISPONÍVEI

REF.	mm	Kg	€
15515	12-13mm x 8-10mm	0,13	15,50€
15516	14-15mm x 9-11mm	0,18	19,00€
15517	18-19mm x 16-17mm	0,37	22,50€

## CAIXA FERRAMENTAS DE 6 CHAVES 12 FACES ARTICULADAS

51659 59,00€

1,60 - 10 240



CROMADO



8x9, 10x11, 12x13, 14x15, 16x17, 18x19mm



6 PCS

### REPOSIÇÕES DISPONÍVEI

REF.	Ø	Kg	Sub	€
10621	XZN 8-9	0,09	-	9,50€
10622	XZN 10-11	0,13	-	10,00€
10623	XZN 12-13	0,16	5	12,60€
10624	XZN 14-15	0,20	-	13,50€
10625	XZN 16-17	0,29	-	15,70€
10626	XZN 18-19	0,37	-	17,80€

## CAIXA DE FERRAMENTAS 4 CHAVES ARTICULADAS TORX

50622 64,00€

1,05 - 10 320



CROMADO



E6x8, E10x12, E14x18, E20x24



4 PCS

### REPOSIÇÕES DISPONÍVEI

REF.	Ø	Kg	€
10617	E6x8	0,07	14,10€
10618	E10x12	0,11	15,10€
10619	E14x18	0,20	15,70€
10620	E20x24	0,34	16,20€



## CONJUNTO DE 21 CHAVES COMBINADAS

**54079** 83,00€

4,00 - 8 160  
Kg SUB if

**21 PCS**

6mm, 7mm, 8mm, 9mm, 10mm, 11mm, 12mm, 13mm, 14mm, 15mm, 16mm, 17mm, 18mm, 19mm, 20mm, 21mm, 22mm, 24mm, 27mm, 30mm, 32mm

## CONJUNTO DE 14 CHAVES COMBINADAS

**50560** 38,60€

1,25 5 20 240  
Kg SUB if

ZINCADO

**CrV** 6, 7, 8, 9, 10, 11, 12, 13, 14, 15, 16, 17, 18, 19mm

**54097** 38,90€

1,40 - 10 570  
Kg SUB if

**CrV** 14 PCS 6, 7, 8, 9, 10, 11, 12, 13, 14, 15, 16, 17, 18, 19mm

### REPOSIÇÕES DISPONÍVEI

ZINCADO	mm	Kg	Sub	If	€
10548	6mm	0,03	10	100	1,75€
10549	7mm	0,03	10	100	2,00€
10550	8mm	0,04	10	100	2,15€
10551	9mm	0,04	10	100	2,15€
10531	10mm	0,05	10	100	3,00€

ZINCADO	mm	Kg	Sub	If	€
10532	11mm	0,05	10	100	2,70€
10533	12mm	0,07	10	100	3,00€
10534	13mm	0,08	10	100	3,25€
10535	14mm	0,06	10	100	3,50€
10536	15mm	0,10	10	100	3,65€

ZINCADO	mm	Kg	Sub	If	€
10537	16mm	0,11	10	100	3,90€
10538	17mm	0,14	10	100	4,30€
10539	18mm	0,16	10	100	4,75€
10540	19mm	0,20	10	60	5,25€

## JOGO DE 7 CHAVES COMBINADAS

**54120** 59,00€

2,89 - 6 252  
Kg SUB if

**CrV** 20, 21, 22, 24, 27, 30, 32mm

**7 PCS**

REPOSIÇÕES DISPONÍVEI

ZINCADO	mm	Kg	If	€
10541	20mm	0,21	60	5,55€
10542	21mm	0,25	50	5,85€
10543	22mm	0,25	50	7,00€
10544	24mm	0,33	50	8,10€
10545	27mm	0,41	50	9,75€
10546	30mm	0,52	25	11,60€
10547	32mm	0,59	25	13,50€

## JOGO DE 6 CHAVES COMBINADAS

**54174** 139,00€

8,70 - 2 750  
Kg SUB if

**XL** **CrV** 34,36,38, 41,46,50mm

**6 PCS**

REPOSIÇÕES DISPONÍVEI

ZINCADO	mm	Kg	If	€
16020	34mm	0,21	-	17,00€
16021	36mm	0,25	-	19,50€
16022	38mm	0,41	-	23,00€
16023	41mm	-	-	26,50€
16024	46mm	-	-	34,50€
16025	50mm	-	-	37,50€

## JOGO DE 10 CHAVES PÉ DE GALO 3/8"

**54187** 39,30€

0,55 5 20 1800  
Kg SUB if

**CrV** 10, 11, 13, 14, 15, 16, 17, 18, 19, 22mm

**3/8"**

# JOGO DE 8 CHAVES COMBINADAS CURTAS

**50564** 30,00€

0,60	5	20	600
Kg	sub	ff	



**8**  
PCS

10, 11, 12,  
13, 14, 15, 17,  
19mm



**CROMADO**



**REPOSIÇÕES DISPONÍVEL**

REF.	mm	Kg	sub	ff	€
10564	10	0,05	10	100	2,50€
10565	11	0,05	10	100	3,50€
10566	12	0,05	10	100	3,50€
10567	13	0,05	10	100	3,50€
10568	14	0,05	10	100	4,00€
10569	15	0,05	10	100	4,50€
10570	17	0,10	10	100	4,50€
10571	19	0,15	10	100	5,00€

# JOGO DE CHAVES MISTAS

12 CHAVES

6x7, 8x9, 10x11, 12x13, 14x15, 16x17, 18x19,  
20x22, 21x23, 24x27, 25x28, 30x32mm



**12**  
PCS

**ZINCADO**

**51529** 59,00€

2,63	-	5	200
Kg	sub	ff	

**CROMADO**

**52973** 59,00€

2,50	-	5	160
Kg	sub	ff	

**REPOSIÇÕES DISPONÍVEL**

REF.	mm	Kg	sub	ff	€
10589	6x7	0,03	10	100	2,00€
10590	8x9	0,04	10	100	2,40€
10579	10x11	0,06	10	100	3,00€
10580	12x13	0,07	10	100	3,10€
10581	14x15	0,10	10	100	3,40€
10582	16x17	0,14	10	100	4,00€
10583	18x19	0,19	10	100	4,15€
10584	20x22	0,25	60	100	5,05€
10585	21x23	0,31	-	50	6,75€
10586	24x27	0,35	-	50	7,60€
10587	25x28	0,36	-	50	9,80€
10588	30x32	0,54	-	25	10,50€



12 CHAVES

**54149** 60,00€

2,75	-	6	240
Kg	sub	ff	

6x7, 8x9, 10x11, 12x13, 14x15, 16x17, 18x19,  
20x22, 21x23, 24x27, 25x28, 30x32mm

**12**  
PCS



**ZINCADO**

**50561** 19,20€

0,69	5	20	400
Kg	sub	ff	

7 CHAVES

6x7, 8x9, 10x11, 12x13, 14x15,  
16x17, 18x19mm



**7**  
PCS

**REPOSIÇÕES DISPONÍVEL**

REF.	mm	Kg	sub	ff	€
10589	6x7	0,03	10	100	2,00€
10590	8x9	0,04	10	100	2,40€
10579	10x11	0,06	10	100	3,00€
10580	12x13	0,07	10	100	3,10€
10581	14x15	0,10	10	100	3,40€
10582	16x17	0,14	10	100	4,00€
10583	18x19	0,19	10	100	4,15€



7 CHAVES

**54150** 23,50€

0,75	10	20	720
Kg	sub	ff	

6x7, 8x9, 10x11, 12x13, 14x15,  
16x17, 18x19mm

**7**  
PCS



**REPOSIÇÕES DISPONÍVEL**

ZINCADO	mm	Kg	sub	ff	€	ZINCADO	mm	Kg	sub	ff	€	ZINCADO	mm	Kg	sub	ff	€	ZINCADO	mm	Kg	sub	ff	€
10589	6x7	0,03	10	100	2,00€	10580	12x13	0,07	10	100	3,10€	10583	18x19	0,19	10	100	4,15€	10586	24x27	0,35	-	50	7,60€
10590	8x9	0,03	10	100	2,40€	10581	14x15	0,10	10	100	3,40€	10584	20x22	0,25	-	100	5,05€	10587	25x28	0,36	-	50	9,80€
10579	10x11	0,06	5	100	3,00€	10582	16x17	0,14	10	100	4,00€	10585	21x23	0,31	-	50	6,75€	10588	30x32	0,54	-	25	10,50€



# JOGO DE 8 CHAVES TIPO "C" CABEÇAL REDONDO 12 FACES

**52451** 42,00€

0,93	5	20	480
Kg	sub	ff	ff

CROMADO

REPOSIÇÕES DISPONÍVEI



**54159** 47,00€

1,05	-	10	460
Kg	sub	ff	ff

6x7, 8x9, 10x11, 12x13, 14x15, 16x17, 18x19, 20x22mm



## JOGO DE 4 CHAVES TORX FIXAS

**54115** 26,80€

0,35	-	10	50
Kg	sub	ff	ff

E6xE8, E10xE12, E14xE18, E20xE24

4 PCS

CROMADO



## JOGO CHAVES FIXAS COM BOCA ABERTA DE 6 FACES

**54081** 28,00€

0,75	-	10	750
Kg	sub	ff	ff

10 x 11 HEX, 12 x 13 HEX, 14 x 15 HEX, 16 x 17 HEX, 18 x 19 HEX

5 PCS



## JOGO DE CHAVES FIXAS CURVADAS

12 CHAVES

CROMADO

**54119** 78,00€

3,20	-	6	168
Kg	sub	ff	ff

6x7, 8x9, 10x11, 12x13, 14x15, 16x17, 18x19, 20x22, 21x23, 24x27, 25x28, 30x32mm



12 PCS



REPOSIÇÕES DISPONÍVEI

7 CHAVES

ZINCADO

**50562** 23,50€

0,87	5	20	560
Kg	sub	ff	ff

6x7, 8x9, 10x11, 12x13, 14x15, 16x17, 18x19mm



7 PCS



50562



ZINCADO	mm	Kg	sub	ff	ff	€
10627	6x7	0,04	10	100	2,80€	
10628	8x9	0,06	10	100	3,10€	
10629	10x11	0,08	10	100	3,65€	

ZINCADO	mm	Kg	sub	ff	ff	€
10630	12x13	0,11	10	100	3,90€	
10631	14x15	0,14	10	100	4,20€	
10632	16x17	0,18	10	100	5,30€	

ZINCADO	mm	Kg	sub	ff	ff	€
10633	18x19	0,22	10	100	6,60€	
10634	20x22	0,43	-	50	7,80€	
10635	21x23	0,30	-	50	8,15€	

ZINCADO	mm	Kg	sub	ff	ff	€
10636	24x27	0,35	-	25	8,80€	
10637	25x28	0,48	6	24	12,10€	
10638	30x32	0,73	6	25	12,70€	

## 4 PÇS. CHAVE DUPLA FACE DE EXTREMIDADE FECHADA BANDEJA DE EVA REVESTIDA DE CARBONO

**15156** 70,00€

2,05	-	10	180
Kg	sub	ff	ff

CROMADO

REPOSIÇÕES DISPONÍVEI

REF.	mm	Kg	sub	ff	ff	€
15206	21x23	0,45	5	50	15,00€	
15207	24x27	0,5	5	50	16,50€	
15208	25x28	0,45	5	50	17,00€	
15209	30x32	0,67	10	50	18,00€	



4 PCS

21x23, 24x27, 25x28, 30x32mm



IVA não incluído

# JOGOS 6 CHAVES EXTRA-LARGAS

**51864** 64,00€

1,87	-	10	210
Kg	sub	ff	ff

10x11mm (290mmL),  
12x14mm (330mmL),  
13x15mm (368mmL),  
16x18mm (407mmL),  
17x19mm (407mmL),  
22x24mm (430mmL)

**REPOSIÇÕES DISPONÍVEI**

REF.	Ø	Kg	sub	ff	ff	€
11244	XL XZN 10x11	0,13	5	-	-	8,50€
11245	XL XZN 12x14	0,18	-	-	-	9,15€
11246	XL XZN 13x15	0,25	6	-	-	12,40€
11247	XL XZN 16x18	0,30	6	-	-	14,00€
11248	XL XZN 17x19	0,31	6	-	-	14,60€
11249	XL XZN 22x24	0,43	6	-	-	26,50€



**6 PCS**



**52912** 91,00€

1,62	-	10	210
Kg	sub	ff	ff

E6xE7 (200mmL),  
E8xE10 (235mmL),  
E11xE12 (290mmL),  
E14xE16 (370mmL),  
E18xE20 (410mmL),  
E22xE24 (420mmL)

**CROMADO**



**6 PCS**



## 14 CHAVES DE DUAS BOCA EM FORMA DE "L"

**51528** 49,00€

3,55	-	5	270
Kg	sub	ff	ff

**ZINCADO**

REFmm	Kg	€
10603	8 0,07	2,10€
10604	9 0,08	2,25€
10591	10 0,09	2,50€
10592	11 0,12	2,55€
10593	12 0,16	3,15€
10594	13 0,17	3,20€
10595	14 0,20	3,35€
10596	15 0,25	4,25€
10597	16 0,30	4,50€

**REPOSIÇÕES DISPONÍVEI**



REF.	mm	Kg	€
10598	17 0,32	4,60€	
10599	18 0,43	6,00€	
10600	19 0,41	6,25€	
10601	20 0,45	6,50€	
10602	21 0,47	7,05€	



8, 9, 10, 11, 12, 13, 14, 15,  
16, 17, 18, 19, 20, 21mm



**14 PCS**

## KIT DE 8 CHAVES DE TUBO

**53420** 72,00€

1,50	-	20	540
Kg	sub	ff	ff

**ZINCADO**



6x7, 8x9, 10x11, 12x13, 14x15,  
16x17, 18x19, 20x22mm



**8 PCS**

## JOGO DE 8 CHAVES EN "T" CABEÇA PLANA

**53979** 34,60€

1,00	-	10	180
Kg	sub	ff	ff

T10x75,  
T15x75,  
T20x100,  
T25x100,  
T30x150,  
T40x150,  
T45x200,  
T50x200mm



## JOGO DE 8 CHAVES EN "T" CABEÇA REDONDA

**53980** 34,60€

1,00	-	10	180
Kg	sub	ff	ff

H2x100,  
H2.5x100,  
H3x100,  
H4x150,  
H5x150,  
H6x200,  
H8x200,  
H10x200





# CONJUNTO DE 9 BOCAIS



EXTRA LONGOS

**53737** 12,50€

0,42	10	40	1000
Kg	SUB	ff	



90-218mm

LONGOS

**53739** 10,50€

0,32	10	40	1440
Kg	SUB	ff	



86-150mm

CURTOS

**53955** 10,00€

0,25	10	40	1480
Kg	SUB	ff	



72-170mm

T10, T15, T20, T25, T27, T30, T40, T45, T50

53737/53739/53955



EXTRA LONGOS

**53738** 10,90€

0,45	10	40	1000
Kg	SUB	ff	



90-220mm

LONGOS

**53740** 9,10€

0,37	10	40	1200
Kg	SUB	ff	

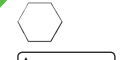

72-170mm

CURTOS

**53954** 8,50€

0,25	10	40	1480
Kg	SUB	ff	

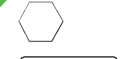

43-97mm

1,5, 2, 2,5, 3, 4, 5, 6, 8, 10mm

53738/53740/53954

## FERRAMENTAS EM POLEGADA

JOGO DE 17 CHAVES COMBINADAS EM POLEGADA

**51890** 92,00€

ZINCADO

17 PCS

4,45	-	4	168
Kg	SUB	ff	



JOGO DE 9 CHAVES UMBRAKO EM POLEGADA

**54005** 14,00€

72-170mm

9 PCS

CrV

0,35	10	40	1200
Kg	SUB	ff	

1/16", 5/64", 3/32", 1/8", 5/32", 3/16", 1/4", 5/16", 3/8"



CAIXA DE FERRAMENTAS DE 37 PEÇAS EM POLEGADA

**54106** 89,00€

4,70	-	3	108
Kg	SUB	ff	

CrV 1/2" 1/4" 37 PCS

CONTÉM

	1/2"	x17	5/16", 3/8", 7/16", 1/2", 9/16", 19/32", 5/8", 11/16", 3/4", 13/16", 7/8", 15/16", 1", 1-1/16", 1-1/8", 1-3/16", 1-1/4"
	1/4"	x8	3/16", 7/32", 1/4", 9/32", 5/16", 11/32", 3/8", 7/16"
	53076	x2	1/2" - 1/4"
	1/2"	x2	5", 10"
	1/4"	x1	3"
		x1	1/2"



	x1	1/4"
	x2	1/2" - 1/4"
	x1	1/4"

## KIT DE 208 BITS

53574 47,00€

2,29 - 6 216



208  
PCS

CrV

### CONTÉM

25mmL	x12	1,5, 2, 2,5, 3, 3,5, 4, 4,5, 5, 5,5, 6, 7, 8mm	25mmL	x4	4, 6, 8, 10mm
x10		1/16, 5/64, 3/32, 7/64, 1/8, 9/64, 5/32, 3/16, 7/32, 1/4	50mmL	x4	4, 6, 8, 10mm
50mmL	x5	2,5, 3, 4, 5, 6mm	25mmL	x4	1, 2, 3, 4mm
75mmL	x5	2,5, 3, 4, 5, 6mm	50mmL	x4	1, 2, 3, 4mm
25mmL	x18	PH00, PH0, PH1(x5), PH2(x5), PH3(x5), PH4	25mmL	x6	2, 2,5, 3, 4, 5, 6mm
50mmL	x3	PH1, PH2, PH3	25mmL	x6	5/64, 3/32, 7/64, 1/8, 9/64, 5/32
75mmL	x3	PH1, PH2, PH3	25mmL	x13	T5, 6, 7, 8, 9, 10, 15, 20, 25, 27, 30, 40, 45
25mmL	x17	PZ00, PZ0, PZ1(x5), PZ2(x5), PZ3(x4), PZ4	25mmL	x3	1, 2, 3mm
50mmL	x3	PZ1, PZ2, PZ3	25mmL	x4	0, 1, 2, 3mm
75mmL	x3	PZ1, PZ2, PZ3	25mmL	x3	M5, M6, M8
25mmL	x14	T5, T6, T7, T8, T9, T10, T15, T20, T25, T27, T30, T35, T40, T45	25mmL	x9	TS10, TS15, TS20, TS25, TS27, TS30, TS40, TS45, TS50
50mmL	x7	T10, T15, T20, T25, T27, T30, T40	25mmL	x12	SL2, SL2.5, SL3, SL3.5, SL4, SL4.5, SL5, SL5.5, SL6, SL6.5, SL7, SL8
75mmL	x7	T10, T15, T20, T25, T27, T30, T40			
25mmL	x3	6, 8, 10mm			
50mmL	x3	6, 8, 10mm			

mm	x10	4, 5, 6, 7, 8, 9, 10, 11, 12, 13
"	x10	5/32, 3/16, 7/32, 1/4, 9/32, 5/16, 3/8, 7/16, 1/2
6mm	x1	1/4"
	x1	Adaptador

## JOGO DE CHAVES - CURTAS E LONGAS

52500 19,00€

0,33 - 60 720



### CURTAS

PH00	x3	SL0,4x2x25
PH0x25		SL0,4x2,5x25
PH1x25		SL0,5x3x25
		SL0,5x3,5x25
		SL0,8x4x25

53917 9,00€

0,20 5 50 950



### LONGAS

PH00, PH0, PH1	x3	SL1,4, SL2,0, SL2,4, SL3,0
----------------	----	----------------------------

## ESTOJO DE DESTORNILLADORES COM CABO INTERCAMBIÁVEL 20 EM 1

53010 18,00€

0,72 5 20 480



PUNHO ERGONÓMICO

### CONTÉM

PH1, PH2	x2	
4x6, 5x7mm	x2	
T10x15, T20x25, T30x40	x3	
H4x4mm, cabeça redonda	x3	
H5x5mm, cabeça redonda		
H6x6mm, cabeça redonda		

## JOGO DE 4 CHAVES DE FENDA DE IMPACTO

50902 13,00€

0,70 6 42 648



3", 4", 6", 8"



4  
PCS

## CHAVE COM MULTIFUNÇÃO ESTRELA E FENDA

54060 6,00€

0,15 10 60 1500



54061 6,00€

0,10 10 60 1800



## CHAVE DE IMPACTO DE 1/2"

53694 18,40€

1,00 6 24 936

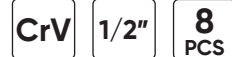

### CONTÉM

1/2"	x1	PH 2x36mm, 3x36mm, 3x70mm
1/2"	x1	SL 7x36mm, 8x36mm, 8x70mm





## CONJUNTO DE 6 CHAVES DE FENDA GO-THROUGH

**54071** 26,50€

1.10 - 10 270  
Kg SUB 11



SL8x150mm  
SL6.5x100mm  
SL5.5x75mm  
PH3x150mm  
PH2x100mm  
PH1x75mm

X3 X3

## CONJUNTO DE 6 CHAVES DE FENDA

**54070** 18,00€

0.50 - 10 360  
Kg SUB 11

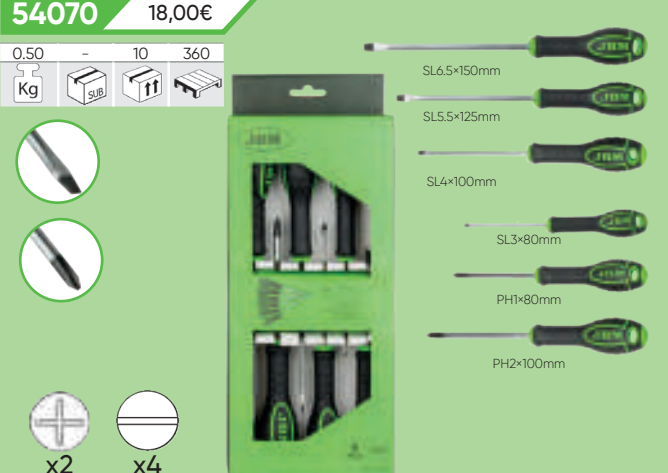

SL6.5x150mm  
SL5.5x125mm  
SL4x100mm  
SL3x80mm  
PH1x80mm  
PH2x100mm

x2 x4

## JOGO DE 12 CHAVES DE FENDA DE IMPACTO

**54126** 39,00€

2.75 - 4 108  
Kg SUB 11



12 PCS

x6 PH0x75mm  
PH1x75mm  
PH2x38mm  
PH2x100mm  
PH3x125mm  
PH4x150mm

x6 SL3,2x75mm  
SL5x75mm  
SL6x38mm  
SL6x100mm  
SL8x150mm  
SL9,5x200mm

## CHAVE DE FENDA EVA - ACABAMENTO DE CARBONO

**53943** 21,50€

0.80 - 10 240  
Kg SUB 11

x7 PH4x200, PH3x150, PH2x100, PH2x38, PH1x80, PH0x120, PH1x100

**53944** 19,50€

0.80 - 10 240  
Kg SUB 11

x7 SL9x200, SL4x125, SL5x100, SL5x80, SL6x38, SL6x100, SL8x150mm

**53945** 18,90€

0.60 - 10 240  
Kg SUB 11

x7 T8x75, T9x75, T10x75, T15x75, T20x75, T25x100, T27x100

180mm 380mm 30mm



## CHAVE FLEXÍVEL

**52170** 16,00€

0.27 12 48 672  
Kg SUB 11

1/4" 7 PCS

4, 5, 6, 7, 8, 10mm



## CHAVE FLEXÍVEL

**53575** 16,00€

0.40 10 40 480  
Kg SUB 11

CrV 1/4" 4 PCS

500mm

4, 5, 7mm

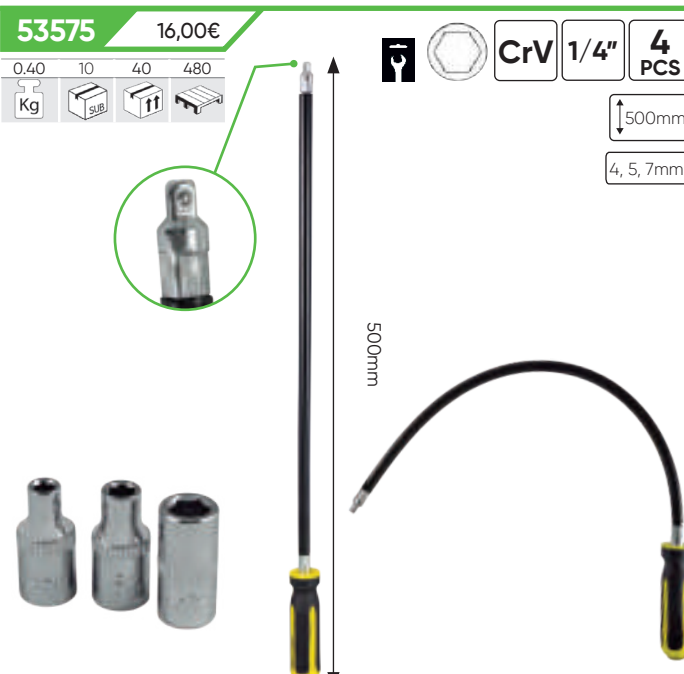

## JOGO DE 3 CHAVES FLEXÍVEIS

**52169** 25,00€

0.45 12 48 672  
Kg SUB 11

3 PCS

6, 7, 8mm



IVA não incluído

**JBM** / [www.jbmcamp.com](http://www.jbmcamp.com)

**53613** 19,50€

0,55 5 30 1260  
Kg SUB

500mm

**53614** 21,50€

0,60 5 30 840  
Kg SUB

600mm

**53615** 34,60€

0,85 5 20 600  
Kg SUB

800mm

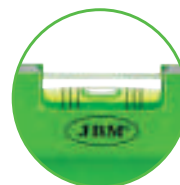

TUBULAR MAGNETIZADO

**53616** 10,40€

0,30 5 60 1260  
Kg SUB

500mm

**53617** 9,25€

0,30 5 60 840  
Kg SUB

600mm

**53618** 13,90€

0,35 5 30 600  
Kg SUB

800mm

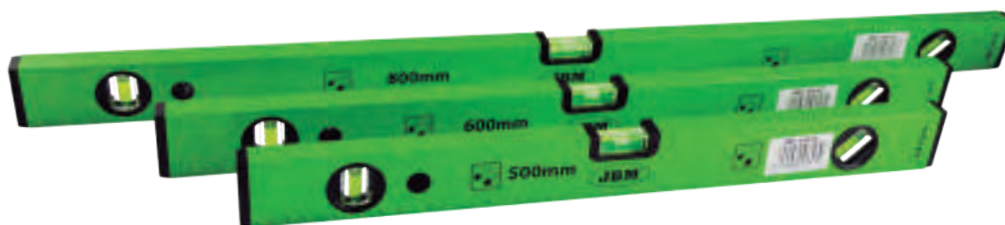

EXPOSITOR PARA NIVELES

**14183** 0,80 10  
31,00€ Kg



CINTA MÉTRICA

**53027** 9,00€

0,40 12 48 1500  
Kg SUB

7,5M x25mm

**53026** 5,80€

0,26 12 48 2016  
Kg SUB

5M x25mm

**53025** 3,50€

0,13 12 48 2016  
Kg SUB

3M x16mm



X-ACTO PROFESSIONAL

**51909** 2,46€

0,07 24 192 2304  
Kg SUB

10cm

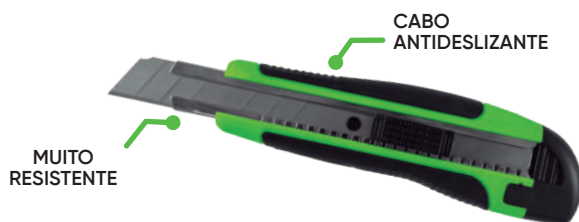

EM EXPOSITOR DE 24 UDS



## CADEADOS

**53405** 5,30€

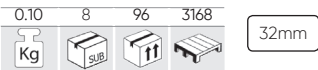

LONGO

**53403** 6,50€

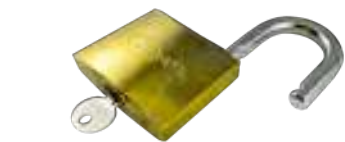
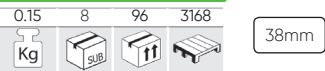

x3

**53404** 6,50€

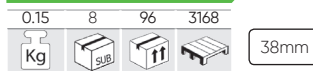

**53406** 8,55€

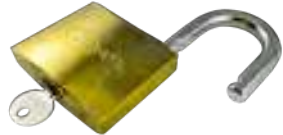
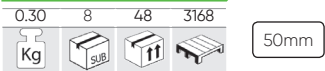

**53409** 9,00€



**53407** 12,70€

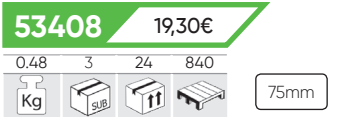
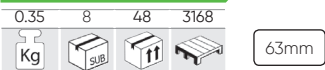

**53408** 19,30€

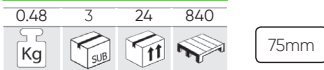

## CADEADOS RESISTENTES À ÁGUA

**53399** 3,50€

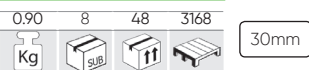

x2



**53400** 5,70€

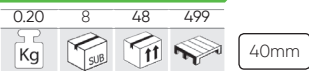

**53401** 7,40€

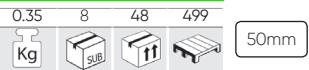

**53402** 9,60€

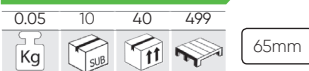

COM COBERTA DE PROTEÇÃO

**PEÇAS FERRAMENTAS MANUAIS 2023**

www.jbmcamp.com

Baixe aqui o nosso catálogo de peças soltas 2023!

www.jbmcamp.com

## MARTELO PROFSSIONAL CON PUNHO DE FIBRA

**52182** 24,00€

**2 Kg**

2.20 6 12 504



297mm

**52184** 43,00€

**4 Kg**

4.31 - 4 128



880mm

**52185** 55,00€

**6 Kg**

6.97 - 4 72



895mm

**52186** 72,00€

**8 Kg**

8.68 - 2 78



900mm



## MARTELO

### EN CUNHA

**51674** 7,75€

0.60 6 36 864



**505 g**

**52565** 11,50€

1.13 6 24 720



**1 Kg**



### MARTELO FORMA DE BOLA

**51918** 12,50€

1.25 6 18 432



**1 Kg**

**51504** 8,50€

0.55 4 40 800



**454 g**



### MÓDULO EVA MARTELOS - FIBRA DE CARBONO

**15799** 28,30€

1.35 - 10 200



## MARTELOS PROFSSIONAIS ANTI-RETROCESSO

**52180** 19,00€

**1,45 Kg**

355mm

1.45 6 12 432



**52183** 26,20€

**2,30 Kg**

405mm

2.30 6 12 288



**52181** 22,50€

**1,80 Kg**

370mm

1.81 6 12 300



## MARTELOS NYLON ANTI-RETROCESSO

**52425** 33,30€

Ø 40mm

0.70 6 12 768



**52426** 52,00€

Ø 60mm

1.50 2 12 288



### PUNTA RECAMBIO

REF.	Ø	Kg	Sub	ff	€
11212	40mm	0,02	5	100	5,00€
11213	60mm	0,08	5	50	10,60€
11214	70mm	0,11	5	100	12,50€



**52427** 64,00€

Ø 70mm

2.02 2 12 204





## MACHADO COM CABO DE MADEIRA

**52188** 15,50€



**52460** 16,60€



**52461** 25,70€



## SERRA COM CABO ERGONÔMICO

**52830** 24,00€

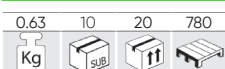

EM EXPOSITOR DE 10 UDS

## SERRA

**52831** 18,00€

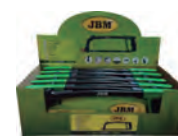
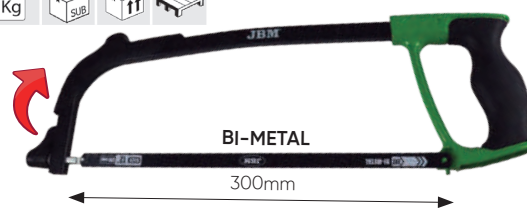

EM EXPOSITOR DE 10 UDS



FOLHA PARA SERRA PARA REF. 52830 / 52831 / 51675

**12060** 2,50€



## JOGO DE 5 LIMAS DE AÇO

**51853** 18,00€

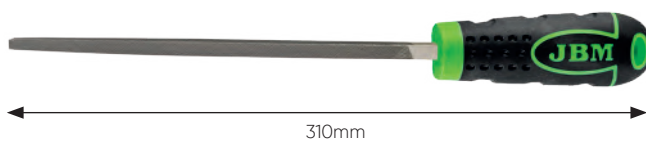
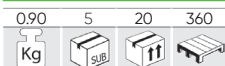

## JOGO DE 3 ESPÁTULAS DE AÇO

**51951** 15,60€



- Cabo ergonômico.



## KIT DE 4 ESPÁTULAS DE AÇO

**53339** 9,50€



2, 3, 4, 6"



IVA não incluído

## ESCOPRO

53120 6,00€

0.35	6	24	1200
Kg	Sub	ff	

150mm

ACO  
45C



53121 7,35€

0.55	6	24	840
Kg	Sub	ff	

250mm

53122 9,50€

0.90	6	12	720
Kg	Sub	ff	

350mm

## CONJUNTO DE 4 CINZÉIS

53083 64,00€

1.04	10	20	960
Kg	Sub	ff	

ACO  
SNCM+V

18x125,  
21x150,  
26x200,  
29x250mm



## JOGO DE 5 CINZÉIS

54089 17,50€

0.50	10	40	2240
Kg	Sub	ff	

5  
PCS

10, 11, 12, 14, 16mm



## MÓDULO DE CINZÉIS E PONTEIROS

15737 45,00€

9  
PCS

1.70	-	10	200
Kg	Sub	ff	

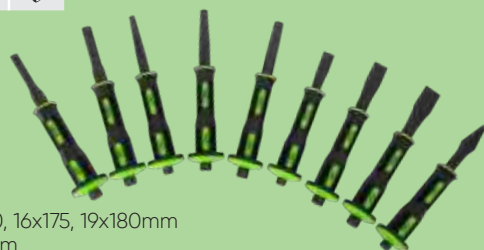

Conteúdos:

Escopro: 12x160, 16x175, 19x180mm  
 Guilho: 6x180mm  
 Punção central: 6x180, 8x180, 10x180mm  
 Punção de pino paralelo: 8x180, 10x180mm



## JOGO DE 5 PONTEIROS

52049 14,00€

0.40	10	40	3840
Kg	Sub	ff	

3, 4, 5, 6, 7mm



## JOGO DE 6 PONTEIROS

53095 20,50€

0.75	6	24	1152
Kg	Sub	ff	

CrV

3, 4, 5, 6, 7, 8mm

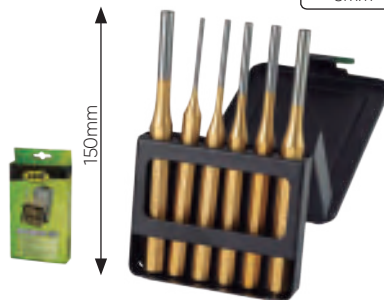

## JOGO DE 5 PONTEIROS

54099 13,80€

0.45	10	40	2240
Kg	Sub	ff	

4, 5, 6, 7, 8mm



## REBITADORA ARTICULÁVEL MULTI-FUNCIONAL

53993 77,00€

1.95	5	20	240
Kg	Sub	ff	

- Cabeça giratória de 360°
- Compacto, permite que você trabalhe facilmente em pequenos espaços
- O desenho permite o trabalho com uma mão

Inclui:

- Brocas de rebite padrão 2,4 mm (3/32") - 3,2 mm (1/8") - 4,0 mm (5/32") - 4,8 mm (3/16")
- Perfuradores para porcas de rebite M3x0.5 - M4x0.7 - M5x0.8 - M6x1
- Perfuradores para rebites M6x1 - M5x0.8 - M4x0.7
- 3 chaves 5,5x8,5mm - 12x17mm - 15x19mm
- Suporte de fuso M6x1 - M5x0.8 - M4x0.7 - M3x0.5"



M3x0.5  
M4x0.7  
M5x0.8  
M6x1

2,4mm (3/32")  
4,0mm (5/32")  
4,8mm (3/16")





## REBITADOR COMPACTO 200MM / 8"

52595 64,00€

1.30 - 10 280

Kg SUB if

300mm

M3, M4,  
M5, M6

8"



## MÁQUINA DE REBITES COMPACTA 200MM / 8"

52462 25,30€

0.55 5 30 600

Kg SUB if

200mm

8"



2,4mm (3/32)  
3,2mm (1/8)  
4,0mm (5/32)  
4,8mm (3/16)

MÁQUINA REBITES + REBITES EVA  
PARA CARRO DE FERRAMENTAS

13667 17,60€

0.83 - 10 360

Kg SUB if



## MÁQUINA DE REBITES 300MM / 12"

52463 26,10€

0.74 5 20 240

Kg SUB if

300mm

12"

3,2mm (1/8)  
4,0mm (5/32)  
4,8mm (3/16)



## MÁQUINA DE REBITES 400MM / 16"

52464 42,00€

1.25 5 10 180

Kg SUB if

400mm

16"

2,4mm (3/32)  
3,2mm (1/8)  
4,0mm (5/32)  
4,8mm (3/16)  
6,4mm (1/4)



## ALICATE DE REBITAR 400MM / 16"

52596 114,00€

3.07 - 5 60

Kg SUB if

400mm

16"

M3, M4, M5,  
M6, M8,  
M10, M12



## ALICATE DE REBITAR AUTOMÁTICO 440MM / 17"

52597 146,00€

3.25 - 5 80

Kg SUB if

440mm

17"

M3, M4, M5,  
M6, M8,  
M10, M12



## PEÇA DE REPOSIÇÃO PARA 52595, 52596, 52597



REF.	CARACTERÍSTICAS	Kg	if	€
13226	M3	0,03	100	4,50€
13227	M4	0,04	100	4,50€
13228	M5	0,04	100	4,50€
13229	M6	0,04	50	4,50€

REF.	CARACTERÍSTICAS	Kg	if	€
13230	M8	0,04	50	4,50€
13231	M10	0,05	100	4,50€
13232	M12	0,05	100	4,50€

IVA não incluído

**JBM** / [www.jbmcamp.com](http://www.jbmcamp.com)

## REBITADORA DE EMPURRAR 10"

**53331** 31,80€

0,80	5	20	280
Kg	Sub	ff	

250mm 10"

2,4mm (3/32)  
3,2mm (1/8)  
4,0mm (5/32)  
4,8mm (3/16)  
6,4mm (1/4)



## REBITADORA EXTENSÍVEL 8"

**53332** 34,50€

1,65	5	10	280
Kg	Sub	ff	

200mm 8"

2,4mm (3/32)  
3,2mm (1/8)  
4,0mm (5/32)  
4,8mm (3/16)



## REBITADORA + CAIXA DE REBITES PLÁSTICOS

**52609** 29,00€

0,45	5	20	300
Kg	Sub	ff	



Ø 6,6mm x 17,2mm (10 u.)  
Ø 6,3mm x 25,2mm (10 u.)  
Ø 5mm x 17,2mm (10 u.)  
Ø 5mm x 15,8mm (10 u.)



### REBITES PLÁSTICOS

REF.	Ø	Kg	Sub	ff	€
13674	6x19,3mm	0,01	25	1.000	0,50€
13675	6x17,8mm	0,01	25	1.000	0,50€
13676	6x25,5mm	0,01	25	1.000	0,50€
13677	6x24,5mm	0,01	25	1.000	0,50€
13678	6x24mm	0,01	25	1.000	0,50€

## REBITADOR PNEUMÁTICO

**52575** 119,00€

1,75	5	10	140
Kg	Sub	ff	

2,4mm (3/32), 3,2mm (1/8)  
4,0mm (5/32), 4,8mm (3/16)

- Tamanho: 3/16" - 5/32" - 1/8" - 3/32"
- Tração: 1586lbs / 720 kgs.
- Rod: 9/16" - 14mm.
- Binário max. 60FT LB / 23-69NM.
- Entrada de ar: 1/4".
- Consumo de ar médio: 0.03Cfm/0.86L/min.

- Inclui:
- 2 Multi-tool
  - Quick
  - O-rings

0,50€  
0,50€  
0,50€  
0,50€  
0,50€



REBITES DISPONÍVEIS EN PÁG. 51,319

## ROQUETE DE 72 DENTES COM CHAVES DE CAIXA

**54030** 18,80€

0,35	6	36	1008
Kg	Sub	ff	

1/4"

4, 5, 6, 7, 8, 9, 10, 11, 12, 13mm



**54028** 28,00€

1,30	4	24	432
Kg	Sub	ff	

1/2"

10, 11, 12, 13, 14, 15, 16, 17, 18, 19mm



**54031** 19,30€

0,35	6	36	864
Kg	Sub	ff	

1/4"

4, 5, 6, 7, 8, 9, 10, 11, 12, 13mm



**54029** 28,00€

1,25	4	24	432
Kg	Sub	ff	

1/2"

10, 11, 12, 13, 14, 15, 16, 17, 18, 19mm



72



# CONJUNTO DE 3 ROQUETES CURTOS

**53671** 41,00€

0,85 - 10 470

Kg SUB

- Completude:  
Alça de catraca curta de 1/4".  
Alça de catraca curta de 1/2".  
Alça de catraca curta de 3/8".

APRESENTAÇÃO EM EVA



72 3 PCS



KIT DE REPARAÇÃO PARA ROQUETE 1/2"	KIT DE REPARAÇÃO PARA ROQUETE 3/8"	KIT DE REPARAÇÃO PARA ROQUETE 1/4"
<b>15140</b> 13,50€	<b>15139</b> 12,00€	<b>15138</b> 10,50€
0,20 Kg	0,15 Kg	0,10 Kg
50	50	50

## ROQUETE DE 72 DENTES

CROMADO

**54022** 9,95€

0,15 12 36 2268

Kg SUB

1/4" 145mm

**54023** 13,50€

0,30 12 24 1440

Kg SUB

3/8" 200mm

**54024** 17,90€

0,60 12 24 960

Kg SUB

1/2" 255mm



ZINCADO

**54018** 9,85€

0,15 12 36 2016

Kg SUB

1/4" 145mm

**54021** 13,50€

0,60 12 24 1440

Kg SUB

3/8" 200mm

**54019** 17,90€

0,60 12 24 864

Kg SUB

1/2" 255mm



EM EXPOSITOR DE 12 UDS



EM EXPOSITOR DE 12 UDS

## ROQUETE DE 72 DENTES ZINCADA

**52207** 24,20€

0,05 12 240 8400

Kg SUB

1/4" 85mm



EM EXPOSITOR DE 12 UDS

## ROQUETE RETO DE 72 DENTES

**54083** 9,75€

0,14 12 24 2592

Kg SUB

1/4"

**54084** 13,10€

0,30 12 24 1440

Kg SUB

3/8"

**54085** 17,80€

0,60 12 24 960

Kg SUB

1/2"



EM EXPOSITOR DE 12 UDS

## ROQUETE RETO COMPACTO DE 72 DENTES

**54086** 9,25€

0,10 12 24 2592

Kg SUB

1/4"



**54087** 17,30€

0,50 12 24 1008

Kg SUB

1/2"



EM EXPOSITOR DE 12 UDS

IVA não incluído

## ROQUETE DE 72 DENTES ARTICULADA

**52587** 39,90€

0,16 12 144 3456



1/4" 175mm



**51305** 28,90€

0,31 12 48 816



1/2" 170mm



**51306** 28,10€

0,30 12 48 816



1/4" 175mm



**52588** 45,00€

0,17 12 144 3456



EM EXPOSITOR DE 12 UDS



EM EXPOSITOR DE 12 UDS

## ROQUETE DE 72 DENTES COM CABEÇA GIRATÓRIA

**51405** 21,10€

0,58 12 24 -



1/4" 145mm



**51406** 29,20€

0,66 12 24 864



1/2" 280mm



EM EXPOSITOR DE 12 UDS

## ROQUETE ARTICULADA EXTENSÍVEL DE 1/2" 72 DENTES

**52197** 36,30€

1,04 6 12 480



350-490mm 1/2"



ROTAÇÃO 180°

CABO EXTENSÍVEL



EM EXPOSITOR DE 6 UDS



## ROQUETE EXTENSÍVEL 72 DENTES

**53346** 18,00€

0,25 6 12 -



1/4" 150-200mm



EXTENSÍVEL



EM EXPOSITOR DE 6 UDS

**51307** 29,70€

0,92 6 12 456



1/2" 305-445mm



- Aço reforçado com tratamento térmico.

CABO EXTENSÍVEL



EM EXPOSITOR DE 6 UDS





## CATRACA ALONGADA DE 72 DENTES

**53886** 20,30€

0,27 10 40 1680

Kg SUB ITT

1/4" 305mm



REPUESTO 1/4" PARA REF.53886

**15149** 5,00€

0,05 100

Kg ITT

**53887** 30,30€

0,68 10 20 700

Kg SUB ITT

3/8" 457mm

REPUESTO 3/8" PARA REF.53887

**15147** 5,00€

0,10 100

Kg ITT

**53888** 37,90€

1,27 4 16 480

Kg SUB ITT

1/2" 609mm

REPUESTO 1/2" PARA REF.53888

**15148** 5,00€

0,20 100

Kg ITT



## CATRACA ALONGADA DE 72 DENTES

**53883** 18,40€

0,27 10 40 1680

Kg SUB ITT

1/4" 305mm



REPUESTO 1/4" PARA REF.53883

**15149** 5,00€

0,05 100

Kg ITT

**53884** 30,20€

0,61 10 20 700

Kg SUB ITT

3/8" 457mm

REPUESTO 3/8" PARA REF.53884

**15147** 5,00€

0,10 100

Kg ITT

**53885** 35,70€

1,25 4 16 480

Kg SUB ITT

1/2" 609mm

REPUESTO 1/2" PARA REF.53885

**15148** 5,00€

0,20 100

Kg ITT



## ROQUETE FLEXÍVEL DE 72 DENTES DE 3/8"

**51801** 62,00€

0,56 - 40 160

Kg SUB ITT

500mm 3/8"

- Ideal para locais de difícil acesso.



COM CABEÇA GIRATÓRIA

É OPERADO PELA ALÇA

## CHAVE DE RODA JUNTA SOLDADA

**51661** 12,00€

1,17 5 20 480

Kg SUB ITT

355mm 17, 19, 21mm 1/2"



**52881** 17,00€

1,40 - 10 420

Kg SUB ITT

400mm 17, 19, 21, 22mm 1/2"



**52880** 42,00€

3,75 - 5 100

Kg SUB ITT

700mm 24, 27, 32mm 3/4"

IVA não incluído

## ADAPTADOR DE ENCAIXE

**53478** 4,55€

0,50	5	100	1200
Kg	Sub	ff	

1/4" 115mm

**53468** 8,50€

0,35	6	48	600
Kg	Sub	ff	

1/2" 250mm

**53481** 27,40€

2,85	-	5	300
Kg	Sub	ff	

1" 550mm



**53479** 6,40€

0,15	5	50	300
Kg	Sub	ff	

3/8" 200mm

**53480** 19,90€

1,35	5	10	440
Kg	Sub	ff	

3/4" 460mm



## CHAVE ARTICULADA

**52524** 51,00€

3,60	3	6	180
Kg	Sub	ff	

3/4"

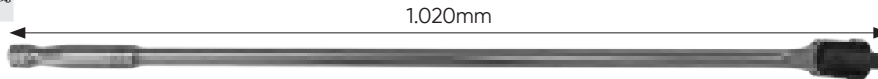

1.020mm



1/2" 11945

**52526** 28,40€

1,65	5	10	400
Kg	Sub	ff	

1/2"



600mm



1/2" 11946



3/4" 11947

**52525** 13,80€

0,85	10	20	1400
Kg	Sub	ff	

1/2"



430mm

REF.	"	PARA	Kg	Sub	ff	€
11945	1/2"	52526	0,15	25	100	7,00€
11946	1/2"	52525	0,51	100	300	4,50€
11947	3/4"	52524	0,60	10	40	19,00€

## KIT DE EXTENSOR 1/4"

**51447** 16,00€

0,34	5	20	960
Kg	Sub	ff	



1/4"

50, 75, 100, 152, 227mm

### REPOSIÇÕES DISPONÍVEI

REF.	mm	Kg	Sub	ff	€
14026	50mm	0,03	5	100	5,50€
14027	75mm	0,04	-	50	5,60€
14028	100mm	0,06	5	100	7,00€
14029	152mm	0,08	-	50	8,50€
14030	227mm	0,11	-	50	9,50€



## KIT DE EXTENSOR 1/4" COM PÉ REDONDO

**51805** 17,00€

0,33	4	20	640
Kg	Sub	ff	



1/4"

50, 75, 100, 152, 227mm

### REPOSIÇÕES DISPONÍVEI

REF.	mm	Kg	Sub	ff	€
12995	50mm	0,03	5	100	7,00€
12996	75mm	0,04	20	100	7,00€
12997	100mm	0,06	20	100	7,50€
12998	152mm	0,08	5	100	9,00€
12999	227mm	0,11	5	100	9,50€



## KIT DE EXTENSOR DE 1/2" COM PÉ REDONDO

**51448** 52,00€

2,38	-	5	270
Kg	Sub	ff	



1/2"

50, 125, 250, 380, 510mm

### REPOSIÇÕES DISPONÍVEI

REF.	mm	Kg	Sub	ff	€
14978	50mm	0,09	5	100	7,50€
14979	125mm	0,21	5	50	9,00€
14980	250mm	0,40	5	25	13,00€
14981	380mm	0,62	5	20	22,50€
14982	510mm	0,83	5	10	27,50€





## EXTENSOR EXTENSÍVEL DE 1/2" COM PÉ REDONDO

51479 31,80€

0.65 12 24 1056



260-410mm 1/2"



EM EXPOSITOR  
DE 12 UDS



6 POSIÇÕES

## PESCA PEÇAS FLEXÍVEL COM PONTA DE 4 GARRAS

51526 9,80€

0.10 12 144 2016



500mm Ø 20mm

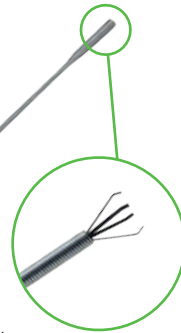

20mm

## PESCA PEÇAS MAGNÉTICO COM LED NA PONTA

52473 9,90€

0.18 10 60 1800



x1 545mm Ø 15mm

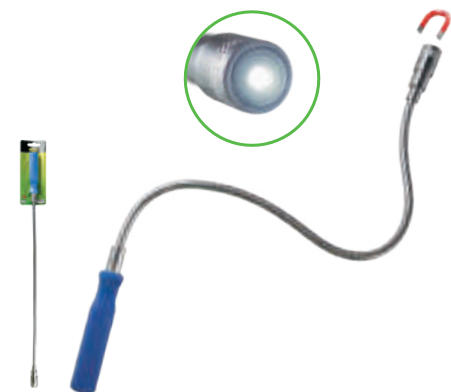

## PESCA PEÇAS MAGNÉTICO EXTENSÍVEL

52472 4,90€

0.15 12 108 4320



Ø 10mm 135-600mm



2,5 Kg

## PESCA PEÇAS FLEXÍVEL COM PONTA MAGNÉTICA

51525 9,80€

0.14 10 60 1440



500mm Ø 7mm



EXTRAFINO

0,5 Kg

## PESCA PEÇAS MAGNÉTICO COM PONTA DE LED

51272 7,50€

0.05 12 72 1512



90-810mm Ø 15mm x1



EM EXPOSITOR  
DE 12 UDS



## CONJUNTO DE GRIP MAGNÉTICO - 5 PEÇAS

15706 31,00€

0.55 - 10 240



5 PCS LED 360°

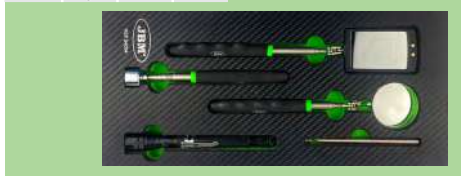

## MAGNETIZADOR / DESMAGNETIZADOR

53225 3,50€

0.10 12 96 2880



ABS

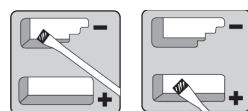

## ESPELHO TELESCÓPICO ARTICULADO

52468 5,90€

0.09 12 48 2688



280-445mm



Ø 50MM

# NAVALHA COM FUNÇÃO CORTA-CINTS E PONTEIRA QUEBRA-VIDROS

**52786** 14,60€

0,16 12 60 2100



COM SEGURO ANTIBLOQUEIO



## CORTA TUBOS

**52878** 11,20€

0,22 10 50 1500



3-32mm

**52879** 10,10€

0,24 10 50 1500



3-35mm

**53517** 9,50€

0,13 10 60 600



Ø max: 30mm

**52877** 15,80€

0,43 6 48 624



Ø max: 42mm



**52878**



**52879**



REF.	DESCRIÇÃO	PARA	Kg	€
12964	Rueda de acero	52878	0,01	1,50€
12965	Rueda de acero	52879	0,01	2,00€

## CURVA TUBOS 6-8-10mm

**52905** 28,00€

0,50 6 24 360



6, 8, 10mm

TUBOS EM ALUMÍNIO, COBRE E AÇO



GRAUS MARCADOS



## STRIPPER PARA A REMOÇÃO DE ISOLAMENTO DE FIOS

**53591** 5,50€

0,10 10 100 -



↑ 28mm  
↓ 8mm



- Faixa de corte: 8-28mm.
- Comprimento do produto: 170 mm.
- Comprimento da tela: 20mm.
- Profundidade do gancho: 5mm.



## ALICATES DE DESENCAPAR MINI

**53411** 5,00€

0,05 12 120 -



127mm



**53411**

**53412** 4,00€

0,05 12 120 -



94mm



**53412**

## ALICATE PARA EXTRAÇÃO DE GRAMPOS DE CARROCERIA

**53385** 19,30€

0,15 6 54 1026



CORTAR



SEGURAR



BORDEAR



- PONTA EM ÂNGULO:
- Desenhado para extrair/cortar molas /clips facilmente e sem danos.
  - Permite um fácil acesso a áreas pequenas.



# ALICATE DE TERMINAIS COM PONTA INTERCAMBIÁVEL

54254 43,00€

1.10 5 20 300



## ALICATE PARA DESENCAPAR FIOS AUTO-AJUSTAVEL

51972 12,00€

0,08-6mm

0.25 10 100 1000



- Para descamar cabos de plástico ou boracha, individual como múltiple, com seccões desde 0.25 a 2.5mm<sup>2</sup>.
- Ajuste automático de largura para descarnar diferentes fios.
- Em cabos de cobre ou alumínio, possibilidade de descamar vários cabos de uma vez a partir de 2.5mm<sup>2</sup> como máximo.
- Possibilidade descamar cabo individual a partir de 0.25m<sup>2</sup>.
- Não provoca danos no fio condutor.
- Alta durabilidade.

## ALICATE PARA TERMINAIS

PARA TERMINAIS PRÉ-ISOLADOS E NÃO ISOLADOS

52761 8,00€

9"

0.25 12 72 1800



53932 8,00€

9"

0.25 12 72 1296



ALICATE MULTIUSOS + TERMINALES EVA PARA CARRO DE FERRAMENTAS

13669 18,00€ 0.61 10



## PARA TERMINAIS NÃO ISOLADOS

52762 9,00€

8 - 3/4"

0.25 12 72 1800



## TESOURAS DE ELECTRICISTA

52152 13,50€

0.08 12 96 1920



ACO INOXIDÁVEL 145mm 45mm

## ALICATES DE DESENCAPAR MINI

53604 118,00€

Seção de corte max. Ø 550 mm2

3.70 - 5 120



800mm

53603 45,00€

Seção de corte max. Ø 250 mm2

1.75 - 5 300



550mm

53602 30,50€

Seção de corte max. Ø 125 mm2

0.60 - 5 300



360mm



53602 53603 53604

## CORT CAVILHAS

52955 19,80€

0.77 - 20 200



12" 300mm HRC 30 Ø 4-5mm

52957 23,80€

1.47 - 12 360



18" 450mm HRC 30 Ø 6-8mm

52959 42,00€

3.78 - 5 100



30" 750mm HRC 30 Ø 10-13mm

52960 46,00€

5.15 - 5 105



36" 900mm HRC 30 Ø 12-16mm

52956 19,60€

0.95 - 20 200



14" 350mm HRC 30 Ø 5-7mm

52958 28,20€

2.40 - 8 210



24" 600mm HRC 30 Ø 8-10mm



52955 52956 52957 52958 52959 52960

IVA não incluído

JBM www.jbmcamp.com

## ALICATE SEEGER BOCA RETA

PARA INTERIORES

**53549** 14,30€



13" 330mm



**52964** 9,45€

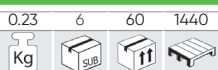

9" 225mm

**51018** 7,05€



7" 180mm

PARA EXTERIORES

**53547** 14,70€

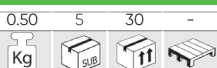

13" 330mm



**52966** 9,45€

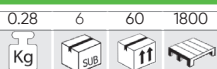

9" 225mm

**51017** 6,80€



7" 180mm

CrV



## ALICATE SEEGER BOCA CURVA

PARA INTERIORES

**53550** 14,70€



13" 330mm



**52965** 9,20€

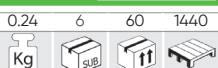

9" 225mm

**51021** 7,05€



7" 180mm

PARA EXTERIORES

**53548** 15,60€

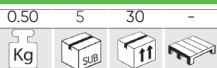

13" 330mm



**52967** 9,40€

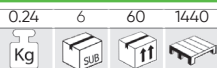

9" 225mm

**51020** 6,65€



7" 180mm

CrV



## MÓDULO ALICATES SEEGER EVA 8"

**15454** 35,40€

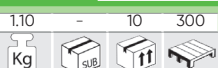

	Ø	Kg	€
15707	ALICATE SEEGER PARA INTERIORES BOCA RETA 8"	0,21	10,00€
15708	ALICATE SEEGER PARA EXTERIORES BOCA RETA 8"	0,22	10,00€
15709	ALICATE SEEGER PARA INTERIORES BOCA CURVA 8"	0,21	10,00€
15710	ALICATE SEEGER PARA EXTERIORES BOCA CURVA 8"	0,22	10,00€



8"

## KIT DE ALICATES SEEGER COM PONTA INTERCAMBIÁVEL

**53389** 31,50€



Ángulo de puntas: 90° / 45° / 15° / 0° 10"

- Contiene:
- Alicates interno.
  - Alicates externo.
  - 16 puntas de diferentes ángulos.
  - 8 tornillos.



## ALICATE EXTENSÍVEL

**52052** 53,00€



**50567** 9,60€

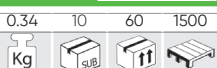



## ALICATE EXTRA-LONGO

RETO

52846 37,80€

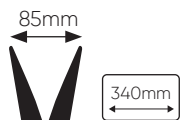

CURVADO 45°

52847 41,00€

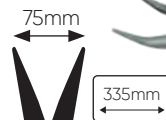

## JOGO ALICATES PONTA 0°, 45°, 90°

52272 24,60€

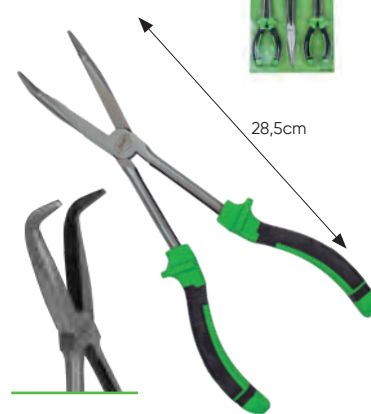
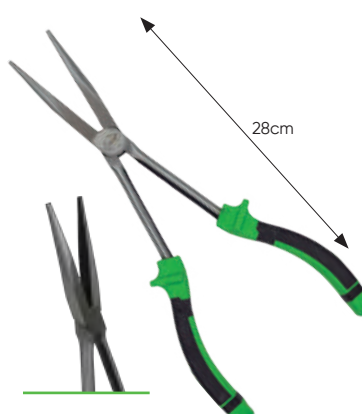
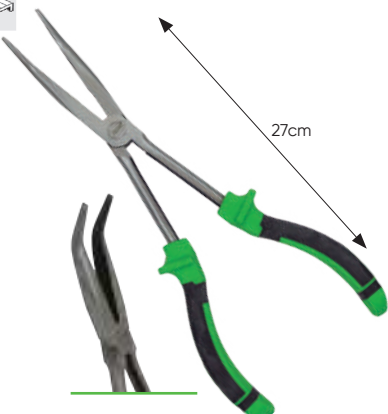

## JOGO DE 5 ALICATES EM ESTOJO

51812 46,00€



## ALICATE MINI MULTIUSOS

52412 5,00€

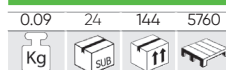

105mm



### CONTÉM

- x2 chaves de fenda plano
- x1 ponta estrela
- x1 saca-rolhas
- x1 abre-latas
- x1 lima 25mm
- x1 folha de serra 40mm
- x1 folha de corte 40mm

IVA não incluído

**JBM** / [www.jbmcamp.com](http://www.jbmcamp.com)

## ALICATE PARA ABRAÇADEIRAS

**53390** 34,50€

1.00	10	20	320
Kg	sub	ff	ff



CONJUNTO DE PEÇAS DE REPOSIÇÃO PARA 53390

<b>14180</b>	0.01	100
7,90€	Kg	ff

**51995** 24,50€

0.53	5	40	360
Kg	sub	ff	ff



CONJUNTO DE PEÇAS DE REPOSIÇÃO PARA 51995

<b>14179</b>	0.01	100
8,50€	Kg	ff

## ALICATE PARA ABRAÇADEIRAS DE TUBOS DE ESCAPE

**53396** 18,30€

0.50	5	50	-
Kg	sub	ff	ff

17-70mm

310mm



## ALICATE PARA ABRAÇADEIRAS CLIC-R

**52791** 18,00€

0.25	5	50	1500
Kg	sub	ff	ff

175mm



- Para o tipo de Clic e Click-R.



## ALICATE UNIVERSAL

**53911** 8,80€

0.20	6	60	1440
Kg	sub	ff	ff

160mm

6"

**53967** 10,20€

0.30	6	60	1440
Kg	sub	ff	ff

200mm

8"

**54015** 10,20€

0.20	6	60	1920
Kg	sub	ff	ff

180mm

7"

CrV



## ALICATE DE PONTA ESPECIAL TERMINAIS

**53976** 9,00€

0.20	6	60	1440
Kg	sub	ff	ff

160mm

6"

CrV



## ALICATE DE CORTE DIAGONAL

**53905** 7,30€

0.20	6	60	1440
Kg	sub	ff	ff

6"

160mm

**53906** 8,65€

0.20	6	60	1440
Kg	sub	ff	ff

7"

184mm

CrV



## ALICATE DE PONTA ALARGADA

**53908** 7,25€

0.15	6	60	1440
Kg	sub	ff	ff

6"

160mm

CrV

**53909** 9,70€

0.20	6	60	1440
Kg	sub	ff	ff

8"

200mm





# JOGO DE ALICATES PARA ABRAÇADEIRAS

**52050** 98,00€

3,24 - 4 60



- Alicates para braçadeiras que permitem a extração de braçadeiras auto-ajustáveis de plástico ou de ferro com diâmetros de 18mm a 47mm.
- Alicates para braçadeiras com ponta "+".
- Alicates para braçadeiras com ponta giratória.
- Alicates para braçadeiras lisas. A ponta gira 360° para agarrar em qualquer ângulo. Para braçadeiras modernas.
- Alicates para extração de tubos, muito útil para a fácil extração de tubos de vazio e combustível de 5/32" até 1/2".
- Alicates de Anel clic-R. Para desapertar e reajustar abraçadeiras reajustáveis de tipo click o click-R.



REF.	DESCRIÇÃO	Kg	SUB	ff	€
13707	alicate para braçadeiras elásticas com ponta giratória	0,25	10	40	14,00€
13708	alicate para braçadeiras elásticas	0,25	10	40	14,00€
13709	alicate para braçadeiras elásticas com ponta recta	0,24	10	40	14,00€
13710	alicate para braçadeiras elásticas 45°	0,21	10	40	14,00€

REF.	DESCRIÇÃO	Kg	SUB	ff	€
52791	alicate para braçadeiras "clic" y "clic-r"	0,27	10	50	18,00€
13712	alicate para la extração de tubos	0,21	10	40	14,00€
51995	alicate para abraçadeiras	0,59	5	40	24,50€



## ALICATE PARA ABRAÇADEIRAS

**52619** 23,10€

0,55 6 36 648

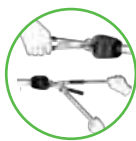

0-20mm

- Furros 1/2" lida para utilizar como uma chave.



**52812** 65,00€

0,85 5 20 500



- Soquete feminino de 3/8" para apertar con roquete.

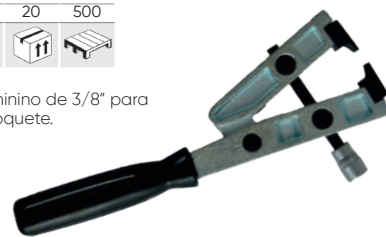

## ALICATE PARA TUBO DE COMBUSTÍVEL

**53487** 16,70€

0,30 10 40 960



Audi / VW, Fiat, GM, Mercedes

## ALICATE ABRAÇADEIRAS

**52508** 38,40€

0,37 10 50 800



0-38mm



**52509** 36,20€

0,39 10 50 800



22-55mm



240mm

IVA não incluído

**JBM** / [www.jbmcamp.com](http://www.jbmcamp.com)

## CONJUNTO DE GANCHO, PICARETA E PÉ DE CABRA

54142 15,20€

0.10	6	48	1344
Kg	Sub	ff	ff

Ferramentas para extração, limpeza e trabalho com clips plásticos, juntas, cabos, conectores eléctricos, etc.  
- Não danifica materiais macios  
- Não arranha a pintura

6 PCS

Conteúdo:  
2 pontas de gancho  
2 pontas retas  
2 pontas anguladas  
6 pontas com alavancas



## CONJUNTO DE 2 PEÇAS RISCADOR

52852 6,80€

0.06	25	100	3200
Kg	Sub	ff	ff

- Para a remoção de O-rings.



## JOGO 12 VAZADORES

52885 18,00€

1.10	5	20	600
Kg	Sub	ff	ff

3, 4, 5, 6, 7, 8, 9, 10, 12, 14, 16, 19mm

12 PCS

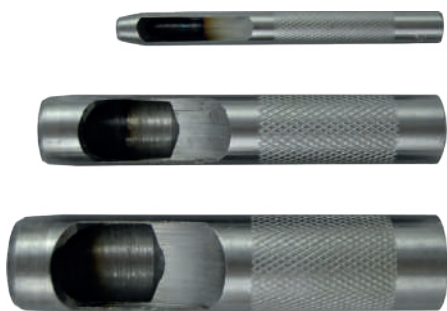

## ALICATE PARA MOLAS DE TRAVÃO

52625 9,00€

0.35	6	48	1824
Kg	Sub	ff	ff

- Para remoção e instalação de molas de retorno em freios a tambor.



## ALICATE ESPECIAL PARA PESOS

51355 19,00€

0.45	5	50	-
Kg	Sub	ff	ff

- Tira facilmente e substitui o peso.  
- Corta e dobra com facilidade.  
- Feito de aço reforçado.  
- Inclui cabo ergonómico.  
- Com mola automática para manter a sua abertura e facilitar a operação.



## GRAMPEADOR INDUSTRIAL

53589 12,00€

0.55	20	40	920
Kg	Sub	ff	ff

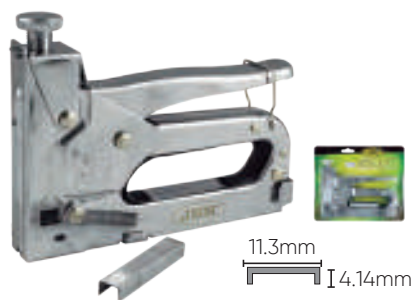

1008J-1

PACOTE DE GRAMPEADORES 1000 PCS. PARA REF.53589

14167

2,50€ 0.10 100

## ALICATE PERFORADORA ROTATIVA

52638 9,95€

0.35	5	50	1800
Kg	Sub	ff	ff

Ø 2, 2.5, 3, 3.5, 4, 4.5mm



## ESCOVAS METÁLICAS

52760 4,10€

0.09	6	120	2160
Kg	Sub	ff	ff



52515 9,10€

0.14	6	72	800
Kg	Sub	ff	ff

- 1x Latão.  
- 1x Nylon.  
- 1x Aço.





## KIT DE CHAVES INGLESAS DE GANCHO

**53654** 81,00€

- Kit composto por 3 chaves de gancho, 3 adaptadores e 2 passadores intercambiáveis.  
- Sua combinação permite trabalhar com diâmetros de 35 mm a 120 mm.

**8**  
PCS

1.40	-	5	180
Kg	sub	ff	tr

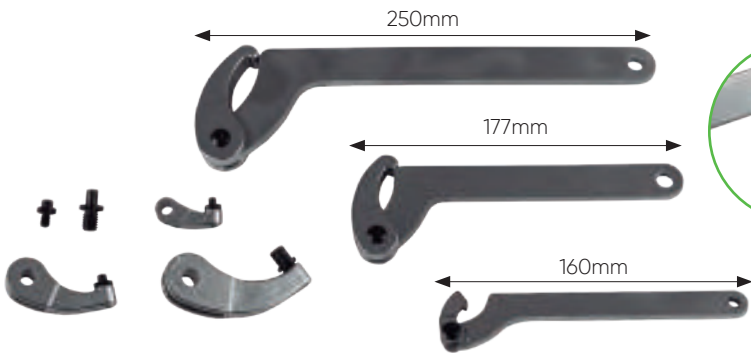

35-60, 60-90,  
90-120mm

## CONJUNTO PARA CORTA PORCAS

**53524** 51,00€

9-12, 12-16,  
16-22, 22-27mm

**4**  
PCS

1.70	5	10	320
Kg	sub	ff	tr

### REPOSIÇÕES DISPONÍVEI

REF.	DESCRIÇÃO	Kg	sub	ff	tr	€
14049	9-12mm	0,11	50			8,00€
14050	12-16mm	0,2	50			10,50€
14051	16-22mm	0,44	5	20		18,00€
14052	22-27mm	0,65	5	20		19,50€



## CHAVE INGLESA

### MODELO 3

**53639** 28,60€

0.15	6	96	576
Kg	sub	ff	tr

**6"** 150mm

**53640** 34,40€

0.28	6	72	504
Kg	sub	ff	tr

**8"** 200mm

**53641** 41,00€

0.50	6	36	1151
Kg	sub	ff	tr

**10"** 250mm



**53642** 54,00€

0.83	6	10	1200
Kg	sub	ff	tr

**12"** 300mm

**53643** 92,00€

1.53	-	12	336
Kg	sub	ff	tr

**16"** 400mm



### MODELO 1

**51798** 39,60€

1.90	3	12	480
Kg	sub	ff	tr

**18"** 53mm

**52424** 64,00€

3.75	-	5	250
Kg	sub	ff	tr

**24"** 62mm



### MODELO 2

**51795** 9,00€

0.28	6	60	3600
Kg	sub	ff	tr

**8"** 22mm

**51796** 14,00€

0.48	6	36	2400
Kg	sub	ff	tr

**10"** 28mm

**51797** 18,00€

0.71	6	24	960
Kg	sub	ff	tr

**12"** 37mm



**51795**



**51796**  
**51797**

## CHAVE DE GRIFO

**52235** 11,00€

0,90 6 24 1140



**12"** 300mm 50mm

**52236** 13,30€

1,09 6 24 760



**14"** 350mm 60mm

**52237** 18,10€

1,75 4 12 720



**18"** 450mm 70mm

**52238** 24,90€

2,50 2 8 600



**24"** 600mm 75mm

**53210** 48,00€

4,95 - 4 96



**36"** 915mm 100mm



## ALUMÍNIO ALLOY CHAVE DE GRIFO

**53070** 16,20€

0,68 6 24 900



**12"** 270mm

**53071** 26,10€

0,92 4 12 900



**14"** 320mm

**53072** 31,60€

1,35 4 12 900



**18"** 410mm

**53073** 50,00€

2,05 2 8 1000



**24"**



## SARGENTO

**52349** 22,10€

1,25 - 10 480



90x200mm

**52354** 34,40€

2,41 - 6 300



120x500mm

**52350** 22,60€

1,41 - 10 540



90x300mm

**52355** 36,60€

2,62 - 4 300



120x600mm

**52351** 25,40€

1,60 - 10 480



90x400mm

**52357** 54,00€

4,60 - 5 125



150x800mm

**52352** 32,40€

1,99 - 10 360



120x300mm

**52358** 63,00€

5,35 - 5 120



150x1.000mm

**52353** 33,40€

2,10 - 10 350



120x400mm



52351  
52352  
52355  
52357

52349  
52350  
52353  
52354  
52358





# MOBILIÁRIO DE OFICINA

- 68 CARROS DE FERRAMENTAS
- 76 MÓDULOS DE FERRAMENTA
- 80 ACESSÓRIOS  
/ PEÇAS PARA AUTOMÓVEIS
- 81 ARMÁRIOS
- 81 ACESSÓRIOS PARA MESAS
- 82 MESAS DE TRABALHO
- 83 CAIXAS DE FERRAMENTAS
- 85 BANCOS / ESTRADOS
- 86 BIGORNAS / PARAFUSOS DE BANCO

# CARRO DE 12 GAVETAS

53939 1.280,00€

53868 1.090,00€

172 PCS

98.70	-	1	4
Kg	Sub	ff	

83.50	-	1	4
Kg	Sub	ff	

COM FERRAMENTAS

VAZIO



PROTETOR LATERAL



SISTEMA DE FECHO COM CHAVE



GAVETAS COM FECHO INDIVIDUAL

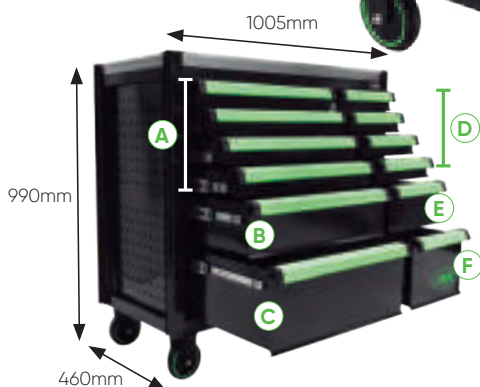

COM MÓDULOS EVA:  
4 MÓDULOS COM ACABAMENTO EM FIBRA DE CARBONO

53708 325,00€

15.20	-	1	24
Kg	Sub	ff	

## ACESSÓRIOS E PEÇAS DE REPOSIÇÃO

página 80

### MEDIDAS INTERIOR 1ª COLUNA

GAVETAS MENINHAS (x4)



GAVETA MEDIANA (x1)



GAVETA GRANDE (x1)



### MEDIDAS INTERIOR 2ª COLUNA

GAVETAS MENINHAS (x4)



GAVETA MEDIANA (x1)



GAVETA GRANDE (x1)



Módulo 1: 14296 118,00€



Módulo 2: 14297 87,00€



Módulo 3: 14298 51,50€



Módulo 4: 14299 87,00€





# CARRO 7 GAVETAS - XL

<b>53912</b> 1.280,00€	<b>53869</b> 990,00€	<b>53913</b> 1.280,00€	<b>53870</b> 990,00€	<b>199 PCS</b>
74,50 - - 4 <b>COM FERRAMENTAS</b>	74,50 - 1 4 <b>VAZIO</b>	74,50 - - 4 <b>COM FERRAMENTAS</b>	74,50 - 1 4 <b>VAZIO</b>	

**SISTEMA DE BLOQUEIO COM CHAVE**

**SUPERFÍCIE DE TRABALHO DE AÇO INOXIDÁVEL**

**PUNHO ERGONÓMICO, MACIO E ANTIDERRAPANTE**

**LATERAIS PERFURADAS PARA UM GRANDE NÚMERO DE ACESSÓRIOS**

**MANUSEIO SEGURO: RODAS GIRATÓRIAS, 2 COM TRAVÃO**

**GAVETAS COM FECHO INDIVIDUAL**

**MEDIDAS INTERIORES**

**GAVETAS MENINHAS (x5)**

74mm	705mm	400mm	<b>25kg</b>
------	-------	-------	-------------

**GAVETAS GRANDES (x2)**

151,5mm	705mm	400mm	<b>35kg</b>
---------	-------	-------	-------------

## COM MÓDULOS EVA: **XL** ACESSÓRIOS E PEÇAS DE REPOSIÇÃO página 80

<b>Módulo 2:</b> 14296 118,00€	<b>15122</b> 74,00€	<b>Módulo 1:</b> 14297 87,00€	<b>15161</b> 62,00€
<b>Módulo 4:</b> 14298 51,50€	<b>15155</b> 59,00€	<b>Módulo 3:</b> 14299 87,00€	<b>15514</b> 9,35€

IVA não incluído

**ARMÁRIOS**

# CARRO DE 7 GAVETAS

**53763** 890,00€

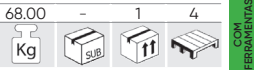

**53764** 680,00€

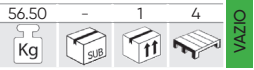

**53765** 890,00€

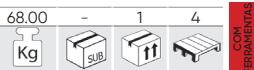

**53766** 680,00€

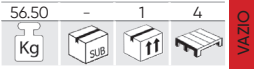

**53900** 890,00€

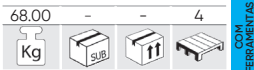

**53901** 680,00€

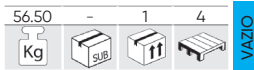

172  
PCS

350Kg



## ALTA QUALIDADE

- RESISTENTE A CARGAS PESADAS
- LEVE E FÁCIL DE TRANSPORTAR
- FERRAMENTAS BEM ORGANIZADAS EM MÓDULOS
- CONSTRUÇÃO ROBUSTA E DURÁVEL

LATERAIS PERFORADAS PARA PERMITIR AO USUÁRIO ADICIONAR UM GRANDE NÚMERO DE ACESSÓRIOS



FECHO INDIVIDUAL POR GAVETA



SISTEMA DE FECHAMENTO CENTRALIZADO

RODAS DE 5", 2 RODAS FIXAS E 2 GIRATÓRIAS, UM COM TRAVÃO

COM MÓDULOS EVA:  
4 MÓDULOS COM ACABAMENTO EM FIBRA DE CARBONO

**53708** 325,00€

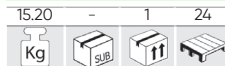

Módulo 1: **14296** 118,00€



## ACESSÓRIOS E PEÇAS DE REPOSIÇÃO

página 80

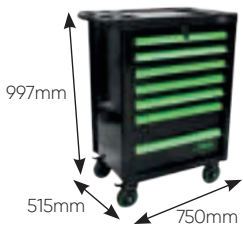

GAVETAS MENINHAS (x6)



GAVETA GRANDE (x1)

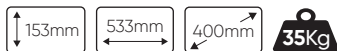

CAPACIDADE DE CARGA POR GAVETA: 40KG.  
CAPACIDADE TOTAL DE CARGA: 125KG.

Módulo 2: **14297** 87,00€

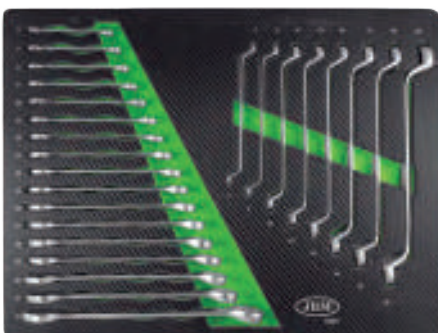

Módulo 3: **14298** 51,50€



Módulo 4: **14299** 87,00€





# CARRO DE 7 GAVETAS

**53661** 890,00€

71,50 Kg 1 SUB 1 4

COM FERRAMENTAS

**53686** 890,00€

72,50 Kg 1 SUB 1 4

COM FERRAMENTAS

**53761** 680,00€

52,50 Kg 1 SUB 1 4

VAZIO

**53762** 680,00€

55,50 Kg 1 SUB 1 4

VAZIO

**53767** 890,00€

64,00 Kg 1 SUB 1 4

COM FERRAMENTAS

**53904** 890,00€

72,00 Kg 1 SUB 1 4

COM FERRAMENTAS

**53768** 680,00€

56,00 Kg 1 SUB 1 4

VAZIO

**54006** 680,00€

55,00 Kg 1 SUB 1 4

VAZIO



**172 PCS**

**300 Kg**

**ACESSÓRIOS E PEÇAS DE REPOSIÇÃO**  
página 80

## INCLUÍDO NO CARRO:

**4 MÓDULOS COM ACABAMENTO EM FIBRA DE CARBONO COM MÓDULOS EVA:**

**53708** 325,00€

15,20 Kg 1 SUB 1 24



1/2" x1	5/16
1/2" x5	14, 15, 17, 19 y 22 mm
1/2" x17	10, 11, 12, 13, 14, 15, 16, 17, 18, 19, 20, 21, 22, 24, 27, 30 y 32 mm
1/2" x8	E10, E11, E12, E14, E16, E18, E20 y E24
1/2" x2	16, 21
x2	5", 10"
1/2" x1	3/8" 1/2"
x1	3/8" 1/2"
1/4"	1,2
x18	3,4,5,6 mm
	4,5,5,6,5 mm
	8,10,15,20,25,27,30 mm
1/4"	2", 3"
x13	4, 4,5, 5, 5,5, 6, 7,8, 9,10, 11, 12, 13 y 14 mm
1/4" x8	6, 7, 8, 9,10, 11, 12, 13 mm
1/4" x5	E4, E5, E6, E7 y E8
	7, 8, 10, 12, 14 mm
	8, 10, 12 mm
8mm x17	3,4
	3,4
	40, 45, 50, 55, 60 mm
x3	1,5, 2, 2,5 mm



6x7 8x9 10x11 12x13 14x15 16x17 18x19 20x22 m
6 7 8 9 10 11 12 13 14 15 16 17 18 19 20 21 22

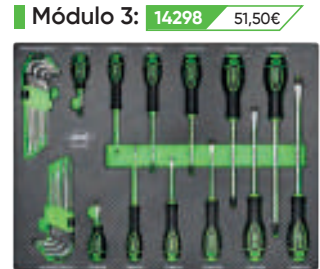

x6	PH2x38, PH0x75, PH1x100, PH2x100, PH3x150, PH4x200
x4	SL6x38, SL3x100, SL8x150, SL10x200
x9	
x9	



450g
35mm
10"
8"
10"
7,5"
8"
3m



2 RODAS GIRATÓRIAS

SISTEMA DE FECHAMENTO CENTRALIZADO

**GAVETAS MENINHAS (X5)**

74mm x 533mm x 400mm **35Kg**

**GAVETA GRANDE (X2)**

151,5mm x 533mm x 400mm **35Kg**

CAPACIDADE DE CARGA POR GAVETA: 35KG.  
CAPACIDADE TOTAL DE CARGA: 300KG.



IVA não incluído

# CARRO DE FERRAMENTAS 7 GAVETAS ESPECIAL PARA CAMIÕES

54240 1.887,00€

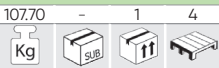

54237 1.887,00€

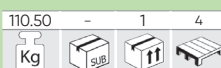

54238 1.887,00€



54239 1.887,00€



## CONJUNTO DE FERRAMENTAS DE REPARAÇÃO DE CAMIÕES

54134 1.415,00€



15734 288,50€



	1kg
	24, 27, 30, 32, 36, 41mm
	3/4" 500mm
	3/4" 500mm

15732 293,50€



	10, 13, 17 mm
	10x11, 12x13, 14x17mm
	E10xE12, E14xE18, E20xE24
	8x10, 11x13, 14x15, 16x17, 18x19mm
	27, 30, 32, 36mm
	10, 13, 17, 19mm

15731 214,00€



	6x7, 8x9, 10x11, 12x13, 14x15, 16x17, 18x19, 20x22, 21x23, 24x27, 25x28, 30x32mm
	6, 7, 8, 10, 11, 12, 13, 14, 15, 17, 19, 22, 24mm

15736 488,50€



	1/2" 78mm	13,14,15,16,17,18,19,21,22,24
	3/4" 110mm	22,24,27,30,32,33,36,38,46mm
	1/2" 90mm	51,60mm
	1/2"	T40,T45,T50,T60,T70
	1/2" 78mm	H6,H8,H14,H17
	3/4" 100mm	T80,T90,T100
		1/2"(M)x3/4"(H) 3/4"(M) x1/2"(H)
		1/2", 3/4"
		125mm
	1/2" 40mm	M18

15735 152,00€



	250mm
	6" - 180mm
	7" - 180mm
	90° 300mm
	45° 300mm
	0° 300mm
	220mm
	330mm
	330mm
	330mm

15730 289,00€

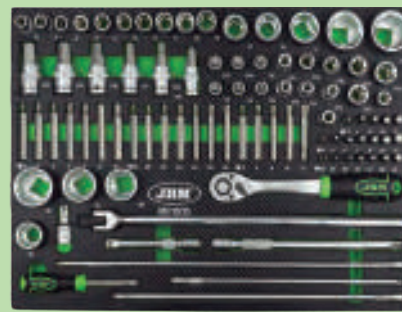

	55mm	H5, H6, H7, H8, H10, H12
	65mm	H14
	70mm	H16, H17, H18, H18, H20
	30mm	H4, H5, H6, H7, H8, H10, H12
	75mm	M5, M6, M8, M10, M12
		T20, T25, T30
		T40, T45, T50, T55
		H4, H5, H6, H7, H8, H10, H12
		M5, M6, M8, M10, M12
		T20, T25, T30
		T40, T45, T50, T55

15733 113,00€



	PH0*75mmL,
	PH1*75mmL,
	PH2*100mmL,
	PH2*38mmL,
	PH3*150mmL,
	PH4*200mmL
	SL3.5*75mmL,
	SL5*75mmL,
	SL6*100mmL,
	SL6*38mmL,
	SL8*150mmL,
	SL9.5*200mmL
	10x11, 12x13, 14x15mm
	10x11, 12x13, 14x15, 16x17, 18x19mm

	1/2" 72	
	1/2" X9	E10, E11, E12, E14, E16, E18, E20, E22, E24
	1/2" X10	10, 11, 12, 13, 14, 15, 16, 17, 18, 19mm
	1/2" x3	50, 125, 250mm
	1/2" x1	430mm
	1/2" x1	10mm
	3/4" x5	21, 24, 27, 34, 36mm
	3/4" x4	24, 30, 32, 36 mm
		1/2x10mm 3/8x10mm
		1/2x10mm 3/8x10mm
	3/8"	10mm
	1/4"	
	1/4"	300, 380, 450mm



# CARRO DE 7 GAVETAS - ESPECIAL VEÍCULOS ELÉTRICOS

54236 1.856,00€

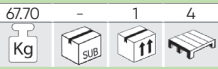

54233 1.856,00€

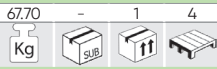

54234 1.856,00€

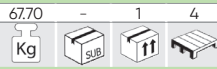

54235 1.856,00€

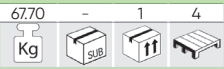

- x1** MÓDULO EVA DE FERRAMENTAS ISOLADAS
- x1** TERMÔMETRO LÁSER -50°C A 550°C
- x1** PROTEÇÃO FACIAL ISOLANTE PARA TRABALHOS SOB TENSÃO
- x1** CARRO QUE FERRAMENTAS 7 GAVETAS
- x1** GANCHO DE RESGATE ISOLADO - 45KV
- x1** MEDIDOR DE RESISTÊNCIA DE ISOLAMENTO
- x1** LUVAS ISOLANTES PARA TRABALHOS SOB TENSÃO
- x1** TAPETE ISOLANTE CLASSE 0
- x8** ELO DE FECHAR PRETO
- x4** CORRENTE DE PVC - 5M - AMARELO/PRETO
- x4** POSTE DE PLÁSTICO PARA CORRENTE - AMARELO / PRETO



PROTEÇÃO FACIAL ISOLANTE PARA TRABALHOS SOB TENSÃO

54132 190,00€

54093 441,00€  
MÓDULO DE FERRAMENTAS VDE COM ISOLAMENTO DE EVA (ETILENO ACETATO DE VINILA)

TERMÔMETRO LÁSER -50°C A 550°C

52162 38,00€

**x8** TAMPA DE ELO AMARELA

53942 0,50€

**x4**

CORRENTE DE PVC - 5M - AMARELO/PRETO

53941 6,05€

**x4** POSTE DE PLÁSTICO PARA CORRENTE - AMARELO / PRETO

53940 13,20€

TAPETE ISOLANTE CLASSE 0

54129 110,00€

MEDIDOR DE RESISTÊNCIA DE ISOLAMENTO

54114 248,00€

CARRO DE 7 GAVETAS VAZIO

54006 680,00€

GANCHO DE RESGATE ISOLADO - 45KV

54241 120,00€

LUVAS ISOLANTES PARA TRABALHOS SOB TENSÃO T.9

54130 58,00€

ARMÁRIOS



# CARRO COM 7 GAVETAS ESPECIAL KIT DE BLOQUEIO

53951 1.794,00€

53952 1.794,00€

53775 1.109,00€

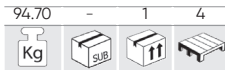
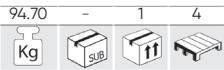

pg.244

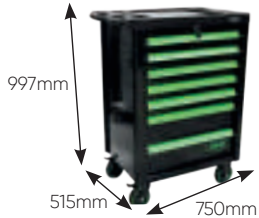

Módulo 5: 53773 298,00€  
FIAT / ALFA / LANCIA / OPEL / SUZUKI / FORD



Módulo 6: 53774 190,00€  
OPEL / CHEVROLET / SAAB / FIAT / LANCIA / SUZUKI / FORD



SET DE 6 MÓDULOS DE KIT DE BLOQUEIO

GASOLINA/PETROL

GASOIL/DIESEL

Módulo 1: 53769 178,00€

RENAULT / NISSAN / OPEL / VOLVO



Módulo 2: 53770 198,00€

FORD / SEAT / VOLKSWAGEN / MAZDA / VOLVO

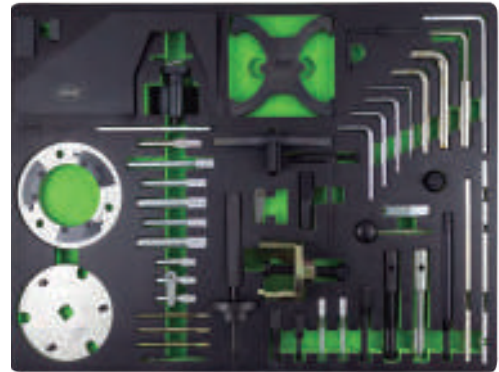

Módulo 3: 53771 158,00€

FIAT / FORD / CITROËN / PEUGEOT



Módulo 4: 53772 229,00€

FORD / VAG / MAZDA / VOLVO



+ INFORMAÇÕES DE CADA CONFIGURAÇÃO: KIT DE BLOQUEIO, pág. 238





Escolha a cor e o kit que mais se adapta à vossa necessidade

# FERRAMENTAS PARA CARROÇARIA OU FERRAMENTAS DE MANUTENÇÃO

## CARRO DE FERRAMENTAS 7 GAVETAS ESPECIAL CARROÇARIA

<b>53577</b> 990,00€	<b>53579</b> 990,00€	<b>53580</b> 990,00€	<b>53578</b> 990,00€	<b>256 PCS</b>
74,50 - 1 2	74,50 - 1 2	74,50 - 1 2	74,50 - - -	

### Módulo 1:

**14059** 62,00€ MANÍVELAS DE NYLON



### Módulo 2:

**14060** 65,00€ CONJUNTO DE NIVELAMENTO

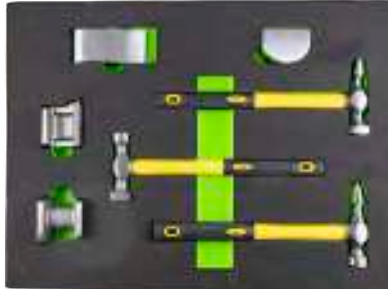

### Módulo 3:

**14061** 93,00€ BANDEJA COM UM ALICATE



### Módulo 4:

**14062** 100,00€ BOMBA DE SUÇÃO E FERRAMENTAS DE REMOÇÃO DE PÁRA-BRISAS



### Módulo 5:

**14063** 119,00€ FERRAMENTAS PARA ENTALHES



### Módulo 6:

**14064** 39,50€ PARA ABERTURA DE EMERGÊNCIA



## CARRO DE FERRAMENTAS 7 GAVETAS ESPECIAL MANUTENÇÃO

<b>53514</b> 990,00€	<b>53556</b> 990,00€	<b>53557</b> 990,00€	<b>256 PCS</b>
74,50 - 1 2	74,50 - 1 2	74,50 - 1 2	

### 53469

613,00€

JOGO DE 5 MÓDULOS PARA CARRO DE TROCA DE ÓLEO:

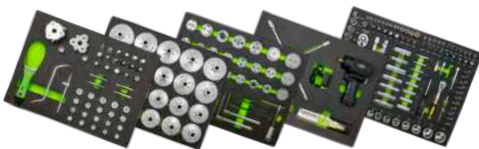

### Módulo 1:

**14141** 105,00€ EXTRATORES DE FILTRO DE ÓLEO



### Módulo 2:

**14142** 109,00€ REPOSICIONADOR DE FREIO

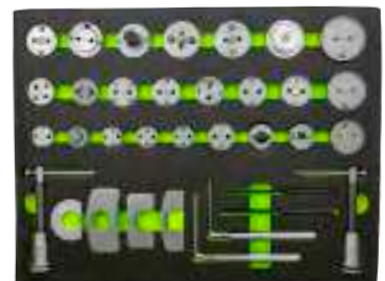

### Módulo 3:

**14143** 124,00€ TAMPÃO CARTER E EXTRATORES DE FILTRO DE ÓLEO AJUSTÁVEIS



### Módulo 4:

**14144** 304,00€ PISTOLA E VASOS DE IMPACTO



### Módulo 5:

**14296** 118,00€ 108 PEÇAS CHAVES HEX.

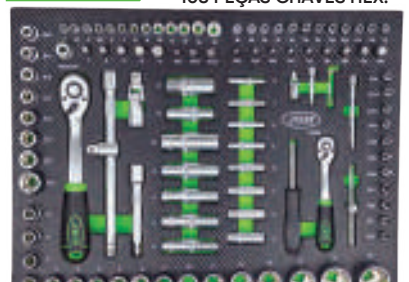

ARMÁRIOS



# CARRO DE 7 GAVETAS COM GUÍA TELESCÓPICA COM E SEM FERRAMENTAS

**52393** 1.180,00€

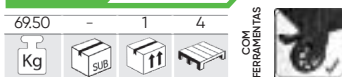

**52172** 780,00€

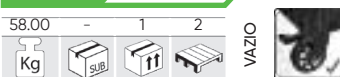

- Rodas sem montar.

- espessura do metal:  
Gaveta: 0,8mm  
Quadro: 1mm

**179**  
PCS



**SUPERFÍCIE DE BORRACHA ANTIDESLIZANTE**



**FECHO COM CHAVE**



**RODAS COM FREIOS**



125x50mm

1010mm

676mm

460mm

**MEDIDAS INTERIOR**

**GAVETAS PEQUENAS (x5)**



**GAVETAS GRANDES (x2)**



**COM MÓDULOS EVA:**

**53708** 325,00€

**Módulo 1:** 14296 118,00€

**Módulo 2:** 14297 87,00€

**Módulo 3:** 14298 51,50€

**Módulo 4:** 14299 87,00€

**4 MÓDULOS COM ACABAMENTO EM FIBRA DE CARBONO**

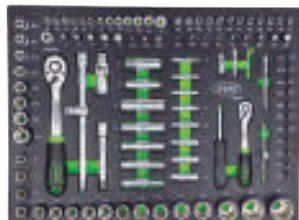

## CARRO DE 9 GAVETAS

**53867** 1.095,00€

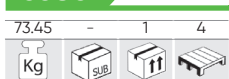

**ACESSÓRIOS E PEÇAS DE REPOSIÇÃO**

página 80

**COM SEPARADORES**



**ORGANIZAÇÃO LIVRE**

**18**  
PCS

INCLUÍDO NO CARRO

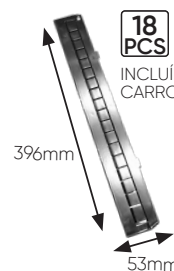

**21**  
PCS

INCLUÍDO NO CARRO



997mm

476mm

740mm

**TAMBÉM PODE INTERESSAR...**

REF.	mm	Kg	11	€
15070	67x53mm	0,05	200	0,50€
15071	103x53mm	0,05	200	0,60€
15072	138x53mm	0,05	200	0,70€
15074	210x53mm	0,10	200	1,00€
15075	280x53mm	0,10	200	1,20€

**15076** 3,50€

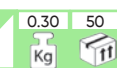

**15073** 1,00€



**MEDIDAS GAVETA INTERIOR**





# CARRO DE FERRAMENTAS COM 1 GAVETA

53866

424,00€

35,00	-	1	4
Kg	Sub	ff	



350Kg

## ACESSÓRIOS E PEÇAS DE REPOSIÇÃO

página 80



BANDEJA / DIVISÓRIA AJUSTÁVEL



SISTEMA DE FECHAMENTO CENTRALIZADO

SUPERFÍCIE DE BORRACHA ANTIDESLIZANTE

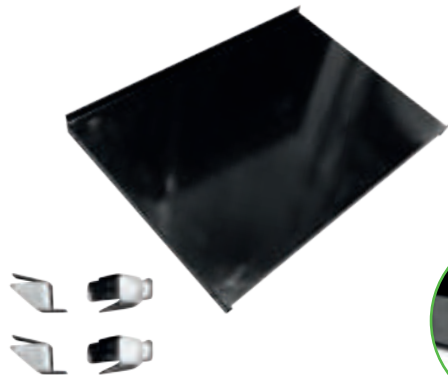

MEDIDAS GAVETA INTERIOR

75mm	533mm	400mm	35Kg
------	-------	-------	------



# MÓDULOS DE FERRAMENTAS

## MÓDULO DE CHAVES PARA BUJÃO DE CARTER

15084

68,00€

1,70	-	-	-
Kg	Sub	ff	

MÓDULO COM ACABAMENTO EM FIBRA DE CARBONO



30mm	380mm	175mm
------	-------	-------

➤ VOCÊ PODE GOSTAR...

15018 1,45 10  
46,00€ Kg ff

MÓDULO VAZIO PARA 15018

15083 8,50€  
0,05 - 20 480  
Kg Sub ff

### CONTÉM

	x2	5/16", 3/8"
	x7	7, 8, 10, 11, 12, 13, 14mm
	x1	10mm
	x1	10mm
	x7	8, 9, 10, 12, 13, 14, 17mm
	x1	T45
	x1	M16
	x1	200mm
	x1	150mm



Também adequado para coletores de óleo 53873 e 53874.

IVA não incluído

**JBM** / [www.jbmcamp.com](http://www.jbmcamp.com)

# MÓDULOS EVA 175x30x380mm

MÓDULOS DE FERRAMENTAS

<b>15734</b> 288,50€  pg.70 18,00 Kg 2 48	<b>15732</b> 293,50€  pg.70 12,00 Kg 2 48	<b>15731</b> 214,00€  pg.70 12,00 Kg 2 48	<b>15735</b> 152,00€  pg.70 10,00 Kg 2 48
<b>15730</b> 289,00€  pg.70 20,00 Kg 2 48	<b>15736</b> 488,50€  pg.70 29,00 Kg 2 40	<b>15733</b> 113,00€  pg.70 7,00 Kg 2 48	

## CONJUNTO DE 4 MÓDULOS COM ACABAMENTO EM FIBRA DE CARBONO EVA

**53708** 325,00€

30mm x 525mm x 380mm

15,20 Kg 1 24

**14296** 118,00€

6,05 Kg 4 80

**14297** 87,00€

3,30 Kg 4 96

**14296**

	1/2" x17	10, 11, 12, 13, 14, 15, 16, 17, 18, 19, 20, 21, 22, 24, 27, 30, 32mm
	1/4" x13	4, 4.5, 5, 5.5, 6, 7, 8, 9, 10, 11, 12, 13, 14mm
	1/2" x5	14, 15, 17, 19, 22mm
	1/4" x8	6, 7, 8, 9, 10, 11, 12, 13mm
	1/2" x8	E10, E11, E12, E14, E16, E18, E20, E24
	1/4" x5	E4, E5, E6, E7, E8
	72	1/2" - 1/4"
	1/2" x2	125, 250mm
	1/4" x2	50, 100mm
	x2	
	1/2" x1	
	1/2" x2	16, 21mm
	1/2" x1	8mm
	x3	1.5, 2, 2.5mm
	x1	1/4"
	x1	1/4"
	x2	PH3, PH4
	x2	PZ3, PZ4
	8mm x5	7, 8, 10, 12, 14mm
	x3	SL8, SL10, SL12
	x5	T40, T45, T50, T55, T60
	x2	PH1, PH2
	x2	PZ1, PZ2
	1/4" x4	3, 4, 5, 6mm
	x3	SL4, SL5.5, SL6.5
	x8	T8, T10, T15, T20, T25, T27, T30

**14298** 51,50€

2,10 Kg 4 96

**14299** 87,00€

3,25 Kg 4 96

**14298**

	PH0x75, PH1 x 100, PH2 x 100, PH3 x 150, PH4 x 200
	6, 7, 8, 10, 11, 12, 13, 14, 15, 17, 19, 22mm
	2x38mm
	6x38mm
	1.5, 2, 2.5, 3, 4, 5, 6, 8, 10mm
	TX10, 15, 20, 25, 27, 30, 40, 45, 50

**14297**

	6x7, 8x9, 10x11, 12x13, 14x15, 16x17, 18x19, 20x22mm
	6, 7, 8, 10, 11, 12, 13, 14, 15, 17, 19, 22mm

**14299**

	x1	8"
	x1	10"
	10"	7.5"
	8"	3m
	8"	



# MÓDULOS EVA COM ACABAMENTO EM FIBRA DE CARBONO

210x50x120mm



**15122** 74,00€

1.70 Kg 10 200

8, 9, 10, 11, 12, 13, 14, 15, 16, 17, 18, 19mm



**15155** 59,00€

2.45 Kg 10 180

8, 10, 11, 12, 13, 14, 15, 16, 17, 18, 19mm



**15156** 70,00€

2.05 Kg 10 180

21x23, 24x27, 25x28, 30x32 mm



**15157** 42,00€

0.95 Kg 10 300

6x8, 10x12, 13c14, 15x17, 19x21, 22x24 mm



**15158** 59,00€

1.30 Kg 10 240

8, 10, 11, 13, 14, 17, 19 mm



**15159** 44,00€

0.75 Kg 10 300

8x10, 11x13, 14x15, 17x19, 20x22 mm



**53943** 21,50€

0.80 Kg 10 240

PH4x200, PH3x150, PH2x100, PH2x38 PH1x80, PH0x120, PH1x100



**53944** 19,50€

0.80 Kg 10 240

SL9x200, SL4x125, SL5x100, SL5x80, SL6x38, SL6x100, SL8x150mm



**53945** 18,90€

0.60 Kg 10 240

T8x75, T9x75, T10x75, T15x75, T20x75, T25x100, T27x100



**54158** 38,00€

1.70 Kg 8 200

3/8"	x1	10mm
1/2"	x1	10mm
30mm	x7	4, 5, 6, 7, 8, 10, 12mm
75mm	x7	4, 5, 6, 7, 8, 10, 12mm
30mm	x8	T20, T25, T30, T40, T45, T50, T55, T60
75mm	x8	T20, T25, T30, T40, T45, T50, T55, T60
30mm	x5	M5, M6, M8, M10, M12
75mm	x5	M5, M6, M8, M10, M12



**15160** 42,00€

0.80 Kg 10 300

8x9, 10x11, 12x13, 14x15, 16x17, 18x19 mm



**15161** 62,00€

2.10 Kg 10 180

27, 29, 30, 32 mm



**15316** 58,00€

0.85 Kg 10 260

8, 9, 10, 11, 12, 13, 14, 15, 16, 17, 18, 19mm



**15454** 35,40€

1.10 Kg 10 300

8"



**15541** 27,60€

0.95 Kg 10 220

MÓDULOS DE FERRAMENTAS



210x50x120mm

15514 9,35€



0.05 10 360  
Kg it

15162 30,20€



0.65 10 240  
Kg it

Dimensões: SL 6.5x150mm Voltímetro  
SL 3x75mm PH 0x75mm 140mm, sulco  
SL 4x100mm PH 1x80mm SL 0,5x3,0 mm  
SL 5.5x125mm PH 2x100mm

15706 31,00€



0.55 - 10 240  
Kg it

15737 45,00€



1.70 - 10 200  
Kg it

15315 28,20€



1.05 - 10 260  
Kg it

MÓDULOS DE FERRAMENTAS



175x50x460mm

51864 64,00€

1.87 - 10 210  
Kg it



10x11mm (290mmL),  
12x14mm (330mmL),  
13x15mm (368mmL),  
16x18mm (407mmL),  
17x19mm (407mmL),  
22x24mm (430mmL)

52912 91,00€

1.62 - 10 210  
Kg it

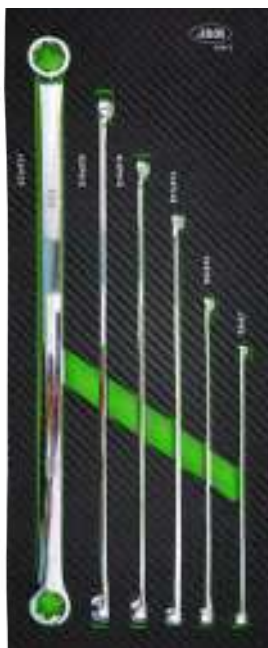

E6xE7 (200mmL),  
E8xE10 (235mmL),  
E11xE12 (290mmL),  
E14xE16 (370mmL),  
E18xE20 (410mmL),  
E22xE24 (420mmL)

54066 83,00€

2.00 - 5 175  
Kg it



8mm (23,5mmL)  
10mm (29,3mmL)  
12mm (32,8mmL)  
13mm (34,9mmL)  
14mm (36,7mmL)  
17mm (41mmL)  
19mm (42mmL)



520x50x390mm

15681 134,00€

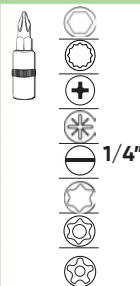
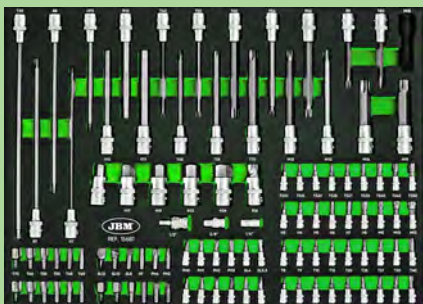

H3, H4, H5, H6, H7, H8
M8, M10, M12
PH0, PH1, PH2, PH3
PZ0, PZ1, PZ2, PZ3
1/4"
SL4, SL5.5, SL6.5, SL7
T8, T9, T10, T15, T20, T25, T27, T30, T40
T8, T9, T10, T15, T20, T25, T27, T30, T40
TS10, TS15, TS20, TS25, TS27, TS30, TS40, TS45, TS50
1/2"
H7 (230mmL), H10, H11, H13 (140mmL), H14, H17, H19, H22, H24 (55mmL)
M9 (100mmL), M10, M12, M14 (140mmL), M16 (53mmL), M16 (100mmL)
R7, R8 (240mmL), R9 (100mmL), R10 (140mmL)
T30 (300mmL), T40, T45, T50, T55, T60, T70 (140mmL), T80 (100mmL)
HT5 (160mmL)

1/2"	8mm
3/8"	8mm
1/4"	6mm
1/2"	M18
8mm	7, 8, 10, 12, 14mm
	PH3, PH4
	PZ3, PZ4
	SL8, SL10, SL12
	T40, T45, T50, T55, T60, T70
	T40, T45, T50, T55, T60, T70



15799 28,30€



1.35 - 10 200  
Kg 5.9 11 15

16111 19,20€



0.61 - 10 360  
Kg 5.9 11 15

11996 48,00€



2.10 - 10 300  
Kg 5.9 11 15

6x7mm - 20x22mm +  
24x27mm + 30x32mm

11997 39,00€

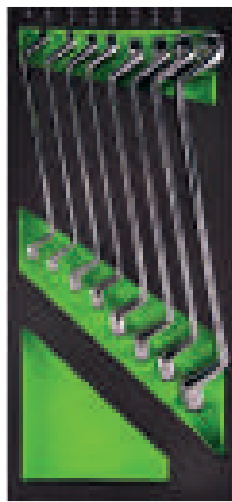

1.92 - 10 360  
Kg 5.9 11 15

6x7mm - 18x19mm +  
20x22mm

11998 49,00€



1.96 - 10 300  
Kg 5.9 11 15

6x7mm - 18x19mm -  
20x22mm



11994 33,00€



1/4"  
0.68 - 10 233  
Kg 5.9 11 15

14114 19,30€



0.93 - 10 360  
Kg 5.9 11 15

13923 7,45€

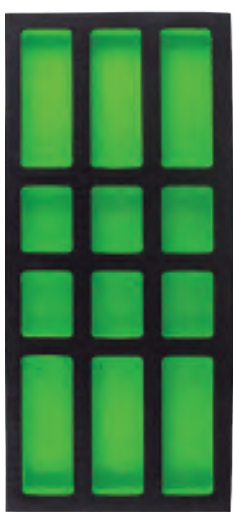

0.05 - 30 1299  
Kg 5.9 11 15

13667 17,60€



0.83 - 10 360  
Kg 5.9 11 15

13668 18,70€



0.61 - 10 300  
Kg 5.9 11 15

## MÓDULOS DE PLÁSTICO

10731 17,60€



0.68 - 10 233  
Kg 5.9 11 15

10732 18,70€



0.70 - 10 220  
Kg 5.9 11 15

10733 17,50€



0.69 - 10 220  
Kg 5.9 11 15

10735 20,30€



0.98 - 10 300  
Kg 5.9 11 15

53671 41,00€



210x50x120mm

72

1/4" - 85 mm  
1/2" - 135 mm  
3/8" - 102 mm

0.85 10 470  
Kg 11 15

53620 88,00€

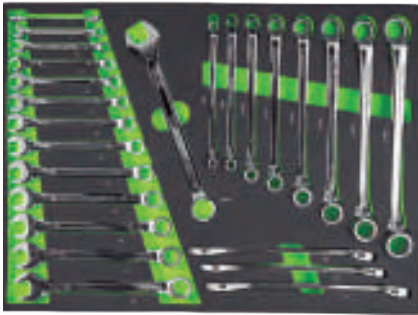

3.52 4 112  
Kg

6x78,9,10x11,12x13,  
14x15,16x17,18x19,20  
x22mm  
6,7,8,9,10,11,12,13,  
14,15,16,17,18,19, 20,  
21,22mm

54093 441,00€



3.52 4 112  
Kg

51447 16,00€



0.34 5 20 960  
Kg

50mm, 75mm, 100mm,  
152mm, 227mm

53979 34,60€

340x50x390mm

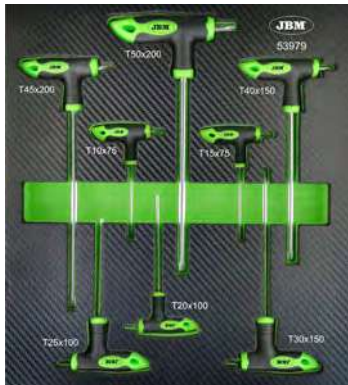

1.00 180  
Kg

H2x100, H2.5x100, H3x100,  
H4x150, H5x150, H6x200,  
H8x200, H10x200

53980 34,60€

340x50x390mm



1.00 10 180  
Kg

T10X75, T15X75, T20X100,  
T25X100, T30X150,  
T40X150, T45X200,  
T50X200mm

51805 17,00€



0.33 4 20 640  
Kg

50mm, 75mm, 100mm,  
152mm, 227mm

51448 52,00€

130x50x540mm



2.38 - 5 270  
Kg

50mm, 125mm, 250mm, 380mm, 510mm

## ACESSÓRIOS PARA ARMARIOS

COMPATIBILIDADE

53764/53765/53766/53767/53768/53769/53770/  
53900/53901/53902/53912/53913

PORTA SRPAYS  
E ACESSÓRIOS

15313 14,00€

0.60 1 340  
Kg



PORTA SPRAYS

14354 14,00€

0.60 1 184  
Kg



SUPORTE DE ROLO DE PAPEL

15068 15,20€

0.65 25 500  
Kg



PORTA DOCUMENTOS

15069 32,80€

1.65 1 80  
Kg



COMPATIBILIDADE

53686/53762/53661 53761/53767/53768/53904/54006

SUPORTE DE ROLO DE PAPEL

16161 17,50€

0.65 25 -  
Kg



PORTA DOCUMENTOS

16162 35,10€

1.65 1 -  
Kg



SUPORTE DE CILINDRO  
DE AEROSSOL

16163 10,20€

0.60 1 -  
Kg



16188 39,60€

2.00 25 -  
Kg



PEÇAS DE REPOSIÇÃO PARA ARMARIOS REF. 53661, 53686, 53763, 53764, 53765, 53766, 53866, 53867,  
53868, 53869, 53870, 53900, 53901, 53904

REF.	DESCRIÇÃO	Kg	Caixa	Unidade	€	COMPATIBILIDADE
14578	Guia de rolagem de esferas grande	1,05	1	25	12,50€	53661, 53686, 53904
14580	Tampa superior	2,60	3	39	41,00€	53661, 53686, 53904
14783	Protetor direito	0,25	1	50	5,50€	53661, 53686, 53904
15023	Roda fixa	0,65	1	10	12,50€	53765, 53766, 53870
15024	Roda giratória	0,95	1	8	15,00€	53765, 53766, 53870
15025	Roda fixa	0,65	1	10	12,50€	53900, 53901
15026	Roda giratória	0,95	1	8	15,00€	53900, 53901
15030	Puxador gaveta	0,30	1	50	8,00€	53765, 53766
15033	Puxador gaveta estreita	0,30	1	50	6,00€	53868
15034	Tampa superior	-	-	-	57,00€	53868
15035	Puxador gaveta	0,36	1	20	8,50€	53869
15036	Puxador gaveta	0,36	1	20	8,50€	53870
15037	Puxador gaveta	-	-	-	8,00€	53900, 53901
15038	Tampa superior	-	-	-	34,50€	53869, 53870
15040	Roda fixa	0,66	1	10	12,50€	53904
15041	Roda giratória	0,98	1	8	15,00€	53904
15042	Puxador gaveta	0,10	1	-	7,50€	53904
15050	Puxador gaveta	0,10	1	50	9,50€	53661, 53686
15058	Protetor lateral	-	-	-	7,50€	53868
15065	Protetor lateral	0,55	1	12	6,50€	53869, 53870



14580, 15034,  
15038



14783



15030, 15035,  
15036, 15037,  
15042, 15050



15033



14783



15058, 15065



15023, 15025,  
15040



15024, 15026,  
15041



## CARRO COM 3 BANDEJAS

51576

125,00€

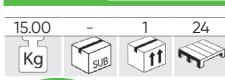

## CARRO COM 3 BANDEJAS MAXI

52373

252,00€

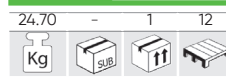

150Kg

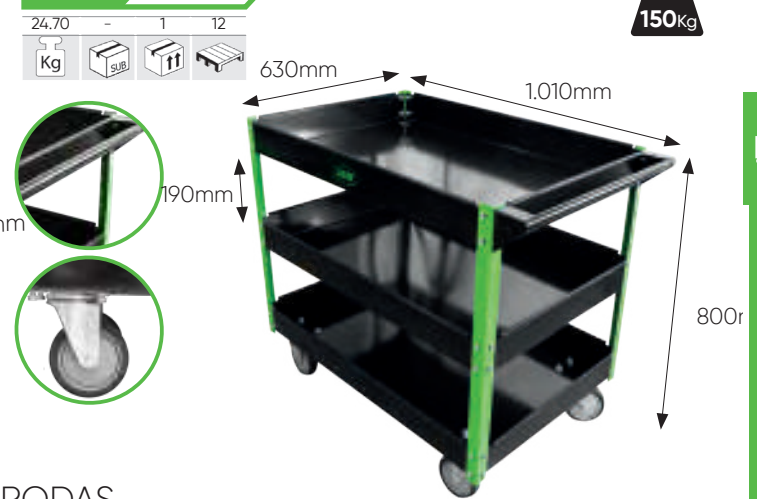

## ARMÁRIO DE TRABALHO MULTIMÉDIA COM RODAS

51456

550,00€

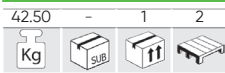

- Rodas sem montar.

SET DE 4 RODAS PARA ARMÁRIO REF. 51456

Ø12cm  
2 Rodas com freio + 2 simples

11313

54,00€

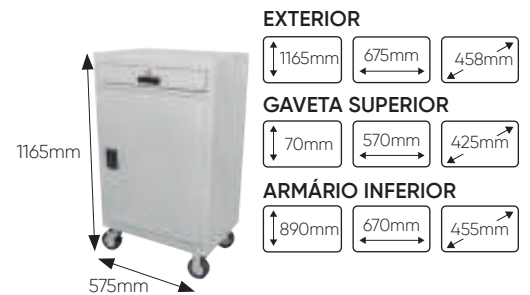
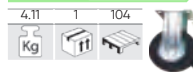

## PAINEL PARA FERRAMENTAS

52419

80,00€

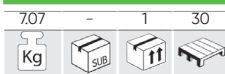

1.000 x 600mm

52420

108,00€



1.500 x 600mm

52421

172,00€

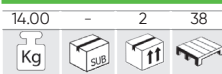

2.000 x 600mm



ACOPLAMENTO QUADRADO

## GANCHOS

### GANCHO ESPECIAL CHAVES DE FENDA

51657

5,85€

PARA REF.:  
52419, 52420, 52421

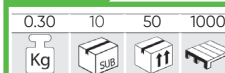

### GANCHO ESPECIAL CHAVES

51653

5,10€

PARA REF.:  
52419, 52420, 52421



PARA REF. 52419, 52420, 52421

95mm GANCHO DE PONTA FECHADA

51654

4,80€

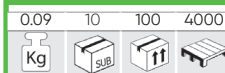

31mm GANCHO DE 2 PONTAS PEQUENAS

51655

4,10€

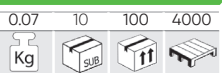

200mm GANCHO DE 2 PONTAS LONGA

52634

5,25€

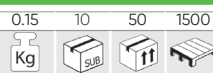

200mm GANCHO DE PONTA FECHADA LONGA

52635

4,80€

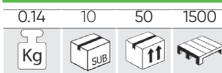

92mm GANCHO DE 2 PONTAS COMPRIDAS LONGAS

51658

4,50€

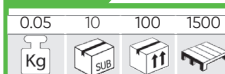

91mm GANCHO DE PONTA COMPRIDA LONGAS

51656

3,65€



95mm GANCHO "L" DUPLO LONGO

51422

2,97€



PARA REF. 51035, 53661, 53686, 53761, 53762, 53767, 53768, 53904

GANCHO "L" DUPLO LONGO 95mm

51422

2,97€



PARA REF. 51428, 51430, 52705, 52706, 52707, 52708, 52709

GANCHO "L" SIMPLE LONGA 90mm

51419

2,79€



GANCHO CURTO 30mm

51975

2,27€



GANCHO 2 PONTAS LONGAS 75mm

51976

1,63€



## MESA DE TRABALHO COM PAINEL FRONTAL

**51035** 799,00€

MEDIDAS GAVETA INTERIOR

600Kg

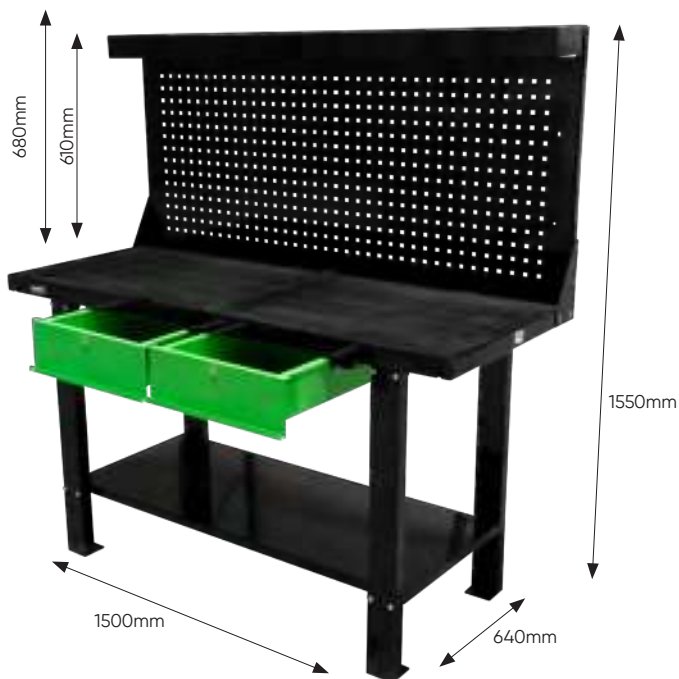
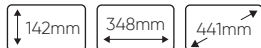

CONJUNTO DE 2 TAPETES DE BORRACHA PARA MESA DE TRABALHO, NO. 51737

**15145** 20,45€



## MESA DE TRABALHO COM 3 GAVETAS

**51738** 850,00€

MEDIDAS GAVETA INTERIOR

1T

50Kg

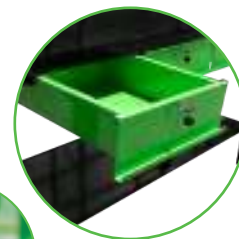
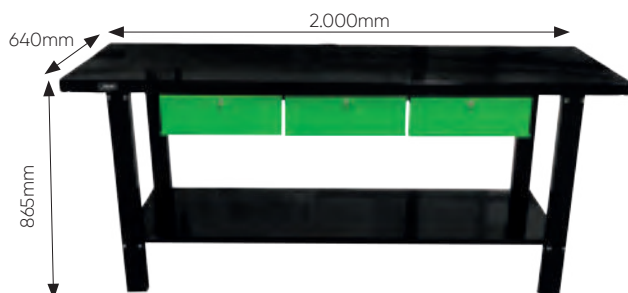
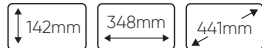

MAT DE BORRACHA

**15144** 30,00€



## MESA DE TRABALHO COM 2 GAVETAS

**51737** 699,00€

MEDIDAS GAVETA INTERIOR

800Kg

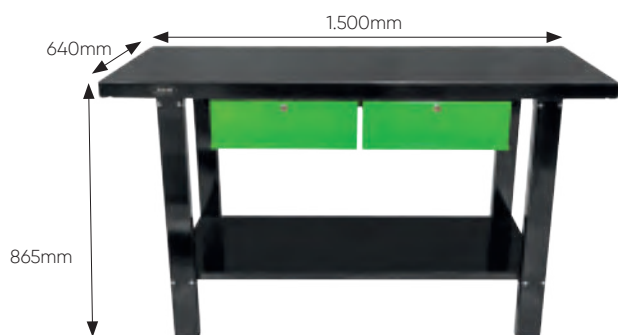
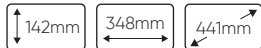

TAPETE DE BORRACHA

**15145** 20,45€



## MESA DE TRABALHO COM 1 GAVETA

**53674** 447,00€

MEDIDAS GAVETA INTERIOR

800Kg

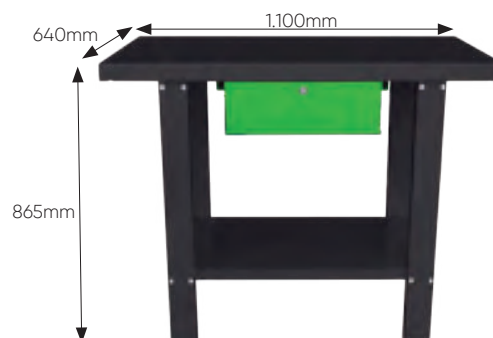
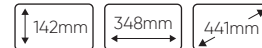

TAPETE DE BORRACHA

**15146** 16,20€





# CARRO MODULAR

53672

440,00€

23,00 - 1 6  
Kg SUB 11

90  
PCS



3 COMPARTIMENTOS  
DESMONTÁVEIS  
E SEPARÁVEIS

PODEM SER USADOS  
INDIVIDUALMENTE  
OU JUNTOS



PUNHO SUPERIOR EM CADA MÓDULO PARA  
FACILITAR O TRANSPORTE INDIVIDUAL



FECHO COM CADEADO  
(NÃO INCLUIDO)

3 MÓDULOS INDEPENDENTES  
EQUIPADOS COM:



	1/2" x11	8,10,11,12,13,14,16,17,19,21,22mm
	1/4" x13	4,4,5,5,5,5,6,7,8,9,10,11,12,13,14mm
	1/2" x2	125,300mm
	1/4" x2	50,100mm

	1/4" x1	
	1/4" x1	
	1/4" x1	
	1/2" x1	
	1/4" x1	
	x8	1,5x8mm
	x1	3m
	1/4" x32	



	x1	180mm
	x1	160mm
	x2	160mm, 180mm
	x2	PH2x125, PH1x100mm
	x2	6x150mm, 5x100mm



	x9	8,9,10,11,12,13,14,17,19mm
	x1	250mm
	x1	300g
	x1	250mm
	x1	200mm



Bandeja superior removível

Recipiente para  
ferramentas maiores

3 MÓDULOS INDEPENDENTES  
EQUIPADOS COM:

**1** CAIXA DE FERRAMENTAS EM MÓDULOS  
EVA + BANDEJA SUPERIOR REMOVÍVEL

**2** 2 GAVETAS COM FERRAMENTAS EM  
MÓDULOS EVA

**3**

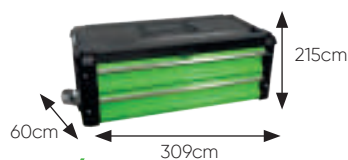

IVA não incluído

**JBM** / [www.jbmcamp.com](http://www.jbmcamp.com)

83

EQUIPAMENTO DE OFICINA

# CAIXA DE FERRAMENTAS DE FERRO - 64 PEÇAS

53565 258,00€



CrV 64 PCS



CINCADO



CONTÉM

	PH1x100mm, PH2x150mm, PH3x200mm	x3
	SL5x100mm, SL6x150mm, SL8x200mm	x3
	250mm	x1
	180mm	x1
	200mm	x1
	180mm	x1
	1/2" x18	10, 11, 12, 13, 14, 15, 16, 17, 18, 19, 20, 21, 22, 23, 24, 27, 30, 32mm
	1/2" x1	255mm
	1/2" x1	21mm
	1/2" x1	457mm
	1/2" x1	6, 7, 8, 9, 10, 11, 12, 13, 14, 15, 16, 17, 18, 19, 20, 21, 22, 24mm
	1/2" x3	76, 127, 254mm
	1/2" x9	15, 2, 2.5, 3, 4, 5, 6, 8, 10mm



REPOSIÇÕES DISPONÍVEL

## CAIXA DE FERRAMENTAS COM 5 COMPARTIMENTOS

51574 52,00€

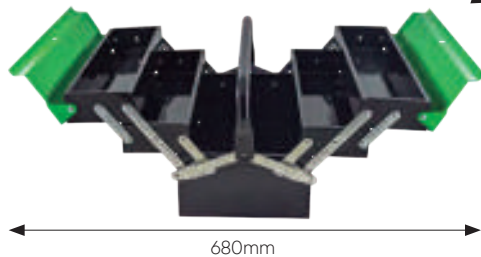

## CAIXA DE FERRAMENTAS XL

53222 57,00€



XL

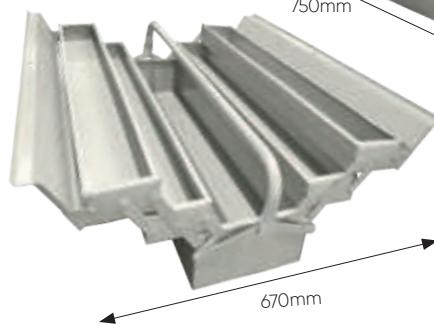
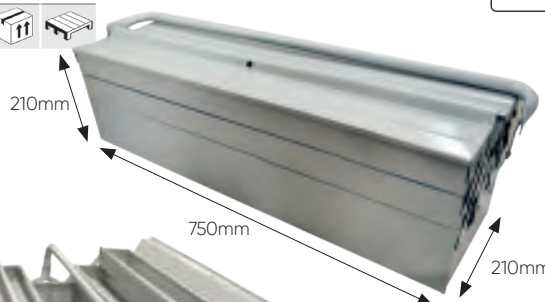

## CAIXA DE FERRAMENTAS COM 3 GAVETAS FRONTAIS + COMPARTIMENTO SUPERIOR

51600 109,00€



MEDIDAS GAVETA INTERIOR

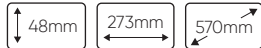

COM ASA



## CAIXA DE FERRAMENTAS COM 6 GAVETAS + COMPARTIMENTO SUPERIOR

51575 317,00€



- Gavetas grossas: 570mm ancho  
- Gavetas Meninhas: 180mm ancho

SEM ASA

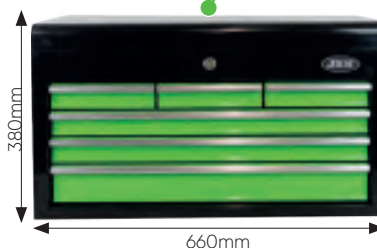



## BANCO HIDRÁULICO

**50843** 79,00€

5,61 - 1 48  
Kg SUB

520mm

↑520mm  
↓390mm



## BANCO DE AÇO

**50844** 65,00€

3,50 - 1 60  
Kg SUB

100 KG



## ESTRADO MECÂNICO PLÁSTICO

**52148** 82,00€

6,00 - 1 20  
Kg SUB

- Plástico alta densidade.  
- Muito resistente.

150KG



RODAS PARA REF. 52148

**11971** 3,10€

0,20 50 -  
Kg SUB

## ESTRADO DE MECÂNICO ALMOFADADO DOBRÁVEL

**50808** 77,00€

5,63 - 1 28  
Kg SUB

150KG



## ESTRADO MECÂNICO ALMOFADADO DOBRÁVEL

**53211** 75,00€

5,40 - 1 38  
Kg SUB

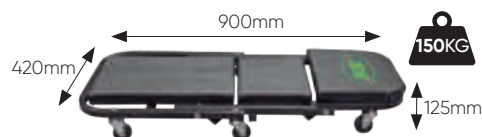

**52542** 109,00€

12,70 - 1 19  
Kg SUB

AÇO E  
ASSENTOS PVC

7 RODAS



## TORNO DE BANCADA ABERTURA RÁPIDA BASE ROTATIVA

**52871** 248,00€

24,50 - 1 28

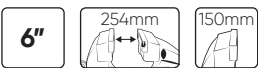

ABERTURA  
INMEDIATA  
+ PARAFUSO  
ROTATIVO



## TORNO DE BANCADA BASE ROTATIVA

**53031** 59,00€

5,70 - 1 128

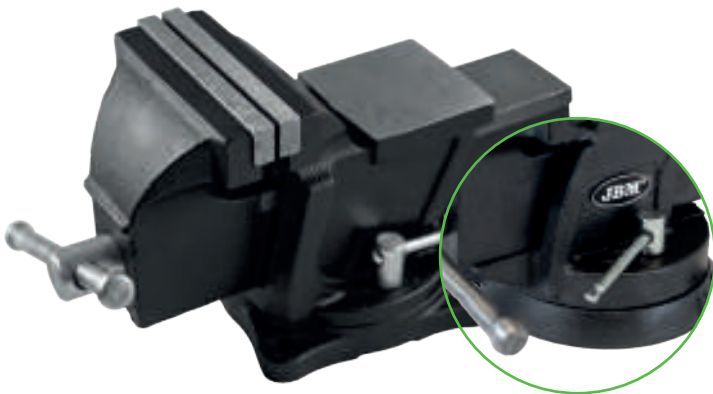
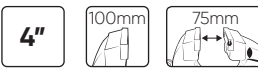

**53032** 126,00€

13,71 - 1 60

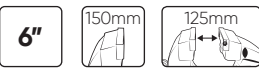

## TORNO DE BANCADA

**52869** 52,00€

4,15 - 4 192



**52870** 100,00€

12,15 - 1 72



## BIGORNAS PROFISSIONAIS

**52308** 440,00€

47,00 - 1 24



**52309** 941,00€

100,00 - 1 8



AÇO





## **FERRAMENTA A BATERIAS MOTOR BRUSHLESS**

- 88 CHAVES DE IMPACTO
- 91 CATRACA / CHAVE DE FENDA
- 92 BERBEQUIM DE IMPACTO
- 94 POLIDOR
- 95 SERRAS
- 98 MULTIFERRAMENTA OSCILANTE
- 99 PISTOLAS
- 101 ASPIRADOR/COMPRESSOR
- 102 ILUMINAÇÃO LED
- 103 JARDINAGEM
- 107 ARMAZENAMENTO
- 108 BATERIAS / CARREGADORES
- 109 ACESSÓRIOS / CONSUMÍVEIS

# Ferramenta elétrica sem fio, maior conforto e movimentação ilimitada

Com motor **BRUSHLESS**: maior eficiência, vida útil mais longa, mais velocidade e menos ruído.

CE RoHS TÜV GS

## CHAVE DE IMPACTO COM MOTOR BRUSHLESS 1/2"

1000Nm

60018 306,00€

3.10 - 4 120  
Kg SUB if

Bateria não incluída.

Esta ferramenta destina-se a **aparafusar/desaparafusar** elementos de **fixação**.



**BRUSHLESS MOTOR** 20V 1000 Nm 1/2" 0-2300IPM

① 0-900 RPM ② 0-1600 RPM ③ 0-1900 RPM

**LED**

EIXO DE SAÍDA

14675 17,00€

COBERTURA

14677 9,00€

PLACA DE CIRCUITO IMPRESSO + ESTATOR

14679 9,50€

14648 106,00€

BLOCO DE CHOQUE

14676 36,50€

PLACA DE CIRCUITO IMPRESSO

14678 86,00€

ROTOR

14769 37,75€

5 ENGRENAGENS DIFERENTES



Você quer ver como funciona?



- Ele inclui:  
Alça.  
Interruptor do sentido de rotação para frente/para trás.  
Gatilho.  
Iluminação de fundo LED.  
Gancho para cinto





## CHAVE DE IMPACTO COM MOTOR BRUSHLESS 1/2"

**1200Nm**

**60044** 478,00€

3.20	-	5	144
Kg	Sub	ff	

Bateria não incluída.

Esta ferramenta destina-se a **aparafusar/desaparafusar** elementos de **fixação**.



**BRUSHLESS MOTOR**

**20V** **1200 Nm** **1/2"**

0-1000 RPM 0-1350 RPM 0-1600 RPM

0-1000IPM 0-1600IPM 0-2000IPM

EIXO DE SAÍDA

**16151** 50,00€

**16152** 25,10€

COBERTURA

**16153** 81,00€

PLACA DE CIRCUITO IMPRESSO + ESTATOR

**16154** 34,10€

BLOCO DE CHOQUE

**16155** 34,10€

PLACA DE CIRCUITO IMPRESSO

**16156** 12,60€

ROTOR

**16157** 59,00€

5 ENGRENAGENS DIFERENTES

LED



## PISTOLA DE IMPACTO DE 1/2" A BATERIA COM CAIXA

**60044C** 652,00€

3.20	-	4	-
Kg	Sub	ff	

CARREGADOR 20V - 4A

**60016** 49,00€

0.80	-	5	210
Kg	Sub	ff	

4,0 Ah BATERIA DE LÍTIO

**60013** 80,00€

0.75	-	5	700
Kg	Sub	ff	



Use-os com baterias JBM: uma única bateria adequada para todas as ferramentas

BATERIA DE LÍTIO

2.0Ah



**60012**

4.0Ah



**60013**

6.0Ah



**60015**

CARREGADOR



4A **60016**



CARREGADOR RÁPIDO 6A **60017**





# APARAFUSADOR DE IMPACTO BRUSHLESS

**60005** 132,00€

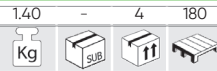

Bateria não incluída.

Esta ferramenta foi projetada para **apertar rapidamente parafusos e porcas** e é especialmente útil ao trabalhar com **parafusos longos e materiais duros**.

O driver está equipado com **iluminação LED** da área de trabalho para um trabalho mais confortável e preciso, um **mandril de troca rápida hexagonal de 1/4"** de polegada para rápida instalação e remoção do bico, além de um **gatilho com uma função de trava** para impedir o início acidental da ferramenta.

- Contém:
- 1 pc gancho de cinto.
- Iluminação de fundo LED integrada.
- Controlador de velocidade.
- Alça suave.
- Redutor de engrenagens de metal.



**BRUSHLESS MOTOR** 20V 200 Nm LED 0-2800 RPM 1/4"



BLOCO DE CHOQUE

**14637** 15,50€

EIXO T

**14638** 7,00€

INTERRUPTOR

**14640** 8,00€

PLACA DE CIRCUITO IMPRESSO

**14642** 83,00€

PLACA DE CIRCUITO IMPRESSO + ESTATOR

**14765** 97,00€

COBERTURA

**15254** 12,50€

ROTOR

**14641** 18,50€

## CONSUMÍVEIS

**53857**



**53858**



página 111

## Use-os com baterias JBM: uma única bateria adequada para todas as ferramentas

### BATERIA DE LÍTIO

2.0Ah



**60012**

4.0Ah



**60013**

6.0Ah



**60015**

### CARREGADOR



4A

**60016**



### CARREGADOR RÁPIDO

6A

**60017**

# ROQUETE ELÉCTRICO DE 1/2" BRUSHLESS

**60024** 190,00€

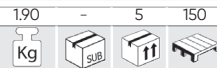

ESTA REFERÊNCIA INCLUI X1 BATERIA E X1 CARREGADOR

Esta ferramenta foi projetada para **apertar/desapertar os prendedores em locais de difícil acesso**.

**BRUSHLESS MOTOR** 12V 80 Nm 1/2" 0-175 RPM LED 2.0AH 60min +/-10min



INCLUI:

CARREGADOR DE 12 V PARA REF. 60026

**60025** 31,60€

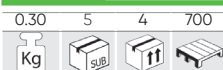

BATERIA DE ÍON DE LÍTIO 2.0 A\*h SAMSUNG PARA REF. 60024

**60026** 37,90€



# BERBEQUIM PERCUTOR COM MOTOR BRUSHLESS 2 VELOCIDADES

**60006** 182,00€

2.50	-	4	68
Kg	Sub	ff	ff

Bateria não incluída.

Esta ferramenta foi projetada para perfurar madeira e metal, operações de perfuração principalmente em **alvenaria, concreto, pedra e tijolo vermelho**, bem como para **apertar/desapertar e desaparafusar parafusos e porcas**.

A ferramenta possui um sistema para selecionar o modo de operação (furadeira, furadeira de impacto ou parafusadeira), sistema que permite escolher entre 23 níveis de apertos e velocidades diferentes e um porta-brocas de 1/2", sem chave para facilitar a instalação/remoção das mesmas



- Contém:  
1 pç. alça adicional.  
1 pç. gancho de cinto.  
23 ajustes de torque de aperto.  
Iluminação de fundo LED integrada.  
Interruptor de 2 velocidades.  
Alça suave.

## CARTUCHO DE FURO

**14643** 24,50€

## TROCAR

**14644** 8,00€

## ROTOR

**14645** 45,00€

## PLACA DE CIRCUITO IMPRESSO + ESTATOR

**14646** 110,00€

## PEGA ADICIONAL

**14954** 14,50€

**BRUSHLESS MOTOR**

**20V** 80 Nm **1/2"** 29750IPM

1 2

0-500 RPM 0-1750 RPM

**LED**

DIÂMETRO DO MANDRIL: 2-13MM (1/2")



ALÇA ADICIONAL



## CONSUMÍVEIS

página 109-111

### KIT DE BROCAS PARA CONCRETO

**53861**



3-10MM

**8** PCS

**53860**



4-10MM

**5** PCS

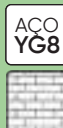

### KIT DE BROCAS ESPIRAIS HSS 4341

**53852**



1-10MM

**170** PCS

**53856**



1-13MM

**25** PCS

### KIT S2 DE BOCAS DE MUDANÇA RÁPIDA REVESTIMENTO PRETO

**53857**



**49** PCS

**53858**



**21** PCS

### CONJUNTO DE SERRAS ANULARES BIMETÁLICAS

**53859**



**8** PCS

HSS M42

4-6TPI

# REBARBADORA ÂNGULAR BRUSHLESS

Diâmetro do disco: 115 mm (4-1/2")

Diâmetro do disco: 125 mm

**60008** 141,00€

1.85	-	4	156
Kg	Sub	ff	ff

**60028** 142,00€

1.95	-	4	144
Kg	Sub	ff	ff

- A esmerilhadeira foi projetada para **esmerilar, limpar e cortar vários materiais**.  
- Tamanho da rosca: **M14**.

Bateria não incluída.  
Lâmina não incluída.

**BRUSHLESS MOTOR**

**20V** 8000 RPM **M14**

- Contém:  
1 pç Tampa do rebolo.  
1 pç Alça adicional.  
1 pç Chave.



## ROTOR

**14652** 47,00€

## INTERRUPTOR

**14653** 5,25€

## PLACA DE CIRCUITO IMPRESSO + ESTATOR

**14654** 104,00€

## ENGRENAGEM #13

**14655** 5,95€

## PLACA DE FIXAÇÃO

**14656** 4,50€

## ENGRENAGEM #23

**14657** 4,50€

## ENGRENAGEM #22

**14766** 3,15€

## ENGRENAGEM #29

**14767** 2,34€

## PEGA ADICIONAL

**14956** 4,40€

## CAIXA DE PROTEÇÃO 115MM

**14957** 4,10€

## CAIXA DE PROTEÇÃO 125MM

**14808** 3,05€

## PORCA DE REMOÇÃO RÁPIDA M14

**15014** 20,00€



## CONSUMÍVEIS

página 112

### CÍRCULO DE CORTE / CÍRCULO DE CORTE EM AÇO INOX

**14893**

T42



**14900**

T41



### PORCA DE REMOÇÃO RÁPIDA M14 PARA REBARBADORA

**15014**





# MARTELO PERCUTOR BRUSHLESS

**60023** 212,00€

3.10 - 6 120



Bateria não incluída.

Ferramenta desenhada para realizar tarefas de cinzelar e perfurar com impacto em concretos e tijolos

- Tipo de mandril: **SDS**.



**BRUSHLESS MOTOR**

**20V** 4750BPM 2.2 J 1350 RPM

28mm 22mm 13mm

**SDS**

- Contém:  
1 pç. tampa protetora contra poeira.  
1 pç. medidor de profundidade.  
1 pç. alça adicional.  
1 pç. cinzel pontiagudo.  
1 pç. cinzel plano.  
Brocas SDS: Ø8/10/12 x 150 mm.



ALAVANCA DE POTÊNCIA <b>14693</b> 3,50€	ANEL DE VEDAÇÃO <b>14698</b> 1,00€	TAMPA DE PÓ <b>14967</b> 5,50€
ROLAMENTO DA ALAVANCA DE PÊNDULO <b>14694</b> 11,50€	ROTOR <b>14699</b> 30,00€	MEDIDOR DE PROFUNDIDADE <b>14968</b> 6,00€
MARTELO DE CHOQUE <b>14695</b> 4,00€	ENGRENAGEM No. 61 <b>14700</b> 2,50€	
CILINDRO PNEUMÁTICO <b>14696</b> 18,00€	PLACA DE CIRCUITO IMPRESSO <b>14702</b> 92,00€	
INTERRUPTOR <b>14697</b> 8,00€	ENGRENAGEM No. 67 <b>14701</b> 2,50€	

## CONSUMÍVEIS

página 109

<b>14837</b> FORMÃO DE FINO AFIADO SDS-PLUS 14 X 250 MM	<b>14839</b> FORMÃO DE FINO PLANO SDS-PLUS 40 X 250 MM	<b>14841</b> ADAPTADOR SDS-PLUS PARA CARTUCHO DE PERFURAÇÃO DE 1/2"	<b>14842</b> CARTUCHO DE PERFURAÇÃO DE MUDANÇA RÁPIDA 2-13 MM 1/2" -20 UNF	<b>53850</b> KIT DE BROCAS DO PERFURADOR COM A HASTE SDS-PLUS
<b>14838</b> FORMÃO DE FINO PLANO SDS-PLUS 20X250 MM	<b>14840</b> FORMÃO DE SULCO SDS-PLUS 250 MM			

# LIXADORA BRUSHLESS

**60033** 104,00€

13.50 - 4 144



Bateria não incluída.

Esta ferramenta foi projetada para **lixar madeira, ferro, plástico e materiais semelhantes**, usando lixa adequada. Esta lixadora foi projetada com três velocidades, uma alça confortável e um saco de pó embutido.



**20V**

6000 RPM  
8000 RPM  
10000 RPM

0°C  
45°C

x3 SPEED  
150mm

SACO DE PÓ <b>15530</b> 7,50€	ROLAMENTO <b>15533</b> 4,50€	ROLAMENTO <b>15536</b> 14,50€
SUPOORTE DE SACO DE VACUO <b>15531</b> 5,00€	ROLAMENTO <b>15534</b> 4,50€	UNIDADE DE FREIO DE BORRACHA <b>15537</b> 6,00€
ESTATOR + PP + SENSOR <b>15532</b> 98,00€	SELA DE ROLAMENTO <b>15535</b> 3,50€	PLACA DE BASE <b>15538</b> 17,00€

Use-os com baterias JBM: uma única bateria adequada para todas as ferramentas

### BATERIA DE LITIO

2.0Ah **60012** 4.0Ah **60013** 6.0Ah **60015**

### CARREGADOR

4A **60016** 6A **60017** CARREGADOR RÁPIDO

## POLIDOR COM MOTOR BRUSHLESS

60009 168,00€

2.65	-	4	80
Kg	sub	ff	

Bateria não incluída.

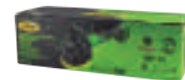

A ferramenta foi projetada para um acabamento to limpo, como **polir e arredondar cantos e arestas**, além de obter **superfícies lisas** com um disco e uma almofada de polimento.

O dispositivo possui um interruptor de **9 velocidades**, além de um **gatilho com uma função de travamento** durante a operação ou travamento durante o armazenamento para impedir a partida acidental.

- Contém:

- 1 pç. alça adicional em forma de D.
- 1 pç. chave sextavada.
- 1 pç. almofada de polimento.
- Interruptor de 9 velocidades: 800, 1000, 1200, 1400, 1600, 1800, 2000, 2200, 2400 rpm.
- Alça suave.
- Interruptor de segurança.
- Botão de bloqueio do eixo.



**BRUSHLESS MOTOR**

20V

800-2400 RPM

M14

VELOCIDADE AJUSTÁVEL



Ø 180mm

ROTOR

14658 45,00€

PLACA DE CIRCUITO IMPRESSO + ESTATOR

14660 83,00€

ENGENHAGEM #24

14662 2,50€

RODA DE POLIMENTO

14958 22,00€

INTERRUPTOR

14659 5,00€

ENGENHAGEM

14661 9,00€

ENGENHAGEM #26

14663 2,50€

ALÇA EM D ADICIONAL

14959 10,00€



## PLAINA BRUSHLESS

60020 175,00€

3.15	-	4	72
Kg	sub	ff	

Bateria não incluída.

Esta ferramenta foi projetada para **trabalhar com madeira**. Permite obter uma **superfície lisa da madeira e fazer uma forma cônica**, se necessário.

A plaina é equipada com uma **base de liga de alumínio** para posicionamento preciso, um **sistema de coleta de poeira** para coletar poeira do processamento de madeira e um **botão de trava de gatilho** para impedir o início acidental da ferramenta.

- Contém:

- 1 pç. botão de ajuste da profundidade de chanframento.
- 1 pç. guia paralelo.
- 3 pç. botões de ajuste.
- 1 pç. chave.



**BRUSHLESS MOTOR**

20V



10000 RPM

10,5mm

82mm  
Ø 2mm

- Características:

- Botão de ajuste de profundidade de amostragem
- Base de liga de alumínio
- Botão de bloqueio do botão de início
- Sistema de coleta de poeira
- Alça suave

ESTATOR

14936 27,50€

CINTO

14684 3,00€

GUIA DE ENCAIXE

14964 8,00€

INTERRUPTOR

14685 5,00€

GUIA PARALELO

14965 8,50€

PLACA DE CIRCUITO IMPRESSO

14686 73,00€

ROTOR

14687 35,00€





## SERRA SABRE COM MOTOR BRUSHLESS

60019 178,00€

3,45 - 4 112



Bateria não incluída.

Esta ferramenta foi projetada para **cortar uma grande variedade de materiais e é amplamente utilizada**. O design permite a **substituição rápida e conveniente da lâmina de serra** devido ao suporte de aperto rápido e é caracterizado por uma velocidade de corte ajustável, dependendo da operação a ser executada.



- Contém:  
1 pç. lâmina de madeira.  
1 pç. lâmina de metal.

BOTÃO  
14680 17,00€

PLACA DE CIRCUITO IMPRESSO  
14683 86,00€

PLACA DE CIRCUITO IMPRESSO + ESTATOR  
14681 108,00€

ROTOR  
14770 40,00€

INTERRUPTOR  
14682 9,00€

CONSUMÍVEIS PARA REF. 60019

página 112

14995

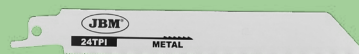

14994



CONSUMÍVEIS PARA REF. 60010

página 112

14993



14991



## SERRA TICO-TICO BRUSHLESS

60010 170,00€

2,80 - 4 144



Bateria não incluída.

Esta ferramenta foi projetada para **serrar tais materiais como madeira, aço, plástico e metal**. A serra de vaivém está equipada com um **mecanismo pendular de 4 posições**: 3 posições para corte orbital e 1 posição para corte direto, o que permite escolher a velocidade de corte ideal da lâmina para a dureza do material



20V

1 Max: 135mm  
1 Max: 8.1mm



2600 SPM LED

PLACA DE CIRCUITO IMPRESSO + ESTATOR

14664 100,00€

INTERRUPTOR

14665 8,80€

PLACA DE CIRCUITO IMPRESSO

14666 97,00€

ENGRENAGEM

14667 8,80€

BOTÃO

14668 7,70€

COMPONENTES DO ROLO

14670 4,50€

ROTOR

14768 28,80€

TUBO DE PÓ

14960 3,85€

GUIA PARALELO

14961 3,95€

- Contém:  
1 pç: disco de madeira.  
1 pç: Guia de borda.  
1 pç: tubo de poeira.

- Características:  
Engrenagem com engrenagens de metal.  
Alça suave.  
Controle de velocidade.  
Mecanismo pendular de 4 posições.  
Base de alumínio.  
Iluminação LED integrada.  
Botão de bloqueio do gatilho.

Use-os com baterias JBM: uma única bateria adequada para todas as ferramentas

BATERIA DE LITIO

2.0Ah



60012

4.0Ah



60013

6.0Ah



60015

CARREGADOR



4A  
60016



CARREGADOR RÁPIDO  
6A  
60017

# SERRA CIRCULAR COM MOTOR BRUSHLESS

**60011** 175,00€

2,55 - 4 128



Bateria não incluída.

Esta ferramenta foi projetada para **serrar madeira**. A serra circular com um diâmetro de **115 mm com 24 dentes** é ideal para **cortes longitudinais/transversais** diretos e para serrar até **45°** de tábuas e painéis de madeira. A serra também possui um **botão de trava de gatilho** para impedir o arranque acidental da ferramenta e uma **cobertura de alumínio**.



- Contém:  
1 pc: disco TCT de 115mm 24T.  
1 pc.: Guia para borda.  
1 pc.: tubo de poeira.  
1 pc: chave Allen.

- Características:  
Mecanismo de bloqueio.  
Alça suave.  
Caixa superior e inferior de alumínio.  
Sistema de coleta de poeira.

**BRUSHLESS MOTOR**

**20V** **AL** **4000 RPM**

90° 45°

115mm 10mm

ROTOR

**14671** 44,00€

PLACA DE CIRCUITO IMPRESSO + ESTATOR

**14674** 73,00€

GUIA PARALELO

**14963** 7,50€

INTERRUPTOR

**14672** 5,00€

TUBO DE PÓ

**14962** 6,50€



CONSUMÍVEIS PARA REF. 60011

página 112

Serra circular 24 dentes 115mm

**14989** **14986**



CONSUMÍVEIS PARA REF. 60007

página 112

Serra circular 24 dentes 165mm

**14988** **14985**



# SERRA CIRCULAR COM MOTOR BRUSHLESS

**60007** 170,00€

Bateria não incluída.

3,75 - 4 60



Esta ferramenta foi projetada para **serrar madeira**. Uma serra circular de **165mm de diâmetro e 24 dentes** é ideal para **cortes longitudinais/transversais retos**, bem como para serrar tábuas e painéis de madeira num **ângulo de até 45°**.

- Características:  
Mecanismo de bloqueio.  
Alça suave.  
Caixa superior e inferior de alumínio.  
Iluminação de LED embutida.



**BRUSHLESS MOTOR**

**20V** **AL** **4500 RPM**

165mm 20mm

**LED**

INTERRUPTOR

**14647** 3,00€

ENGRENAGEM

**14650** 5,00€

GUIA PARALELO

**14955** 7,50€

ROTOR

**14649** 50,00€

PLACA DE CIRCUITO IMPRESSO + ESTATOR

**14651** 86,00€

- Contém:  
1 pc: disco TCT de 165 mm 24T.  
1 pc.: Guia para borda.  
1 pc: chave Allen.







## SERRA DE ESQUADRIA MOTOR BRUSHLESS

**60022** 470,00€



Bateria não incluída.

Esta ferramenta foi projetada para **serrar madeira e materiais similares**. A ferramenta permite executar cortes oblíquos quando é necessário um corte inclinado ao longo da superfície da peça de trabalho, cortes num ângulo usados, como regra, para conexões que formam um ângulo de 90°, bem como cortes combinados quando é necessário um corte angular e um corte ao longo da borda e da superfície frontal da peça de trabalho.

A serra esquadria está equipada com um **saco de pó**, um **apontador laser**, uma **chave** para remover / instalar a lâmina e um **torno para prender a peça de trabalho**. Além disso, por razões de segurança, é fornecido um **bloqueio do botão** de início para impedir o início acidental da ferramenta.



20V

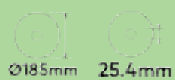
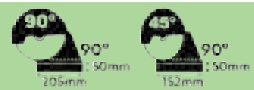

- MOTOR  
**14691** 167,00€
- INTERRUPTOR  
**14692** 5,50€
- SACO DE PÓ  
**14966** 7,50€



Contém:  
1 pç. serra circular de 40 dentes  
1 pç. braçadeira  
1 pç. chave de lâmina  
1 pç. saco de pó



CONSUMÍVEIS PARA REF. 60022

página 112

Serra circular 40 dentes 185mm

**14990** **14987**



- Material: lâminas YG8, base de carboneto de tungstênio.



Use-os com baterias JBM: uma única bateria adequada para todas as ferramentas

BATERIA DE LITIO

2.0Ah



**60012**

4.0Ah



**60013**

6.0Ah



**60015**

CARREGADOR



**4A**  
**60016**



**CARREGADOR RÁPIDO**  
**6A**  
**60017**



## MULTIFERRAMENTA

**60041** 77,00€

1.60 - 4 216



Bateria não incluída.



ALAVANCA DE BLOQUEIO

**15320** 1,00€

ROLAMENTO DE BOLA 625

**15321** 3,00€

REGULADOR DE VELOCIDADE

**15324** 18,00€

PAINEL DE JUNÇÃO

**15325** 3,50€

TAMPA DO MEIO

**15322** 3,50€

MOTOR

**15323** 24,00€

JUNTA DE VEDAÇÃO

**15326** 1,00€

MANGA AUXILIAR

**15327** 5,50€



**20V**  
BRUSHLESS MOTOR



Uma variedade de acessórios pode ser usada com a ferramenta oscilante multifuncional para se adequar a uma ampla variedade de tarefas. A ferramenta é especialmente útil para limpeza, lixamento e serragem profunda em espaços apertados.

## CONSUMÍVEI

página 111

**53999**

**54000**

**54002**

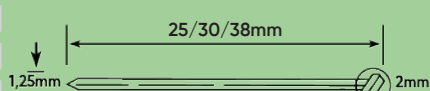

**54008**

**54010**

**54011**

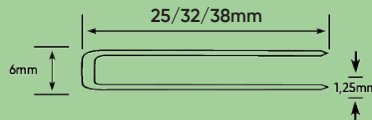

## GRAMPEADOR ELÉTRICO

**60037** 222,00€

3.60 - 4 128



Bateria não incluída.

**20V 2000Ah**

MAX 100 grapas por minuto

50 grapas por minuto

Capacidade máxima de grapas

**100**



A ferramenta é projetada para **grampear** papelão, materiais isolantes, tecido, folha, couro e **materiais semelhantes à madeira** ou outras superfícies semelhantes por meio de um martelo de alta potência usando ar comprimido.

A ferramenta é equipada com iluminação LED para indicar o status e melhorar a visibilidade durante a operação, um botão seletor de acionamento para selecionar entre os modos de acionamento único e de contato para uma operação mais precisa ou mais rápida, e uma roda de ajuste de profundidade para selecionar a profundidade desejada de

pregos/grampas. Além disso, a ferramenta é equipada com um gancho para cinto e uma alça acolchoada.

Além disso, a ferramenta é equipada com um **pino de contato de segurança**, que deve ser pressionado contra a peça de trabalho antes que o prego/grampo seja puxado no modo de acionamento único, ou seja, o pino atua como um mecanismo de segurança para evitar o início acidental da ferramenta.



Máx. comprimento de prego	50 mm
pregos sem tampa de tamanho 18	
Largura máxima da secção transversal do prego	1.25 mm
Espessura máxima da secção transversal do prego	1.05 mm

Longitud máxima de las grapas	40 mm
grampos do tipo leve com parte superior estreito de tamanho 18	
Largura máxima da secção transversal dos agrafos	1.2 mm
Espessura máxima da secção transversal dos agrafos	1 mm
Máx. tamanho da parte superior do grampo	6 mm

MARTELO EM CONJUNTO

**15276** 46,00€

TAMPA DE VEDAÇÃO EM CONJUNTO

**15277** 9,00€

CARCAÇA DE SEGURANÇA

**15278** 3,50€

MOTOR

**15279** 69,00€

CHAVE

**15280** 91,00€

Use-os com baterias JBM: uma única bateria adequada para todas as ferramentas

BATERIA DE LITIO

2.0Ah



**60012**

4.0Ah



**60013**

6.0Ah



**60015**

CARREGADOR



**4A**  
**60016**



**CARREGADOR RÁPIDO**  
**6A**  
**60017**



## PISTOLA DE GRAXA PNEUMÁTICA ELLÉTRICA

**60038** 255,00€

Bateria não incluída.

3,90	-	4	32
Kg	sub	ff	

Esta ferramenta é uma **pistola de graxa**. Alimentada por bateria, a ferramenta é fácil de usar e transportar.

A ferramenta é equipada com iluminação LED para melhor visibilidade da área de trabalho, válvula de segurança de saída de ar para proteção contra sobrepessão e entupimento, alça macia para fácil operação e botão de bloqueio para evitar ativação acidental. O fluxo de graxa é regulado por meio da roda de controle de velocidade (**8 posições**).



<b>20V</b>	<b>9000PSI</b> 620BAR	<b>200g/min</b>	<b>420g</b>	<b>600g</b>	<b>NLGI #2</b>	<b>760mm</b>	<b>8</b>
	Volume de fluxo volume flow rate	Capacidade de graxa em cartucho Grease cartridge capacity	Capacidade de graxa a granel Bulk grease capacity	Tipos de graxa Grease types			Níveis de velocidade flow lever



BOMBA

**15380** 169,00€

PLACA DE CIRCUITO IMPRESSO

**15382** 42,00€

MICRO GATILHO

**15381** 5,50€

MANGUEIRA FLEXÍVEL

**15440** 33,00€

## PISTOLA PARA SILICONE A BATERIA

**60032** 123,00€

Bateria não incluída.

1,95	-	4	80
Kg	sub	ff	

Esta ferramenta foi projetada para **preencher qualquer fenda ou rachadura numa ampla variedade de materiais**, como metal, vidro, madeira e cerâmica. A ferramenta é equipada com **luz de trabalho LED** para fácil operação em condições de baixa visibilidade, além de **controle de velocidade** e sistema de **trava de gatilho**. Além disso, o design inclui um mecanismo de **proteção contra quedas**. Depois de liberar o gatilho 0,2-0,3 s, a cola continua a fluir por 0,8 s.



<b>20V</b>	<b>2500 Nm</b>	<b>LED</b>	<b>VELOCIDADE AJUSTÁVEL</b>	<b>MECANISMO ANTIGOTEO ANTI-DROP MECHANISM</b>
<b>300ml</b>	<b>0,5-8mm/s</b>			



MOTOR

**15126** 19,50€

PLACA DE CIRCUITO IMPRESSO

**15127** 29,00€

Use-os com baterias JBM: uma única bateria adequada para todas as ferramentas

BATERIA DE LÍTIO

2.0Ah



**60012**

4.0Ah



**60013**

6.0Ah



**60015**

CARREGADOR



**4A**  
**60016**



**6A**  
**60017**

## PISTOLA DE AR QUENTE A BATERIA

60042 106,00€

1.00 - 4 240



Bateria não incluída.



A pistola de ar quente elétrica se utiliza principalmente para a retração de PVC, soldar, dobragem de peças de plástico, secado em geral, furação e descongelamento.

MOTOR

15719 11,00€

ELEMENTO DE AQUECIMENTO

15720 59,00€

PLACA DE CIRCUITO

15721 46,00€

20V

15A

550°C  
1022°F

Max.  
200L/min.

0.6kg

Ø 34mm

PA6-GF30+TPE



## PISTOLA DE PINTURA SEM FIO

60043 123,00€

1.70 - 3 90



Bateria não incluída.

Esta ferramenta foi projetada para pulverizar tinta em ambientes fechados e ao ar livre.

BICO DE PULVERIZAÇÃO

15722 4,25€

VÁLVULA

15723 2,21€

ARRUELA DE VEDAÇÃO

15724 2,82€

ANILHA

15725 1,86€

ARRUELA DE VEDAÇÃO

15726 2,82€

TANQUE DE TINTA

16150 7,90€

1,3 kg 900ML 20V 280W

20m

2,5mm

60 DIN

700ml/min PA6 y PP



O bico pode ser ajustado para um dos três modos de pulverização: circular, horizontal ou vertical.



Use-os com baterias JBM: uma única bateria adequada para todas as ferramentas

BATERIA DE LITIO

2.0Ah



60012

4.0Ah



60013

6.0Ah



60015

CARREGADOR



4A  
60016



CARREGADOR RÁPIDO  
6A  
60017



## ASPIRADOR PORTÁTIL SEM FIO

60001 88,00€

1.70	-	4	64
Kg	sub	ff	

Bateria não incluída.

Este aspirador elétrico **sem fio** foi projetado para aspirar qualquer material que não seja prejudicial à saúde.

A **bateria recarregável** torna-o **facilmente portátil** e os diferentes acessórios permitem realizar diferentes tipos de limpeza em vários locais.



- Contém:  
1 Bocal de fenda.  
1 Tubo de extensão.  
1 Bocal de escova.  
1 Bocal de chão.



20V

3.8 κPa 500ml

ELEMENTO DE FILTRO

14628 2,50€

INTERRUPTOR

14629 4,00€

MOTOR

14630 22,00€

TUBO DE EXTENSÃO

14950 6,50€

BOCAL DE FENDA

14951 9,50€

FILTRO COM CAIXA PARA ASPIRADOR PORTÁTIL  
15765 14,00€

BOCAL DE CHÃO

14952 19,00€

ESCOVA

14953 8,50€

## COMPRESSOR DE AR A BATERIA

60003 110,00€

1.85	-	4	100
Kg	sub	ff	

Bateria não incluída.

Este compressor permite inflar rodas de carros e motos, bolas, lanchas infláveis, colchões infláveis, etc.

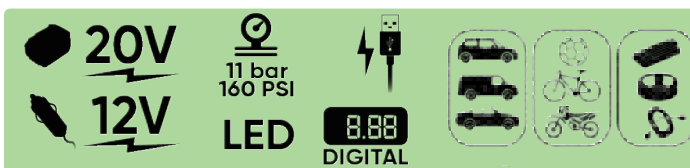

- Ele inclui:



MÓDULO DE BOMBA

14634 36,50€

VENTILADOR

14635 10,00€

INTERRUPTOR DO MODO DE OPERAÇÃO

14631 3,50€

INTERRUPTOR DE LUZ LED

14632 3,50€

MANGA DE ALTA PRESSÃO

15151 10,50€



12L/MIN



380L/MIN

Comprimento da mangueira de alta pressão: 760 mm  
Comprimento da mangueira de alta capacidade: 460 mm



Use-os com baterias JBM: uma única bateria adequada para todas as ferramentas

BATERIA DE LITIO

2.0Ah



60012

4.0Ah



60013

6.0Ah



60015

CARREGADOR



4A  
60016



CARREGADOR RÁPIDO  
6A  
60017

## FOCO DE ILUMINAÇÃO LED

60004 79,00€

1,45	-	4	96
Kg	SUB	↑↑	↑↑↑

Bateria não incluída.

Esta lâmpada LED de operação foi projetada para **criar a iluminação necessária** na área de trabalho e em outros locais. É alimentada por uma bateria de íon de lítio portátil, que torna o dispositivo portátil e **ideal para qualquer local de trabalho e situações em que o acesso à rede elétrica seja limitado**. Quando a bateria está descarregada, a lâmpada pode ser conectada a uma rede com uma tensão de 230 V usando um **cabo de rede** localizado na parte traseira do dispositivo.

- Ele inclui:  
Cabo.



1,5m



20V 2400 LED LM

INTERRUPTOR

14636 30,00€

TRIPODE PARA FAROL DE TRABALHO LED (REF. 60004)

15049 37,40€

2,10	-	4	120
Kg	SUB	↑↑	↑↑↑

↑1200mm  
↓595mm



280mm

325mm

275mm

1200mm

AJUSTE DE 360°



## LÂMPADA DE TRABALHO PORTÁTIL LED

60035 30,00€

0,40	-	5	475
Kg	SUB	↑↑	↑↑↑

Bateria não incluída.

Esta lâmpada de trabalho LED é projetada para **fornecer a iluminação necessária na área de trabalho e em outros locais**. É alimentada por uma bateria portátil de íon de lítio, tornando-a portátil e ideal para todos os locais de trabalho e situações onde a energia elétrica é limitada.

O difusor da lâmpada LED fornece um fluxo luminoso de **500 e 1000 lumens**, e o **mecanismo giratório da lâmpada (90°)** permite ajustar o ângulo desejado. Também está incluída uma alça macia para um manuseio mais confortável e um gancho de suspensão para prender a outro objeto.



20V 10W



500 Lm



1000 Lm

90°

220-240V 50Hz

Parpadeante Flashing



PLACA DE CIRCUITO IMPRESSO

15124 9,50€

PLACA DE CIRCUITO IMPRESSO

15125 23,00€



Use-os com baterias JBM: uma única bateria adequada para todas as ferramentas

BATERIA DE LÍTIO

2.0Ah



60012

4.0Ah



60013

6.0Ah



60015

CARREGADOR



4A 60016



CARREGADOR RÁPIDO

6A 60017



# LAVADORA DE ALTA PRESSÃO A BATERIA BRUSHLESS

A lavadora de alta pressão com motor BRUSHLESS é projetada para a limpeza de veículos, equipamentos, ferramentas, móveis de jardim, etc.

**60039** 265,00€

3.30 - 2 36  
Kg SUB

Bateria não incluída.



319-507 PSI  
22-25 BAR

**20V**

2.0-2.4 L/min

2.0 kg



Inclui um bico ajustável que permite selecionar o fluxo de água apropriado dependendo da sujeira a ser removida e da superfície a ser limpa.

TAMPA DE ROSCA PARA VÁLVULA DE ABASTECIMENTO DE ÁGUA

**15481** 4,50€

CONECTOR DA TUBULAÇÃO DE ABASTECIMENTO DE ÁGUA

**15484** 5,50€

CONJUNTO DE 6 VÁLVULAS UNIDIRECIONAIS

**15487** 59,00€

AGULHA DA VÁLVULA DE RETENÇÃO PARA TUBULAÇÃO DE ENTRADA E SAÍDA

**15490** 4,00€



ANEL SUPERIOR DA MOLA PARA A VÁLVULA DE ABASTECIMENTO DE ÁGUA

**15482** 4,00€

ANEL SELADO PARA O INTERRUPTOR

**15485** 4,00€

ANEL DE VEDAÇÃO PARA TUBOS DE ENTRADA E SAÍDA

**15488** 4,00€

MOLA DA VÁLVULA DE ALÍVIO DE PRESSÃO

**15491** 4,00€

MOLA DA VÁLVULA DE ABASTECIMENTO DE ÁGUA

**15483** 4,00€

INTERRUPTOR PARA O PULVERIZADOR DA LAVAGEM

**15486** 9,00€

TUBULAÇÃO DE ENTRADA E SAÍDA

**15489** 10,50€

COTOVELO DA TUBULAÇÃO

**15492** 5,00€

MOLA

**15493** 4,50€

# PULVERIZADOR ELÉTRICO INDUSTRIAL DE MOCHILA COM TANQUE DE 15 L

**60027** 99,00€

5.65 - 1 15  
Kg SUB

Bateria não incluída.

Compatível com a REF 60012 - 60013

A ferramenta é adequada para a desinfecção de casas particulares, locais públicos, fazendas de gado, jardins, etc., e permite destruir todas as partículas perigosas, impedir a sua propagação e impedir a reprodução de insetos e o desenvolvimento de doenças.

Manivela inteligente com intertravamento para operação contínua.

Também estão incluídos no pacote 4 bicos com capacidade e fluxo específicos, dependendo dos requisitos: 1 bico cônico oco, 1 bico cônico duplo oco, 1 bico ajustável com 4 orifícios, 1 bico do ventilador.

Suporte de pulverização telescópico.



**20V**

**15L**

0.3-0.45 Mpa

1-1.2m

40 - 80cm

Tampa de enchimento com trava

Alça para fácil transporte

Suporte para instalação da prateleira



Almofada RESPIRÁVEL E ERGONÔMICA para as costas para evitar a sensação de peso após uso prolongado e para facilitar a separação e distribuição do suor.



- Ele inclui:

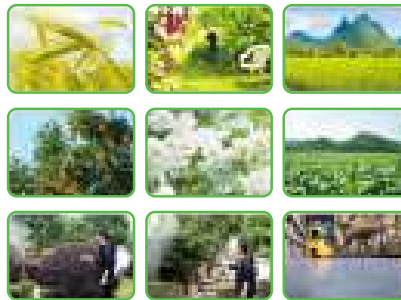

Use-os com baterias JBM: uma única bateria adequada para todas as ferramentas

BATERIA DE LITIO

2.0Ah



**60012**

4.0Ah



**60013**

6.0Ah



**60015**

CARREGADOR



4A  
**60016**



CARREGADOR RÁPIDO  
6A  
**60017**



## SERRA ELÉTRICA COM MOTOR BRUSHLESS

60029 240,00€

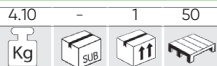

Bateria não incluída.

Esta ferramenta florestal foi projetada para tarefas como **derrubar, desgalhar, serrar e cortar árvores**. A ferramenta está equipada com uma alça para ajustar a tensão da barra guia e da corrente, um freio da corrente para parar a corrente ao recuar e um prendedor da corrente para segurá-la se ela quebrar ou se soltar. A ferramenta também possui um **sistema de lubrificação automática** da corrente e um botão de travamento do gatilho para evitar partidas acidentais. A ferramenta consiste numa barra guia, uma corrente e uma **cobertura para proteger** a barra e a corrente durante o transporte e armazenamento.

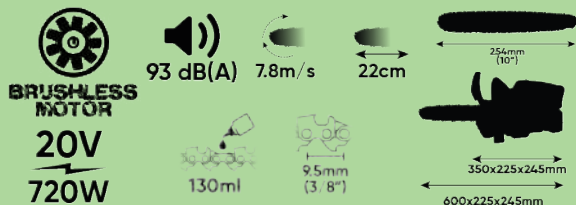

INTERRUPTOR DE SINAL

15098 11,50€

BOMBA DE ÓLEO

15101 11,00€

CORRENTE DE SERRA

15104 31,50€

GATILHO

15099 5,50€

ROTOR

15102 40,00€

BARRA DE GUIA

15105 30,00€

PLACA DE CIRCUITO IMPRESSO

15100 70,00€

ESTATOR

15103 20,50€

ALÇA EM D ADICIONAL

15106 15,00€

JOGO DE LIMAS PARA SERRA ELÉTRICA

54128 10,50€



## ELETROSERRA TELESCÓPICA

60031 142,00€

Bateria não incluída.



Esta ferramenta foi projetada para **tarefas de jardinagem** rápidas e fáceis, como corte de cercas vivas ou arbustos. Leveza de construção e alimentação por bateria **facilitam o transporte** da ferramenta de um local para outro.

O kit inclui uma **tampa protetora de lâmina** para manter o corta-sebes em boas condições, **uma cobertura** para ajudar a manter aparas ou outros detritos longe **das mãos e olhos do operador** e uma **alça extra** para maior controle e um ambiente de trabalho confortável. Além disso, o design oferece dois interruptores e um **botão de bloqueio**, que evita o acionamento acidental da ferramenta.

**20V**  
**230W**

93dB(A)

1490RPM

475mm

2.5m/s2

18mm

45°

920x215x192mm

INTERRUPTOR DE GATILHO TRASEIRO

15114 6,00€

CONJUNTO DE DISCO DE CORTE

15118 52,00€

MICRO INTERRUPTOR #8

15115 8,50€

MICRO INTERRUPTOR #31

15119 10,00€

PLACA DE CIRCUITO

15116 29,50€

INTERRUPTOR DE GATILHO DIANTEIRO

15120 6,50€

MOTOR

15117 29,50€

ALÇA AUXILIAR D

15121 12,00€

Use-os com baterias JBM: uma única bateria adequada para todas as ferramentas

BATERIA DE LITIO

2.0Ah



60012

4.0Ah



60013

6.0Ah



60015

CARREGADOR



4A  
60016



CARREGADOR RÁPIDO  
6A  
60017



# MÁQUINA DE JARDIM MULTIFUNCIONAL ELÉTRICA (4 EM 1)

60040 440,00€

Bateria não  
incluída.

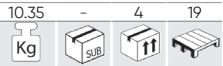

A ferramenta elétrica multifuncional 4 em 1 para jardim foi projetada para uma ampla variedade de tarefas ao ar livre, como limpar espaços verdes, aparar sebes, cortar galhos e muito mais. A ferramenta é ideal para a manutenção completa do jardim.

- Ele inclui:



- O conjunto completo inclui serra, tesoura de treliça e roçadeira com cabeça roscada e lâmina tripla.



## ROLAMENTO

15462 7,50€

## ROATÁ DINȚĂȚĂ

15465 11,50€

## PINO

15468 2,50€

## GUIDA PER SEGA AD ASTA

15471 20,10€

## CORRENTE DE SERRA DE PÓLO

15472 19,00€

## CABEÇA DE CORTE DE GRAMA

15473 13,70€

## ROTOR

15463 114,00€

## ROLAMENTO

15466 6,50€

## EIXO DE SAÍDA

15469 9,50€

## CORDA PARA CORTADOR DE ESCOVA

15474 8,50€

## LÂMINA DE CORTADOR DE ESCOVA DE TRÊS DENTES

15475 8,50€

## TAMPA DE PROTEÇÃO DE CORTADOR DE ESCOVA

15476 11,00€

## ROLAMENTO

15464 6,50€

## ENGRENAGEM

15467 14,00€

## ROLAMENTO

15470 7,50€

## BASE DA TAMPA DE PROTEÇÃO DE CORTADOR DE ESCOVA

15477 5,70€

## LÂMINA DE CORTADOR DE ESCOVA

15478 3,60€



## SOPRADOR DE FOLHAS

60030 112,00€



Bateria não incluída.

Esta ferramenta foi projetada para **recolher folhas, grama, papel e materiais semelhantes**. Leveza de construção e alimentação por bateria facilitam o transporte da ferramenta de um local para outro.

O design apresenta um interruptor de **fluxo de ar alto/ baixo** e interruptor de volume e uma **alça macia** para fácil operação.



## MICRO INTERRUPTOR

15107 4,00€



## PLACA DE CIRCUITO IMPRESSO

15109 25,50€



## MOTOR

15111 30,40€



## BAIXO

22m/s (49MPH)  
312m³/h (116CFM)



## ALTO

38m/s (85MPH)  
520m³/h (310CFM)

## TUBULAÇÃO DE SANGRIA

15113 11,80€

## INTERRUPTOR DE GATILHO

15108 2,16€

## CHAVE

15110 6,55€

## CONE DE DIVERSÃO DE ENTRADA

15112 3,25€

Use-os com baterias JBM: uma única bateria adequada para todas as ferramentas

## BATERIA DE LÍTIO

2.0Ah



60012

4.0Ah



60013

6.0Ah



60015

## CARREGADOR

4A



60016

6A



CARREGADOR RÁPIDO

60017

# ROBÔ CORTA-RELVA

**52598** 1.080,00€

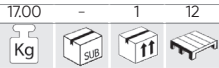

- Robô cortador de grama autônomo.  
- Sem fio e fácil de guardar.



<b>5200 mAh</b> Capacidade da bateria Battery capacity	<b>1400m²</b> Superfície de corte Mowing area	<b>2,5H</b> 	<b>2H</b> 	<b>22m/min</b> 
<b>115,44W</b> Consumo de energia Power consumption	<b>AC 100-240V</b> 50 / 60Hz Tensão de entrada Input Voltage	<b>DC 15-25,5V</b> Tensão de saída Output Voltage	<b>IP X4</b>	<b>70 dB</b> 

Altura de corte:  
2,5 - 5,5cm

Largura de corte: 18cm

estação para carregar

Velocidade de rotação da lâmina: 3500rpm



CONEXÃO DE APP



SUPORTES PARA FIO DE CONEXÃO 150 PÇS  
**15425** 50,00€

MOTOR DA RODA TRASEIRA  
**15434** 147,00€

LÂMINA DE CORTE E PARAFUSOS 3 PÇS  
**15426** 10,00€

PLACA DE CORTE E PLACA DE PROTEÇÃO  
**15435** 24,50€

RODAS DIANTEIRAS  
**15439** 52,00€

MOTOR DE CORTE  
**15436** 97,00€

PREGOS DA ESTAÇÃO DE INSTALAÇÃO 4 PÇS  
**15427** 9,00€

MÃE PLACA  
**15437** 305,50€

BATERIA 22,2 V, 2 600 mAh  
**15428** 238,00€

SENSOR DO FIO DE CONEXÃO  
**15438** 31,00€

ESTACION BASE  
**15431** 241,00€

FIO DE EXTENSÃO 5 M  
**15429** 23,50€

TOMADA DO FIO DE CONEXÃO  
**15432** 18,50€

ADAPTADOR  
**15430** 83,00€

GARAGEM PARA CORTADOR DE GRAMA  
**15433** 197,00€

FIO DE CONEXÃO 150 M  
**15424** 105,00€

# CORTA-RELVA SEM FIO

**60045** 298,00€



**40V**

**BRUSHLESS MOTOR**

**800W**



370x45mm

3300 RPM

4000 mAh  
Capacidade da bateria  
Battery capacity

IP X1  
35L

96 dB(A)

Altura de corte:  
6 (25-75mm)



Ø 20,32cm

Ø 15,24cm

42cm

68cm

CABO  
**16138** 7,45€

SUPORTE DA PÁ DA VENTONINHA  
**16141** 4,45€

PCI - #68-4 (REF.60045)  
**16145** 79,00€

CAIXA DE RELVA - #6 (REF.60045)  
**16139** 14,20€

LÂMINA DE 370MM - #20 (REF.60045)  
**16142** 10,80€

MICRO-INTERRUPTOR - #68-10 (REF.60045)  
**16146** 4,45€

CHAVE DE SEGURANÇA PARA REF.60045 #61  
**16160** 3,99€

CONJUNTO DO ESTATOR - #32-13 (REF.60045)  
**16149** 38,60€

PARAFUSO LÂMINA - #21 (REF.60045)  
**16143** 2,06€

ENGRENAGEM GRANDE - #32-5 (REF.60045)  
**16147** 13,00€

RODA TRASEIRA - #13 / (REF.60045)  
**16140** 14,20€

RODA DIANTEIRA - #23 (REF.60045)  
**16144** 12,80€

CONJUNTO DO ROTOR - #32-11 (REF.60045)  
**16148** 35,40€





## BANDEJA

14622 17,00€

0,95 - 10 360



PARA REF. 60001, 60003, 60004, 60020

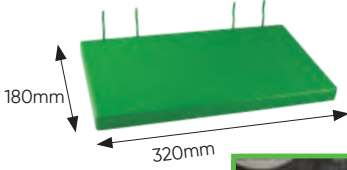

14624 17,00€

0,65 - 10 300



PARA REF. 60007, 60010, 60011

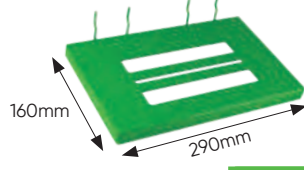

## GANCHO

14625 14,00€

0,50 - 10 700



PARA REF. 60008, 60009

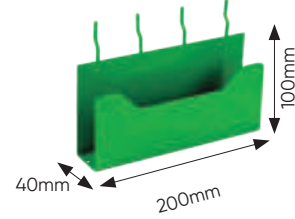

## GANCHO

14623 8,00€

0,10 - 10 800

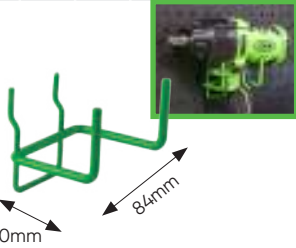

PARA REF. 60005, 60006, 60018

14626 7,00€

0,10 - 10 -

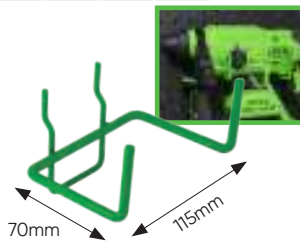

PARA REF. 60023

## BOLSA PARA FERRAMENTAS ELÉTRICAS

53702 28,50€

1,00 - 5 180



PEQUENA



53703 41,00€

1,40 - 5 120



MÉDIA



53704 42,00€

1,65 - 5 120



GRANDE



## BOLSA PARA FERRAMENTAS ELÉTRICAS - GRANDE

53782 14,00€

0,65 - 20 160



25Kg/13L



DIVISÓRIA INTERNA



BOLSOS TRASEIROS E LATERAIS

## MOCHILA PARA FERRAMENTAS

53258 67,00€

2,60 - 2 32



15Kg

1.165mm 575mm 230mm

- Não inclui ferramentas.



## MALA DE FERRAMENTAS

53253 98,00€

4,50 - 2 12



20Kg/18L

- 600D Polyester.  
- Não inclui ferramentas.

420mm 360mm 250mm



# Use-os com baterias JBM: uma única bateria adequada para todas as ferramentas

Três tipos de bateria e dois tipos de carregador. Escolha o que você preferir!

\*Pilhas e carregadores NÃO INCLUIDOS nas ferramentas.



## BATERIA DE LITIO



INDICADOR DE ENERGIA



PROTEÇÃO CONTRA CURTO-CIRCUITO



PROTEÇÃO CONTRA SUPERAQUECIMENTO



PROTEÇÃO CONTRA SOBRECARGA

### 20V

### 12V

2.0Ah



4.0Ah



6.0Ah



2.0Ah



60012

48,00€

0.45	-	30	920
Kg	Sub	ft	ft

60013

80,00€

0.75	-	5	700
Kg	Sub	ft	ft

60015

138,00€

1.00	-	20	600
Kg	Sub	ft	ft

PARA REF. 60024

60026

3790€

0.20	8	5	1400
Kg	Sub	ft	ft

## CARREGADOR

50-60Hz

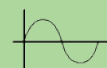

100V  
240V



INDICADOR DE ENERGIA



PROTEÇÃO CONTRA SUPERAQUECIMENTO



PROTEÇÃO CONTRA SOBRECARGA

### 20V



PROTEÇÃO CONTRA CURTO-CIRCUITO

### 12V



4A

60016

49,00€

0.80	-	5	210
Kg	Sub	ft	ft



6A RÁPIDO

60017

64,00€

0.80	-	5	290
Kg	Sub	ft	ft



CARREGADOR DE 12 V  
PARA REF. 60026

60025

31,60€

0.30	5	4	700
Kg	Sub	ft	ft

2.0AH	4.0AH
30min +/-10min	60min +/-15min
6.0AH	
90min +/-15min	

2.0AH	4.0AH
30min +/-10min	45min +/-10min
6.0AH	
60min +/-15min	

2.0AH
60min +/-10min



## FORMÃO SDS-PLUS

- Material: aço 40Cr, jato de areia.



60023

PARA ALVENARIA

DE FINO AFIADO - 14x250mm

**14837** 3,30€

0.30	5	4	700
Kg	Sub	Box	Tray

DE FINO PLANO - 20x250mm

**14838** 3,40€

0.25	10	100	-
Kg	Sub	Box	Tray

DE SULCO - 250mm

**14840** 3,35€

0.27	10	50	-
Kg	Sub	Box	Tray

DE FINO PLANO - 40x250mm

**14839** 4,70€

0.29	10	50	-
Kg	Sub	Box	Tray



## ADAPTADOR SDS-PLUS DE 1/2" PARA CARTUCHO DE PERFURAÇÃO

**14841** 2,58€

0.05	50	250	-
Kg	Sub	Box	Tray

- Material: aço 40Cr, jato de areia  
- Comprimento: 7,5 cm  
- Diâmetro: 1 cm  
- Peso: 45 g

60023



PARA ALVENARIA



## CONJUNTO DE BROCAS PARA BERBEQUIM PERCUTOR

**53850** 14,90€

0.65	5	25	1000
Kg	Sub	Box	Tray



60023

5x110, 6x110, 6x160, 8x110, 8x160, 10x160, 12x160mm



PARA ALVENARIA

- Ranhura simples, ponta plana, uso do jato de areia.  
- Material: pontas de aço de liga YG8, base de aço carbono.



### REPOSIÇÕES DISPONÍVEL

REF.	mm	Kg	Sub	Box	Tray	€
14826	Ø 5x110mm	0,05	125	500		1,50€
14828	Ø 6x110mm	0,05	25	500		1,50€
14830	Ø 8x110mm	0,04	25	500		1,50€
14829	Ø 6x160mm	0,04	25	500		1,50€
14831	Ø 8x160mm	0,05	25	500		1,50€
14832	Ø 10x160mm	0,05	25	200		2,00€
14920	Ø 12x160mm	0,10	100	200		2,50€

### VOCÊ PODE GOSTAR...

REF.	mm	Kg	Sub	Box	Tray	€
14825	Ø 4x110mm	0,05	100	200		1,50€
14827	Ø 5x160mm	0,04	25	500		2,00€
14833	Ø 10x210mm	0,10	20	200		2,05€
14834	Ø 12x210mm	0,10	100	200		2,50€
14835	Ø 14x210mm	0,10	20	125		3,00€
14836	Ø 16x210mm	0,14	20	120		3,50€

## PORTA-BROCAS DE MUDANÇA RÁPIDA 2-13 MM 1/2"-20 UNF

**14842** 9,50€

0.26	5	50	-
Kg	Sub	Box	Tray

- Tipo: sem chave  
- Faixa de fixação: 2-13 mm  
- Rosca: 1/2"-20UNF



- Material: aço  
- Comprimento: 6 cm  
- Diâmetro: 4 cm

60023

## KIT DE BROCAS PARA CONCRETO

- Material: pontas de aço de liga YG8, base de aço carbono.

3-10MM

**53861** 5,45€

0.20	5	50	950
Kg	Sub	Box	Tray

3x60, 4x75, 5x80, 6x100, 7x100, 8x120, 9x120, 10x120mm

4-10MM

**53860** 3,65€

0.15	5	50	950
Kg	Sub	Box	Tray

4x75, 5x80, 6x100, 8x120, 10x120mm

8 PCS

5 PCS



PARA ALVENARIA

60006

### REPOSIÇÕES DISPONÍVEL

REF.	mm	Kg	Sub	Box	Tray	€
14907	Ø 3x60mm	0,01	50	100		0,50€
14908	Ø 4x75mm	0,01	50	100		0,60€
14909	Ø 5x80mm	0,01	50	100		0,80€
14910	Ø 6x100mm	0,01	50	100		1,00€
14911	Ø 7x100mm	0,01	50	100		1,30€
14912	Ø 8x120mm	0,05	50	100		1,55€
14913	Ø 9x120mm	0,05	50	100		1,90€
14914	Ø 10x120mm	0,04	20	100		2,10€

### VOCÊ PODE GOSTAR...

REF.	mm	Kg	Sub	Box	Tray	€
14915	Ø 11x150mm	0,05	20	100		2,65€
14916	Ø 12x150mm	0,06	20	100		2,95€
14917	Ø 13x150mm	0,10	20	100		3,45€



REPOSIÇÕES DISPONÍVEL



REPOSIÇÕES DISPONÍVEL



# KIT DE BROCAS ESPIRAIS HSS 4341

- Material: HSS 4341

1-10MM

**53852** 207,00€

4,20 - 4 192



**170**  
PCS

1x34, 1,5x40, 2x49, 2,5x57, 3x61, 3,5x70, 4x75, 4,5x80, 5x86, 5,5x93, 6x93, 6,5x101, 7x109, 7,5x109, 8x117, 8,5x117, 9x125, 9,5x125, 10x133mm

- O conjunto inclui 170 brocas:  
1,0 - 8,0 mm x 10 peças (a cada 0,5 mm),  
8,5 - 10 mm x 5 peças (a cada 0,5 mm).



REPOSIÇÕES  
DISPONÍVEL

1-13MM

**53856** 62,00€

1,32 5 10 550



**25**  
PCS

1x34, 1,5x40, 2x49, 2,5x57, 3x61, 3,5x70, 4x75, 4,5x80, 5x86, 5,5x93, 6x93, 6,5x101, 7x109, 7,5x109, 8x117, 8,5x117, 9x125, 9,5x125, 10x133, 10,5x133, 11x142, 11,5x142, 12x151, 12,5x151, 13x151mm



REPOSIÇÕES  
DISPONÍVEL

1-10MM

**53854** 27,00€

0,63 5 20 192



**19**  
PCS

1x34, 1,5x40, 2x49, 2,5x57, 3x61, 3,5x70, 4x75, 4,5x80, 5x86, 5,5x93, 6x93, 6,5x101, 7x109, 7,5x109, 8x117, 8,5x117, 9x125, 9,5x125, 10x133mm



REPOSIÇÕES  
DISPONÍVEL

# KIT DE BROCAS ESPIRAIS HSS 4241 PRETO

- Material: HSS 4241 PRETO.

1-10MM

**53851** 88,00€

3,80 - 4 192



**170**  
PCS

1x34, 1,5x40, 2x49, 2,5x57, 3x61, 3,5x70, 4x75, 4,5x80, 5x86, 5,5x93, 6x93, 6,5x101, 7x109, 7,5x109, 8x117, 8,5x117, 9x125, 9,5x125, 10x133mm

- O conjunto inclui 170 brocas:  
1,0 - 8,0 mm x 10 peças (a cada 0,5 mm),  
8,5 - 10 mm x 5 peças (a cada 0,5 mm).



REPOSIÇÕES  
DISPONÍVEL

1-13MM

**53855** 24,80€

1,19 5 10 192



**25**  
PCS

1x34, 1,5x40, 2x49, 2,5x57, 3x61, 3,5x70, 4x75, 4,5x80, 5x86, 5,5x93, 6x93, 6,5x101, 7x109, 7,5x109, 8x117, 8,5x117, 9x125, 9,5x125, 10x133, 10,5x133, 11x142, 11,5x142, 12x151, 12,5x151, 13x151mm



REPOSIÇÕES  
DISPONÍVEL

1-10MM

**53853** 14,40€

0,58 5 20 192



**19**  
PCS

1x34, 1,5x40, 2x49, 2,5x57, 3x61, 3,5x70, 4x75, 4,5x80, 5x86, 5,5x93, 6x93, 6,5x101, 7x109, 7,5x109, 8x117, 8,5x117, 9x125, 9,5x125, 10x133mm



REPOSIÇÕES  
DISPONÍVEL

60006

HSS-G  
4341



PARA  
METAIS

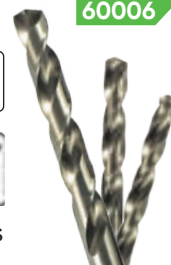

REPOSIÇÕES  
DISPONÍVEL

REF.	mm	Kg	Sub	Qt	€
14868	Ø 1x34mm	0,01	50	400	0,55€
14869	Ø 1,5x40mm	0,01	50	400	0,60€
14870	Ø 2x49mm	0,01	50	400	1,00€
14871	Ø 2,5x57mm	0,01	50	400	1,00€
14872	Ø 3x61mm	0,01	50	400	1,00€
14873	Ø 3,5x70mm	0,01	50	400	1,00€
14874	Ø 4x75mm	0,01	50	400	1,00€
14875	Ø 4,5x80mm	0,01	50	400	1,50€
14876	Ø 5x86mm	0,01	50	300	1,50€
14877	Ø 5,5x93mm	0,02	50	300	1,50€
14878	Ø 6x93mm	0,02	25	400	2,00€
14879	Ø 6,5x101mm	0,02	25	400	2,00€
14880	Ø 7x109mm	0,03	25	400	2,50€
14881	Ø 7,5x109mm	0,03	25	400	2,50€
14882	Ø 8x117mm	0,04	25	400	3,00€
14883	Ø 8,5x117mm	0,04	25	400	3,50€
14884	Ø 9x125mm	0,05	25	400	3,65€
14885	Ø 9,5x125mm	0,05	25	400	4,00€
14886	Ø 10x133mm	0,06	25	400	4,60€
14887	Ø 10,5x133mm	0,07	25	400	5,00€
14888	Ø 11x142mm	0,08	25	400	6,00€
14889	Ø 11,5x142mm	0,09	25	400	6,50€
14890	Ø 12x151mm	0,10	25	300	7,00€
14891	Ø 12,5x151mm	0,09	25	200	7,50€
14892	Ø 13x151mm	0,09	25	200	8,00€

60006

HSS-R  
4241



PARA  
METAIS



REPOSIÇÕES  
DISPONÍVEL

REF.	mm	Kg	Sub	Qt	€
14843	Ø 1x34mm	0,01	50	400	0,50€
14844	Ø 1,5x40mm	0,01	50	400	0,50€
14845	Ø 2x49mm	0,01	50	400	0,50€
14846	Ø 2,5x57mm	0,01	50	400	0,50€
14847	Ø 3x61mm	0,01	50	400	0,50€
14848	Ø 3,5x70mm	0,01	50	400	0,50€
14849	Ø 4x75mm	0,01	50	400	1,00€
14850	Ø 4,5x80mm	0,01	50	400	1,00€
14851	Ø 5x86mm	0,01	50	300	1,00€
14852	Ø 5,5x93mm	0,02	50	300	1,00€
14853	Ø 6x93mm	0,02	25	400	1,00€
14854	Ø 6,5x101mm	0,02	25	400	1,00€
14855	Ø 7x109mm	0,03	25	400	1,00€
14856	Ø 7,5x109mm	0,03	25	400	1,00€
14857	Ø 8x117mm	0,03	25	400	1,50€
14858	Ø 8,5x117mm	0,04	25	400	1,50€
14859	Ø 9x125mm	0,04	25	400	1,50€
14860	Ø 9,5x125mm	0,05	25	400	2,00€
14861	Ø 10x133mm	0,06	25	400	2,00€
14862	Ø 10,5x133mm	0,07	25	400	2,00€
14863	Ø 11x142mm	0,07	25	400	2,50€
14864	Ø 11,5x142mm	0,07	25	400	2,50€
14865	Ø 12x151mm	0,08	25	300	2,50€
14866	Ø 12,5x151mm	0,09	25	200	3,00€
14867	Ø 13x151mm	0,09	25	200	3,00€



## CONJUNTO DE PONTAS DE IMPACTO COM ADAPTADOR RÁPIDO S2

53857 27,00€

0,40	6	24	1152
Kg	Sub	11	11

- Material: aço S2, revestimento preto oxidado da ponta, padrão DIN.

- Contém:

49 peças de bits de impacto de 25mm:

PH1x3, PH2x3, PH3x3

PZ1x3, PZ2x3, PZ3x3

SL4x2, SL5x2, SL6x2

H:3,4,5

T:10x2, 15x2, 20x2, 25x2, 27x2, 30x2, 40x2

T INVOLABLE:10,15,20,25,27,30,40

7 pcs. de bits de impacto de 65 mm com ponta: PH2, PH3, PZ1, PZ2, T20, T25, SL6

1 pc. do adaptador de mandril de troca rápida de aço inoxidável de 60mm.

60005/60006

ACO S2 49 PCS



EM EXPOSITOR DE 6 UDS



## CONJUNTO DE PONTAS COM ADAPTADORES S2- REVESTIMENTO PRETO

53858 28,80€

0,55	6	24	672
Kg	Sub	11	11

- Material: aço S2, revestimento oxidado preto de ponta.

- Contém:

21 pcs. de bits de impacto de 25 mm:

PH:1,2,2,3

PZ:1,2,3

H:3,4,5,6

SL:3,4,5,6

T:10,15,20, 25, 30, 40

6 pcs. de bits de impacto de 75 mm: T15, T20, T25, PH2, PZ2, SL5

1 pc. da barra de extensão de 80 mm

1 pc. dp adaptador de mandril de troca rápida de 60 mm

4 pcs. de chaves de 48 mm: 6,7,8,10 mm

60005/60006

ACO S2 33 PCS



EM EXPOSITOR DE 6 UDS

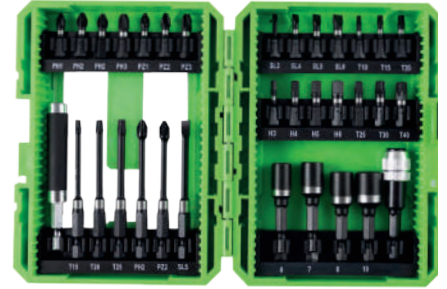

## CONJUNTO DE PREGOS SEM CABEÇA

REF.		Kg	11	€
53999	25x1.25mm	0,20	50	2,00€
54000	30x1.25mm	0,24	50	2,50€
54002	38x1.25mm	0,29	50	3,00€

60037

1000 PCS

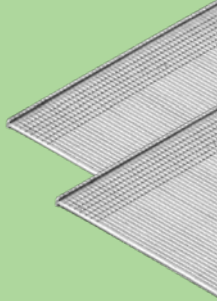
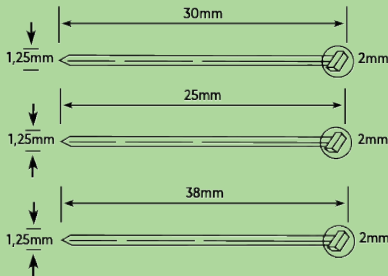

## CONJUNTO DE GRAMPOS COM PARTE SUPERIOR ESTREITA DE TAMANHO 18

REF.		Kg	11	€
54008	25x6mm	0,43	40	3,50€
54010	32x6mm	0,47	40	4,50€
54011	38x6mm	0,63	40	5,00€

60037

1000 PCS

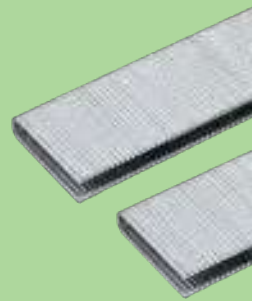
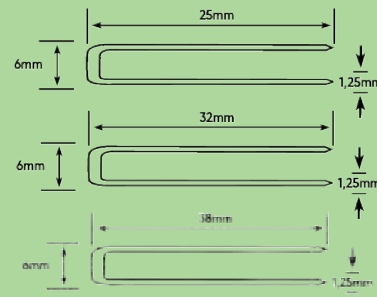

## CONJUNTO BROCAS CRANEADAS COM ADAPTADORES

53859 67,00€

1,35	5	10	140
Kg	Sub	11	11

- Para cortar metal e aço.  
- Material de serra circular:  
Dentes: Bimetal HSS M42, 4-6TPI  
Corpo: Aço carbono  
- Material do mandril: Bimetal HSS.

CONTÉM

	x6	22, 29, 35, 44, 51, 68mm
	x2	14-30mm, 32-152mm



60006

HSS M42 4-6TPI 8 PCS



PARA METAIS E AÇO INOXIDÁVEL

### REPOSIÇÕES DISPONÍVEL

REF.	mm	Kg	Sub	11	€
14901	Serra 22mm	0,04	10	50	3,60€
14902	Serra 29mm	0,08	10	50	4,65€
14903	Serra 35mm	0,10	10	50	5,25€
14904	Serra 44mm	0,12	10	50	6,85€
14905	Serra 51mm	0,12	10	50	8,50€
14906	Serra 68mm	0,19	10	50	10,20€
14934	Mandril 14-30mm	0,07	10	50	4,25€
14935	Mandril 32-152mm	0,2	10	50	8,45€

IVA não incluído

JBM / www.jbmcamp.com

111

## PARA METAL (AÇO INOXIDÁVEL, ALUMÍNIO, COBRE)

PARA	REF.	DESCRIÇÃO	Kg	Paq	Caixa	€
60011	14989	Serra circular 24 dentes 115mm	0,08	-	20 100	6,00€
60007	14988	Serra circular 24 dentes 165mm	0,19	-	20 40	8,00€
60022	14990	Serra circular 40 dentes 185mm	0,26	-	20 40	10,50€
60019	14995	Lâminas de serra reciprocadora 150mm 24tpi	0,01	2	20 200	8,00€
60010	14993	Lâminas da serra de rodear t118a	0,01	5	20 200	5,00€

## PARA MADEIRA

PARA	REF.	DESCRIÇÃO	Kg	Paq	Caixa	€
60011	14986	Serra circular 24 dentes 115mm	0,07	-	20 100	4,00€
60007	14985	Serra circular 24 dentes 165mm	0,18	-	20 40	6,00€
60022	14987	Serra circular 40 dentes 185mm	0,24	-	20 40	8,50€
60019	14994	Lâminas de serra reciprocadora 150mm 6tpi	0,01	2	20 200	3,50€
60010	14991	Lâminas da serra de rodear t244d	0,01	5	20 200	2,00

14989 14986



- Material: lâminas YG8, base de carboneto de tungstênio.

14988 14985



- Material: lâminas YG8, base de carboneto de tungstênio.

14990 14987



- Material: lâminas YG8, base de carboneto de tungstênio.

14995



- Material: aço rápido.

14993



- Material: aço rápido.

14994



- Material: aço de alto carbono.

14991



- Material: aço de alto carbono.

## DISCO DE CORTE

- Material: Óxido de alumínio fundido monocristalino SA 50% / Óxido de alumínio fundido branco 50%

### PARA METAL

REF.	DESCRIÇÃO	Kg	Paq	Caixa	€
14893	T42 - 115x2.5mm	0,05	50	100	2,00€
14894	T42 - 125x2.5mm	0,70	50	100	1,20€
14895	T27 - 115x6mm	0,15	25	100	1,90€
14896	T27 - 125x6mm	0,78	25	100	2,10€



### PARA AÇO INOXIDÁVEL

REF.	DESCRIÇÃO	Kg	Paq	Caixa	€
14897	T41 - 115x1mm	0,01	50	400	0,88€
14898	T41 - 125x1mm	0,03	50	400	0,98€
14899	T41 - 115x1.6mm	0,03	50	400	0,88€
14900	T41 - 125x1.6mm	0,04	50	400	0,98€



14893 T42



14895 T27



14897 T41



14898 T41



14894 T42



14896 T27



14899 T421



14900 T41



## PORCA DE REMOÇÃO RÁPIDA M14 PARA REBARBADORA

15014 20,00€

0.10	50	100	-
Kg	SUB	T1	



60008/60023







# **ILUMINAÇÃO**

- 114 GAMBIARRAS
- 118 GAMBIARRA DE LUZ FRONTAL
- 119 LUPAS LED / LANTERNAS
- 120 FOCO DE LED/ALINHADORES DE FARÓIS/ TOMADAS E TRANSFORMADORES DE ISQUEIRO
- 121 BARRAS DE LED
- 122 LÂMPADA DE LED INDUSTRIAL
- 122 LUZ DE EMERGÊNCIA - ROTATIVOS
- 125 AVISOS ACÚSTICOS
- 126 LUZES DE TRABALHO
- 127 PARA REBOQUE
- 129 LÂMPADAS DE TURISMO

# LANTERNA DE TRABALHO 400LM

**53734** 23,70€

0,25 20 60 1260



30-400 Lm 3-4H



LED COB 30lm 10H LED COB 400lm 2,5H



BASE ROTATIVA MAGNETIZADA 360°



380mm

32mm



poterosa luz LED: de 30Lm a 400Lm



SELETOR DE INTENSIDADE DE LUZ



COM CABIDE



CARREGADOR USB



EM EXPOSITOR DE 20 UDS

# GAMBIARRA COB EXTRAFINO

**53519** 42,00€

0,20 12 72 720



EM EXPOSITOR DE 12 UDS

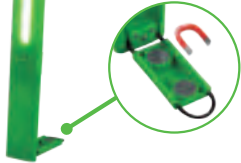

EXTRAFINO



12mm

300mm

38mm

# GAMBIARRA EXTRAPLANA COM LED COB COM BATERIA RECARREGÁVEL

**52536** 57,00€

0,40 - 10 320



360mm

50mm





# GAMBIARRA COM BASE MAGNÉTICA ARTICULADA

**54122** 38,00€

0.39	12	24	384
Kg	Sub	ff	ff

6500±400  
KELVIN

100V 240V USB 5V 1A

3.7V 2.0Ah IP 44

257mm 50mm 26mm

300 Lm 3-4H

LED 3W COB 2.5H LED 3W 7H

INCLUI CABO PARA CARREGAR

**54123** 40,00€

0.39	12	24	384
Kg	Sub	ff	ff

6500±400  
KELVIN

100V 240V USB 5V 1A

3.7V 4.0Ah IP 44

500 Lm 6-7H

LED 5W COB 3H LED 3W 14H

INCLUI CABO PARA CARREGAR

**54124** 47,00€

0.39	12	24	432
Kg	Sub	ff	ff

6500±400  
KELVIN

100V 240V USB 5V 1A

3.7V 4.0Ah IP 44

1000 Lm 6-8H

LED 10W COB 3H LED 3W 14H

INCLUI CABO PARA CARREGAR

LM1000 900 700  
5 min 30 min 145 min

EM EXPOSITOR DE 12 UDS

ADAPTADOR USB PARA TOMADA DE PAREDE

**14031** 7,90€

0.10	10	100	1152
Kg	Sub	ff	ff



## GAMBIARRA 24+6 LEDS COM IMAN DUPLO TRASEIRO

**51889** 49,00€

0.43	-	10	360
Kg	Sub	ff	ff

255mm 56mm

60 Lm x24+6 LED LITIO 3.7V 1400MAH 3-4H 4-5H

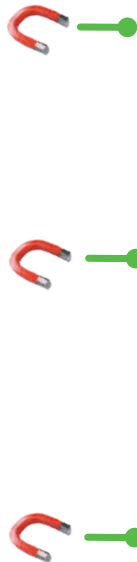

DUPLO GANCHO E DUPLO MAGNET

## LÂMPADA PORTÁTIL COB COM BASE FLEXÍVEL

**53216** 49,00€

0.60	-	10	120
Kg	Sub	ff	ff

200 Lm LED 7W COB 3.7V 2000MAH 4H 5V 1000MA 3-4H



LANTERNA SUPERIOR 6 LEDS 10H. AUTONOMIA



IVA não incluído

**JBM** / [www.jbmcamp.com](http://www.jbmcamp.com)

115

GAMBIARRAS

## LANTERNA DE BOLSO COM BATERIA

**53776** 19,10€

0,15 12 48 1920



### 3 MODOS DE LUZ

90-250 Lm

2,5H

3,5-6H

3,7V 1500MAH

ABS



EM EXPOSITOR DE 12 UDS

x1



x2



x3



x3

250 Lm  
LED 3W 3,9V



## LANTERNA DE BOLSO COM BATERIA

**52987** 20,00€

0,17 10 40 720



160mm 30mm 20mm



EM EXPOSITOR DE 10 UDS

120 Lm

LED 3W COB

3,7V 1500MAH



2,5H

2,5H



## LÂMPADA PORTÁTIL COB COM BATERIA

**52883** 38,00€

0,31 - 20 640



240mm 37mm



180+80 Lm

LED 2W COB



3,7V 1800MAH

4-5H

3,5-4H

## LÂMPADA PORTÁTIL COB ULTRAVIOLETA FLEXÍVEL COM BASE MAGNÉTICA

**53530** 46,00€

0,35 - 20 620



UV

5V 1A

3,7V 2.2Ah

LED 2W COB

4H



## LÂMPADA PORTÁTIL COB

**53217** 47,00€

0,30 - 20 620



200 Lm

LED 2W COB

3,7V 2600MAH

5V 1,000MA

4H

4H

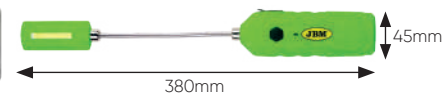
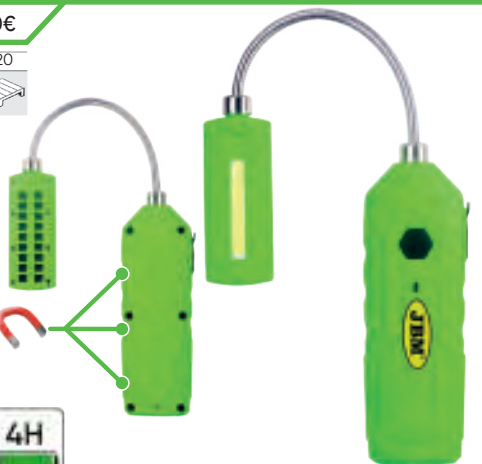



# LÂMPADA DE TRABALHO RECARREGÁVEL

**53974** 38,00€

0.75 5 20 240



Você quer ver como funciona?



4 MODOS DE ILUMINAÇÃO  
100% 50% SOS FLASH



MULTIPOSIÇÃO



# LUZ DE TRABALHO LED 400LM

**53780** 14,50€

0.45 5 20 280



CABO DE ALIMENTAÇÃO DE 2,5M

INCLUI GANCHO SUPERIOR PARA TRABALHAR CONFORTAVELMENTE

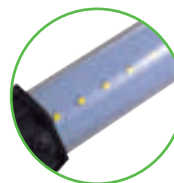

LUZ PODEROSA PERFEITA PARA ILUMINAR A ÁREA DE TRABALHO

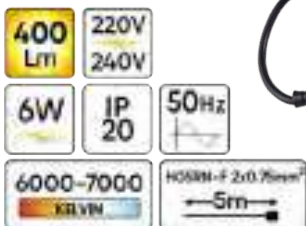

# GAMBIARRA EXTRAPLANA COM LED COB

**52384** 29,00€

0.33 - 20 600



- Comp. cabo: 5m
- DC Comp. cabo: 0,1m
- DC Comp. do cabo até às pinças: 0,3m

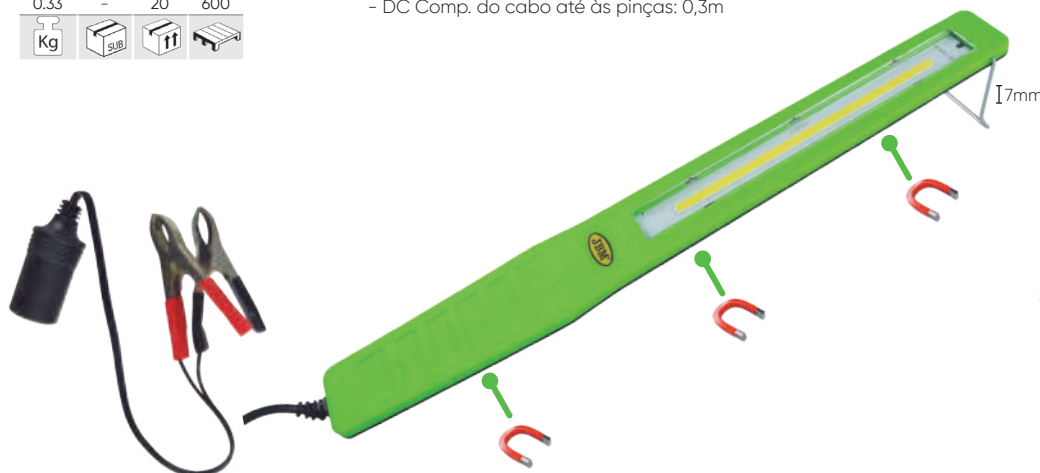

17mm

90mm

325mm

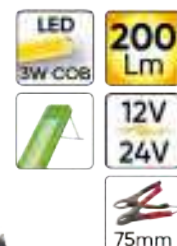

IVA não incluído



GAMBIARRAS



## LANTERNA LED DE CABEÇA COB

54004 23,00€

0.10 12 96 2592



COB + LED 350LM

350Lm 150Lm



150Lm 60Lm



- Material: sílica gel
- Indicador de energia, indicador de indução
- Modo de ativação do sensor de movimento
- Cabo de carregamento USB incluído

BOTÃO DO SENSOR DE MOVIMENTO



Pressione para ativar/desativar. Passe a mão na frente do botão para acender e apagar a luz.



## LUVA COM LUZ LED

54267 9,50€

0.05 10 60 2640



LED

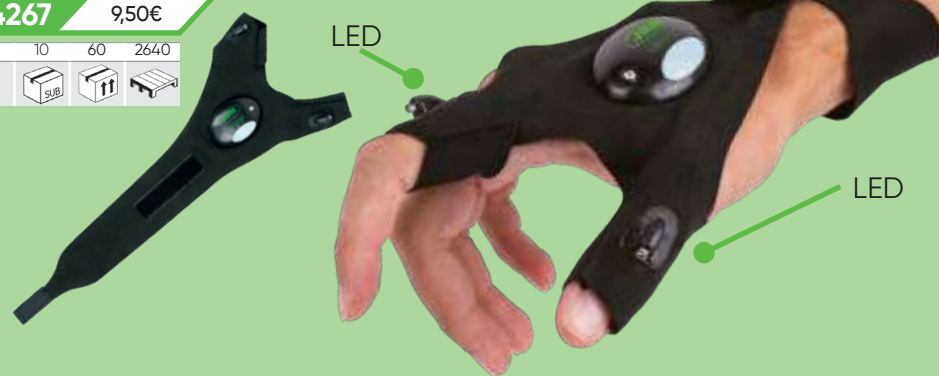

LED



## LANTERNA DE CABEÇA 800 LM (COB + CREE)

53569 18,00€

0.30 10 50 400



CREE + COB 800LM

3 MODOS DE LUZ



BATERIAS RECARREGÁVEIS

REGULADOR DE FOCO

INDICADOR LUMINOSO ACESO



## LANTERNA DE CABEÇA 350 LM

53568 12,00€

0.20 10 100 400



350LM

3 MODOS DE LUZ



REGULADOR DE FOCO





## LUPA LED DE MESA

**53227** 28,00€

0.60	6	24	192

- Até 500 ciclos de carga.  
- LED de luz branca, alta poupança.



## LUPA 8 LED (5x)

**53085** 30,00€

0.31	10	40	1500



## LANTERNA PLÁSTICA 9 LEDS

**52555** 2,38€

0.03	48	192	3456

**52558** 2,38€

0.03	48	192	3072

30mm	93mm
------	------



## LANTERNA DE 8 LEDS IMANTADA

**53427** 5,00€

0.05	12	96	3456

160mm	32mm
-------	------



## LANTERNA DE 21 LEDS

**51326** 4,40€

0.07	12	144	2880



EM EXPOSITOR DE 12 UDS

## LANTERNA DE DINAMO DE 2 LEDS

**51573** 2,50€

0.07	12	96	3456



APRESENTAÇÃO CAIXA INDIVIDUAL

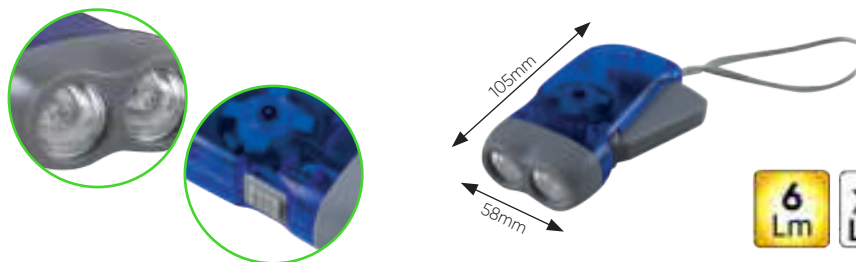

## PILHAS DE RECAMBIO

"AAA" R03 1,5V

**51258** 0,15€

0.01	60	2400	134400

PARA REF. 51325, 51326, 51829, 52233, 51001, 52582, 52555, 52556, 52557, 52558, 52584



x3

PILHA QUADRADA 9V

**10923** 1,10€

0.05	10	500	-

PARA REF. 52162, 52450, 51929, 50942



## FOCO LED DE 50W

**53505** 77,00€

2.50 - 8 96  
Kg SUB ITT



## TRIPÉ PARA FOCO LED REF. 53505

**53506** 36,00€

2.40 - 8 96  
Kg SUB ITT



**52254** 64,00€

3.51 - 4 24  
Kg SUB ITT



- Foco não incluído.

↑ 2.770mm  
↓ 1.290mm

## ALINHADOR DE FARÓIS COM LUXÓMETRO

**52740** 690,00€

24.00 - 1 11  
Kg SUB ITT

HALÓGENO / XENON / LED

- Distância de medição: 50cm.
- Fácil medição de desvio do eixo óptico dos médios e dos máximos.
- Guias laterais opcionais.
- Também para caminhões.



CE

## ALINHADOR DE FARÓIS COM DUPLO LASER E LUXÓMETRO

**52836** 1.100,00€

24.85 - 1 10  
Kg SUB ITT

- Também para caminhões.

HALÓGENO / XENON / LED

REGULAMENTO ECRÃ DE VERIFICAÇÃO

LUXÓMETRO DIGITAL



DUPLO LASER

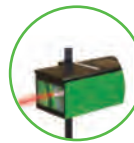

↑ 270mm  
← 520mm  
↑ 1560mm

CE

## CARREGADOR DE ISQUEIRO E TOMADA CORRENTE

REF.	DESCRIÇÃO	PARA	Kg	Sub	IT	
11107	CARREGADOR ISQUEIRO 100-240V OUTPUT: 6V 500mA	54122, 54123, 54124, 51889, 52883, 53568	0,06	1	250	4,50€
10961	TOMA DE CORRENTE 100-240V OUTPUT: 6V 500mA	54122, 54123, 54124, 51889, 52883, 53568, 53569	0,08	-	150	13,00€
11989	CARREGADOR ISQUEIRO 100-240V OUTPUT: 9V 500mA	52536	0,04	-	200	2,00€
11093	CARREGADOR ISQUEIRO 230V OUTPUT: 6V 500mA	52002	0,06	-	250	4,00€
14031	ADAPTADOR USB PARA TOMADA DE PAREDE ENTRADA: 100-240V SAÍDA: 5V 1000mA	54122, 54123, 54124, 53216, 53217, 53519, 52987, 52883, 53530, 53451, 53570, 53707, 53439, 53568, 53569	0,1	10	100	7,90€
13839	ADAPTADOR USB PARA TOMADA DE PAREDE 110V/60HZ	54122, 54123, 54124, 54216, 53217, 53519, 52987, 52883, 53530, 53451, 53570, 53707, 53439, 53568, 53569	0,04	-	200	8,50€
14032	ADAPTADOR USB PARA TOMADA DE ISQUEIRO ENTRADA: 12-24V SAÍDA: 5V, 1A/2,1A	53465, 53466, 53467, 53216, 53217, 53519, 52987, 52883, 53530, 53451, 53570, 53707, 53439, 53568, 53569	0,1	10	100	12,00€
14033	CABLE USB LONGITUD: 80CM	53216, 53217, 53519, 52987, 53530, 53451, 53570, 53707, 53499	0,1	10	100	4,50€
16052	CABO USB TIPO A / JACK REDONDO 3.5MM	54172, 54173	0,1	10	100	2,09€
16053	CABO USB TIPO A / JACK REDONDO 3.5MM	54173	0,1	10	100	2,85€





## LÂMPADA LED COM SUPORTE MAGNÉTICO

54270 42,00€

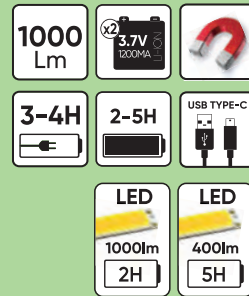
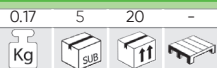

## BARRA LED MAGNÉTICA COM CORREIA PARA O CAPÔ

54271 54,00€

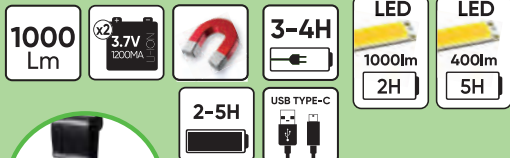
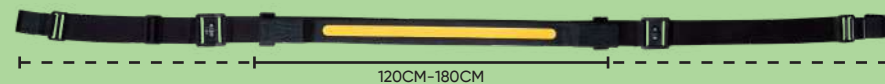
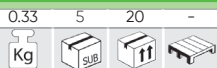

## LÂMPADA LED COM SUPORTE MAGNÉTICO

53707 153,00€



**MULTIUSO**  
COM SUPORTE MAGNÉTICO PARA DE ADAPTAR A QUALQUER SITUAÇÃO

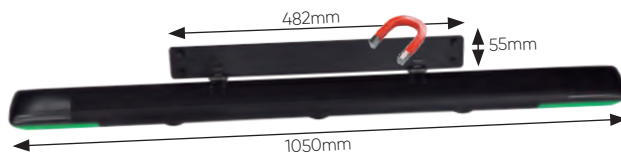

**3 MODOS DE LUZ**

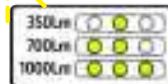

PERMITE DIRECIONAR O FOCO DE LUZ INDIVIDUALMENTE DONDE SEJA NECESSÁRIO



LUZES INDICADORAS DO ESTADO DA BATERIA

BATERIA RECARREGÁVEL



AUMENTAR SIGNIFICATIVAMENTE A VISIBILIDADE NA ÁREA DE TRABALHO.

## LÂMPADA DE INSPEÇÃO DA COBERTURA DO MOTOR COM BRAÇOS EXTENSÍVEIS

53570 154,00€



BRAÇOS EXTENSÍVEIS DE 117CM A 175CM



PERMITE DIRECIONAR O FOCO DE LUZ INDIVIDUALMENTE DONDE SEJA NECESSÁRIO



LUZES INDICADORAS DO ESTADO DA BATERIA

BATERIA RECARREGÁVEL



**3 MODOS DE LUZ**

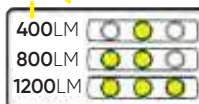

AUMENTAR SIGNIFICATIVAMENTE A VISIBILIDADE NA ÁREA DE TRABALHO



## LÂMPADA LED INDUSTRIAL

54039 154,00€

Ø :50cm x 38cm

2.60 - 1 14



Projetado especificamente para iluminar instalações industriais, oficinas e edifícios altos.

- Baixo peso
- Potência: 200W
- Fluxo luminoso: 20.000 lm
- Diâmetro: 50 x 38 cm
- Grau de proteção: IP20

- LEDs: MTC
- Driver: Meanwell
- Temperatura de cor: 6.500 K
- Frequência: 50/60 Hz



20.000Lm



CAPA DE REPOSIÇÃO

15385 18,00€

50



## CONJUNTO DE 6 LÂMPADAS INDUSTRIAIS LED

54133 547,00€

12.10 - 6 6

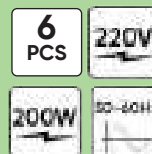

20.000Lm

## LÂMPADA LED INDUSTRIAL

54088 132,00€

Ø :29,9cm x 14,7cm

2.50 - 1 63

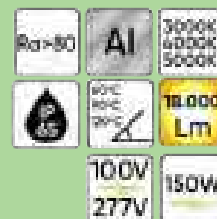
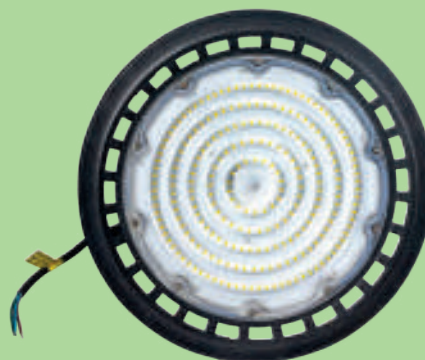

## LUZ DE EMERGÊNCIA LED MAGNÉTICO

53691 36,00€

0.70 - 20 320



- Funções:
- Função 1: FLASCH
- Função 2: DUPLO
- Função 3: ROTAÇÃO



12V 19W

100mm 139mm 4m

x36 LED



ECE R65 ECE R10

## LUZ DE EMERGÊNCIA LED 12-24V BASE FLEXÍVEL

53690 34,00€

0.55 - 20 200



- Funções:
- Função 1: FLASCH
- Função 2: DUPLO
- Função 3: ROTAÇÃO



12V 19W x36 LED

100mm 125mm



ECE R10 ECE R65



## LUZ DE EMERGÊNCIA LED RECARREGÁVEL COM BASE MAGNÉTICA

54173 87,00€

0,75 5 20 240



- Funções:
- Função 1: FLASCH
- Função 2: DUPLO
- Função 3: ROTAÇÃO

CABO USB TIPO A / JACK REDONDO 5.5MM

16053 2,85€



Alimentado a bateria recarregável  
Rechargeable battery powered.

Aprovado ECE R10/R65



ECE R65



## LUZ DE EMERGÊNCIA RECARREGÁVEL BASE FLEXÍVEL

54172 81,00€

0,80 5 20 240



- Funções:
- Função 1: FLASCH
- Função 2: DUPLO
- Função 3: ROTAÇÃO

CABO USB TIPO A / JACK REDONDO 3.5MM

16052 2,09€



Alimentado a bateria recarregável  
Rechargeable battery powered.

Aprovado ECE R10/R65



ECE R65



## LUZ DE EMERGÊNCIA LED 12-24V BASE FLEXÍVEL

52456 36,00€

0,60 - 20 160



- Lente PC.
- Tulipa anti-rotura.
- Consumo: 8W.

- Funções:
- Função 1: ROTAÇÃO
- Função 2: DUPLO FLASH
- Função 3: 6 FLASH

LED 6 EN 1

ABS - BAES

Ø 24mm

12-24V

240mm

Ø 128mm



BASE FLEXÍVEL

ECE R10

## LUZ DE EMERGÊNCIA LED 12-24V - MODULO P/PISCAR LED

52375 38,00€

0,70 - 20 240



- Lente ABS-BAES.
- Tulipa anti-rotura.
- Cabo: Aspiral de 2,5m + tomada de isqueiro.
- Consumo: 9W.

- Funções:
- Função 1: ROTAÇÃO
- Função 2: DUPLO FLASH
- Função 3: 6 FLASH

LED 6 EN 1

12-24V

170mm

Ø 140mm



ECE R10

## LUZ DE EMERGÊNCIA BASE FLEXÍVEL

51964 28,00€

0,65 - 20 160



12V  
55W

51965 29,50€

0,68 - 20 160



24V  
70W

Ø 128mm

240mm

ECE R10

ECE R65

PC



- Cúpula anti-chock.
- Lente PC.
- Fio da lente com soldadura de durabilidade.
- Rpm: 40.
- Sistema de pinhão / Senfim.
- Lâmpada:
- H1, 12V 55W
- H1, 24V 70W
- Com base de rosca.
- Consumo de corrente: 3.0 Amp.

BASE FLEXÍVEL



ABS - BAES

## LUZ DE EMERGÊNCIA SEM CABO

51962 25,00€

0,57 - 20 240



12V  
55W

51963 29,00€

0,55 - 20 240



24V  
70W

Ø 140mm

155mm

ECE R10

ECE R65



- Lente ABS - BAES.
- Tulipas anti-rotura.
- Fio da lente com soldadura de durabilidade.
- Rpm: 40.
- Sistema de pinhão / Senfim.
- Lâmpada:
- H1, 12V 55W
- H1, 24V 70W
- Consumo de corrente: 3.0 A.



## LUZ DE EMERGÊNCIA COM CABO IMANTADO

**51960** 34,00€

0.75 - 20 240



**12V**  
**55W**



170mm  
Ø 140mm

**51961** 34,00€

0.78 - 20 240



**24V**  
**70W**



- Lente ABS - BAES.
- Tulipas anti-rotura.
- Filo da lente com soldadura de durabilidade.
- Rpm: 40.
- Sistema de pinhão / Senfím.
- Lâmpada: H1, 12V 55W / H1, 24V 70W
- Cabo: Aspiral de 3m + tomada de isqueiro.
- Consumo de corrente: 3.0 A.

ECE R10  
ECE R65  
CE

## LUZ DE EMERGÊNCIA TIPO FLASH

**51966** 18,00€

0.31 - 50 800



**12V**  
**110V**

131mm  
Ø 99mm  
Ø 61mm

- Lente ABS - BAES.
- XENON.
- Consumo de corrente: 3.0 A.

BASE TULIPA ROSCADA



ECE R10  
CE

## LUZ DE EMERGÊNCIA TIPO FLASH DE LEDS PERFIL BAIXO

**52827** 46,00€

0.50 - 20 400



**52910** 39,00€

0.50 - 20 320



**52828** 43,00€

0.54 - 20 320



CE ECE R10

- Com 3 interruptores de função.
- 3 modos piscar: Rotação, 6 Flashes, Duplo Flash



## LÂMPADAS DE RECAMBIO

PARA REF. 51966

**11103** 6,00€

0.01 - 100 -



PARA REF. 51960, 51962, 51964

**10766** 1,59€

0.01 - 200 -



CÚPULA ANTI-SHOCK.

**51969** 14,00€

0.12 - 50 1000



120mm  
Ø 128mm

**11325** 17,50€

0.12 - 50 451



**11324** 17,50€

0.13 - 100 -



## CONECTORES PARA LUZ DE EMERGÊNCIA

PARA REF. 51964, 51965, 52300, 52456, 52549, 53131

**10750** 13,00€

0.25 - 50 -



PARA REF. 51964, 51965, 52300, 52456, 52549, 53131

**10751** 15,00€

0.30 - 50 -



## CABO EXTENSÍVEL MULTIFUNÇÃO

**52843** 31,60€

0.90 - 20 1500

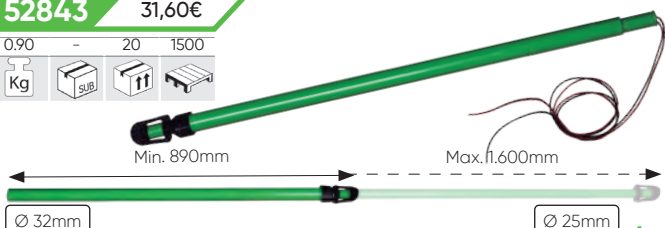

124

JBM

www.jbmcamp.com

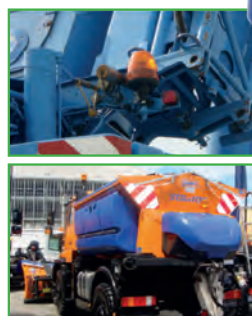

IVA não incluído



# SIRENA ACÚSTICO 12V-80V

**51967** 16,00€

0,20	10	50	1200
Kg	Sub	ff	ff



**51968** 16,00€

0,23	10	50	1000
Kg	Sub	ff	ff



**51967**

**51968**

- 107 dB.
- Resistente a diversas condições climáticas.
- Possibilidade de ser lavado com água a pressão.

- Protegido frente a polaridades inversas.
- Soldado com resinas ipoxy.
- Temperaturas suportadas: de -30 a 70°C.

# LUZ DE SEGURANÇA PARA EMPILHADEIRA

**54078** 68,00€

0,66	-	20	200
Kg	Sub	ff	ff



Luz de segurança oval com 2 LEDs azuis. A luz é projetada no solo com uma luz azul direcional como um aviso para pedestres na área.

Esta luz de aviso permite evitar colisões e acidentes entre empilhadores e pessoas, e aumenta a segurança em condições de trabalho, especialmente em pontos cegos. Perfeito para ambientes ruidosos.

Suporte universal

# FOCO AUXILIAR LED LUZ DISPERSA

**53428** 18,00€

0,50	5	20	480
Kg	Sub	ff	ff



**52566** 28,00€

1,00	-	10	360
Kg	Sub	ff	ff



**53429** 18,00€

0,40	5	20	480
Kg	Sub	ff	ff

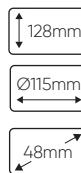

**52567** 29,00€

0,90	-	10	400
Kg	Sub	ff	ff

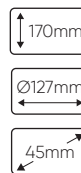

**52302** 25,40€

0,80	5	20	480
Kg	Sub	ff	ff



**53049** 89,00€

1,53	-	10	468
Kg	Sub	ff	ff



# FOCO AUXILIAR LED LUZ DISPERSA

**52303** 26,40€

0,76 5 20 640



**1.450 Lm** x9 LED 3W

Al 10-40V 27W IP 68 +30.000h



140mm  
45mm  
Ø123mm

**53052** 158,00€

2,65 - 6 144



**7.200 Lm** x8 LED 10W

Al 9-36V 80W IP 68 +30.000h



191,5mm  
Ø165mm  
98mm

**53045** 35,00€

1,00 - 12 480



**2.880 Lm** x16 LED 3W

Al 9-36V 46W IP 68 +30.000h



55mm  
127mm  
155mm

**53046** 39,00€

0,74 - 12 480



**2.272 Lm** x16 LED 1,5W

Al 9-36V 24W IP 68 +30.000h



139mm  
128mm  
48,5mm

# FOCO AUXILIAR LED LUZ CONCENTRADA

**52568** 28,00€

0,75 - 10 400



**1.450 Lm** x9 LED 3W 10V 40V

+30.000h IP 68 Al



165mm  
117mm  
45mm

**53048** 89,00€

1,50 - 10 1000



**3.600 Lm** x4 LED 10W

Al 9-36V 40W IP 68 +30.000h



87mm  
123mm  
118mm

**52569** 28,00€

0,70 5 20 320



**1.450 Lm** x9 LED 3W 10V 40V

+30.000h IP 68 Al



170mm  
Ø127mm  
45mm

**53051** 158,00€

2,75 - 6 468



**7.200 Lm** x8 LED 10W

Al 9-36V 80W IP 68 +30.000h



191,5mm  
Ø165mm  
98mm

**52415** 19,00€

0,60 5 20 480



**1.450 Lm** x9 LED 3W 10V 40V

+30.000h IP 68 Al



128mm  
110mm  
50mm

**53047** 330,00€

3,51 - 4 40



**3.200 Lm** x10 LED 5W

Al 12-24V 80W IP 67 +30.000h



230mm  
150mm  
185mm

**52414** 19,00€

0,55 5 20 480



**1.450 Lm** x9 LED 3W 10V 40V

+30.000h IP 68 Al



128mm  
Ø110mm  
50mm



DISTÂNCIA REMOTA 100M



VELOCIDADE AJUSTÁVEL DE MOVIMENTO



GIRATÓRIO



## BARRA DE SINALIZAÇÃO PARA REBOQUE COM 2 FAROLINS LED, 2 TRIÂNGULOS

**54163** 80,00€

1.85 - 6 54

Kg SUB 11 11

x42 LED 12V 24V 7.5m 7PIN IP 65

140mm 110mm

- 4 funções:  
Posição e matrícula.  
Luz de freio.  
Parpadeante.  
Massa.

Regulamento	Homologação
3	E9*3R02/17*23444*00
4	E9*4R00/19*23444*00
6	E9*6R01/29*23444*00
7	E9*7R02/27*23444*00
10	E9*10R06/00*22232*02

## KIT MAGNÉTICO COM 2 FAROLINS, 2 TRIÂNGULOS REFLECTORES LED

**54162** 81,00€

1.50 - 6 144

Kg SUB 11 11

x42 LED 12V 24V 2.5m IP 65 7.5m 7PIN

- 4 funções:  
Posição e matrícula.  
Luz de freio.  
Parpadeante.  
Massa.

Aprovado E9\*7R02/27\*23444\*00

93mm 58mm 118mm

## BARRA SINALIZAÇÃO PARA REBOQUES DE 1,4 A 2.1M

**54161** 90,00€

2.75 - 6 48

Kg SUB 11 11

x42 LED 12V 24V 7.5m 7PIN IP 65

1,4-2,1m

- 4 funções:  
Posição e matrícula.  
Luz de freio.  
Parpadeante.  
Massa.

Regulamento	Homologação
3	E9*3R02/17*23444*00
4	E9*4R00/19*23444*00
6	E9*6R01/29*23444*00
7	E9*7R02/27*23444*00
10	E9*10R06/00*22232*02

Aprovado E9\*7R02/27\*23444\*00

## CONJUNTO DE DUAS LUZES TRASEIRAS MAGNÉTICAS SEM FIO

**54044** 99,00€

1.15 - 6 168

Kg SUB 11 11

2.4 GHz -30°C 50°C WIRELESS

2-3H 10H

IP65 20m 12V 24V

7 PINS

Carregador USB

Transmissor

35mm 108mm 98mm

1m Cabo de carregamento

Aprovado E9\*178R00\*1448 E9\*150R00\*1448

## SINALIZADOR LED PARA BARRA DE REBOQUE

**53151** 14,00€

0.20 5 20 900

Kg SUB 11 11

99mm 100mm 12V 39mm

- 4 funções:  
Azul: Posição e matrícula.  
Vermelho: luz de freio.  
Amarelo: Parpadeante.  
Branco: Massa.

## SINALIZADOR LED PARA BARRA DE REBOQUE

**54160R** 17,50€ **54160L** 17,50€

0.20 5 20 880

Kg SUB 11 11

12V 24V x42 LED IP 65

DIREITO ESQUERDO

93mm 118mm 93mm 46mm

- 4 funções:  
Preto: Posição e matrícula.  
Vermelho: luz de freio.  
Verde: Parpadeante.  
Branco: Massa.

Aprovado E9\*7R02/27\*23444\*00

## BARRA DE SINALIZAÇÃO PARA REBOQUE

DE 1,4 A 2,1m CABO DE 6m

**52458** 58,00€

2,60 - 6 48

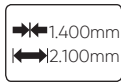

REFLETOR TRIANGULAR PARA REF.52458, 52848, 52838, 50810, 51886, 52839

**16158** 9,00€

6M

**52848** 88,00€

2,49 - 6 36



REFLETOR TRIANGULAR PARA REF.52458, 52848, 52838, 50810, 51886, 52839

**16158** 9,00€



6M

Aprovado E4 7R-0218756

## BARRA DE SINALIZAÇÃO PARA REBOQUE

2 FAROLINS, 2 TRIÂNGULOS REFLECTORES CABO DE 5m

**50910** 45,00€

1,90 - 6 54



Aprovado E4 7R-0218756

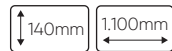

Material: HDPE

- 4 funções:

Azul: Posição e matrícula.  
Vermelho: luz de freio.  
Amarelo: Parpadeante.  
Branco: Massa.

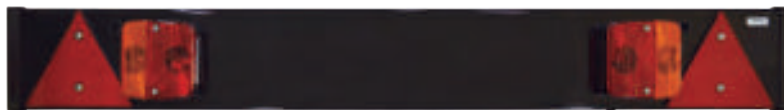

**52838** 56,00€

1,85 - 6 54



REFLETOR TRIANGULAR PARA REF.52458, 52848, 52838, 50810, 51886, 52839

**16158** 9,00€



## KIT MAGNÉTICO COM 2 FAROLINS 2 TRIÂNGULOS REFLECTORES

**51886** 44,00€

1,50 - 8 120



Cabo liso: 7m  
Cabo espiral: 2,5m

**52839** 64,00€

1,47 - 8 128



Aprovado E4-7R-0218756

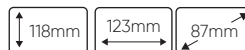

LED



**16158** 9,00€

REFLETOR TRIANGULAR PARA REF.52458, 52848, 52838, 50810, 51886, 52839





## COMPROVADOR DE LUZES DE REBOQUE 7/13 PINOS

**53536** 34,00€

0,40	4	24	432
Kg	sub	ff	tr



**7-13**  
pinos

**9V**



EXTENSÃO  
DE 7 PINOS

- Este testador tem um soquete de 13 pinos em cada extremidade para ser conectado ao reboque e ao plugue do carro.
- Ele indica rapidamente se há danos na fiação do carro e do trailer.
- Também é útil para verificar caravanas e suportes de bicicletas.

- Tem duas saídas, uma para a saída do veículo e outra para a entrada do reboque.
- Inclui um adaptador de 13 a 7 pinos.
- PILA 9V.



13 PINOS

7 PINOS

**14753** 13,00€

0,20	-	50	-
Kg	sub	ff	tr

- Ficha de 7 pinos e tomada de 7 pinos
- Tamanho do cabo: 20cm x 0,5mm<sup>2</sup>

## COMPROVADOR DE LUZES DE REBOQUE 7 PINOS

**51929** 22,00€

0,90	4	24	1144
Kg	sub	ff	tr

**7**  
pinos

**9V**



- Este comprobador têm uma toma em um lado para conectar el enchufe de 7 pinos do reboque e no outro para conectar a tomada a 7 pinos do carro.
- Este comprobador indica rápidamente si há estragos nos cabos tanto do carro como do reboque.

- Também útil para a comprovação de caravanas e suportes para bicicletas.
- Dispoe de duas saídas, uma para a tomada de saída del veículo e outra para a tomada de entrada de reboque.



TOMADA REBOQUE



TOMADA VEÍCULO



## MINI ESTOJO DE LÂMPADA

12V H9



**12V**

**51615** 5,95€

0,09	10	100	1500
Kg	sub	ff	tr

12V H11



**12V**

**51612** 5,95€

0,09	10	100	1500
Kg	sub	ff	tr

12 V HB3



**12V**

**50523** 4,70€

0,09	10	100	1500
Kg	sub	ff	tr

12V HB4



**12V**

**50524** 4,70€

0,09	10	100	1500
Kg	sub	ff	tr

12V H7+H1



**12V**

**50915** 4,20€

0,10	10	100	1800
Kg	sub	ff	tr

12 V H1



**12V**

**51613** 2,90€

0,90	10	100	1500
Kg	sub	ff	tr

H4



**51614** 3,60€

0,10	10	100	1800
Kg	sub	ff	tr

**12V**

**52047** 3,30€

0,09	10	100	1500
Kg	sub	ff	tr

**24V**

H7



**50431** 3,80€

0,08	10	100	1800
Kg	sub	ff	tr

**12V**

**52048** 3,95€

0,10	10	100	1500
Kg	sub	ff	tr

**24V**

# ARMÁRIO DE LÂMPADAS PARA TURISMOS

**50551** 350,00€

560mm 650mm

9,39	-	1	14
Kg	sub	ff	

## Stop de 1 Polo

P21W 21 W BA15s 30u.  
P21WA 21 W BA15s Ambar / 10u.  
PY21W 21 W BAU15s  
Com desc. / 10u.

## Stop de 2 Polos

R21/5 W 21/5 W BAY15d 40u.  
PLAFONIER  
C5W 5 W SV8.5 11x38 22u.

## Lâmpadas Halógenas

H1 55 W P14,5s 10u.  
H2 55 W X511 4u.  
H3 55 W PK22s 4u.  
H4 60/55 W P43t 10u.  
H7 55 W PX26d 10u.  
HB3 65 W P20d 4u.  
HB4 55 W P20d 4u.  
H9 65 W PGJ19-5 4u.  
H11 65 W PGJ19-2 4u.

## Lâmpadas Piloto

R5W 5 W BA15s 30u.  
R10W 10 W BA15s 30u.

## Foco Europeu

T5 1,2 W W2,1x4,6d 20u.  
T10 5 W W2,1x9,6d 12u.  
T10 3 W W2,1x9,6d 12u.  
T13 10 W W2,1x9,6d 10u.  
T15 18 W W2,1x9,6d 10u.  
T20 21 W W5x16d 10u.  
T20A 21 W W5x16d Ambar 10u.  
T20 21/5 W W5x16d 10u.

## Lâmpadas indicadoras

T4W 4 W BA9s 22u.

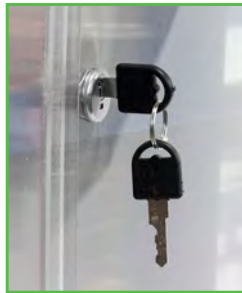

# LÂMPADAS OBN

H7	H4	H1	H1 55W	H3	BA15S	2 POLOS
<b>52365</b> 2,46€	<b>52364</b> 2,86€	<b>52362</b> 1,23€	<b>10766</b> 1,59€	<b>52363</b> 1,23€	<b>53203</b> 0,46€	<b>52369</b> 1,19€
0,02 10 200 9000	0,02 10 200 4400	0,01 10 200 14400	0,01 - 200 -	0,02 10 200 14400	0,01 10 200 -	0,01 10 1000 18000
Kg sub ff	Kg sub ff	Kg sub ff	Kg sub ff	Kg sub ff	Kg sub ff	Kg sub ff
12V 55W	12V 60-55W	12V 55W	12V 55W	12V 55W	12V 21W	12V 21-55W
- Empaque: Caixa 1pcs	- Empaque: Caixa 1pcs	- Empaque: Caixa 1pcs	- Empaque: Caixa 1pcs	- Empaque: Caixa 1pcs	AMBER	- Empaque: Caixa 10pcs. - Sem casquilho T20
T20A	R5W	WEDGE T20	T20	T20	T13	T15
<b>52368</b> 1,14€	<b>53007</b> 0,42€	<b>52862</b> 1,15€	<b>52370</b> 1,17€	<b>52864</b> 1,20€	<b>52865</b> 0,50€	<b>52866</b> 0,25€
0,01 10 1000 18000	0,05 10 200 1500	0,01 10 1000 1500	0,01 10 1000 18000	0,01 10 500 1500	0,01 10 2000 -	0,01 10 2000 25000
Kg sub ff	Kg sub ff	Kg sub ff	Kg sub ff	Kg sub ff	Kg sub ff	Kg sub ff
12V 21W	5V 12V	12V 21W	12V 21W	12V 21/5W	12V 10W	12V 18W
- Empaque: Caixa 10pcs. - Sem Casquilho	- Empaque: Caixa 10pcs - Casquilho BA15S	- Empaque: Caixa 10pcs - W3x16d	- Empaque: Caixa 10pcs. - Sem Casquilho	- Empaque: Caixa 10pcs - W3x16q	- Empaque: Caixa 10pcs - Sem casquilho	- Empaque: Caixa 10pcs - Casquilho

LÂMPADAS DE VEÍCULOS





## **FERRAMENTAS PNEUMATICAS**

- 132 PISTOLAS DE IMPACTO
- 134 PARA CAMINHÕES
- 135 BERNEQUINS/ROQUETES
- 136 MÁQUINAS DE CORTE / KIT DE POLIMENTO
- 137 REBARBADORAS
- 138 DESTANOLADOR PNEUMÁTICO  
/ RODA VÁLVULAS
- 139 LIXADEIRA ORBITAL / POLIDORES
- 141 MARTELOS PNEUMÁTICOS
- 142 DISCOS DE CORTE / DISPLAYS
- 143 PISTOLA DE INFLAR / DPF
- 144 FILTROS DE AR / ÓLEOS LUBRIFICANTES
- 145 PISTOLAS DIVERSAS
- 146 ENROLADOR DE MANGUEIRA DE AR
- 147 MANGUEIRAS DE AR / CONECTORES
- 147 ADAPTADORES / ENGATES

## PISTOLA DE IMPACTO 1/2" COMPOSITE

53520 228,00€

1756Nm

COMPOSITE

2.40	5	10	160
Kg	Sub	ft	mm



1/2"	MAX 1756 Nm	3000 RPM
34-624 Nm	1,9kg	1/4"
83-112 Nm	113 L/min	
83 dBa	183mm	x3 SPEED

KIT DE REPARAÇÃO PARA PISTOLA 53520

14121 26,00€

0.75	-	20	-
Kg	Sub	ft	mm



## PISTOLA DE IMPACTO MODELO NANO 1/2"

53588 164,00€

1302Nm

1.65	-	5	385
Kg	Sub	ft	mm

1/2"	MAX 1302 Nm	10,000 RPM
34-624 Nm	1,44kg	1/4"
90 PSI	4 CFM	



KIT DE REPARAÇÃO PARA PISTOLA 53588

14165 26,50€

0.05	-	20	-
Kg	Sub	ft	mm



## PISTOLA DE IMPACTO MINI DE 1/2" COMPOSITE

51206 228,00€

COMPOSITE

1302Nm

1.46	5	10	300
Kg	Sub	ft	mm

1/2"	MAX 1302 Nm	3,000 RPM
34-624 Nm	1,2kg	1/4"
83-112 Nm	112 L/min	
83 dBa	x3 SPEED	



KIT DE REPARAÇÃO PARA PISTOLA 51206

14120 22,00€

0.15	-	5	-
Kg	Sub	ft	mm



## PISTOLA DE IMPACTO 1/2"

53733 238,00€

650Nm

1.30	5	10	280
Kg	Sub	ft	mm

1/2"	MAX 650 Nm	
8,500 RPM 850 Nm	8,500 RPM 650 Nm	27-231 Nm
1,16kg	90 PSI 4 CFM	1/4"
113 L/min	x4 SPEED	



KIT DE REPARAÇÃO PARA PISTOLA 53733

14633 22,50€

0.03	-	20	-
Kg	Sub	ft	mm

## PISTOLA DE IMPACTO 1/2"

53608 98,00€

1200Nm

2.35	5	10	300
Kg	Sub	ft	mm



1/2"	MAX 1200 Nm	
7,500 RPM	80-225 Nm	2kg
90 PSI 6,5 CFM	1/4"	183,9 L/min
x4 SPEED	107,4 dBa	



KIT DE REPARAÇÃO PARA PISTOLA 53608

14583 6,00€

0.01	-	20	-
Kg	Sub	ft	mm



## PISTOLA DE IMPACTO 1/2" COMPOSITE

53689 238,00€

2.10 5 10 140



COMPOSITE



KIT DE REPARAÇÃO PARA PISTOLA 53689

14618 19,00€



VELOCIDADE E POTÊNCIA AJUSTÁVEIS COM UMA SÓ MÃO

## PISTOLA DE IMPACTO 1/2"

53726 128,00€

2.35 - 10 240



KIT DE REPARAÇÃO PARA PISTOLA 53726

15564 11,90€



## PISTOLA DE IMPACTO DE 3/4" + ALARGADOR 15cm COMPOSITE

51210 650,00€

4.49 - 4 60



COMPOSITE

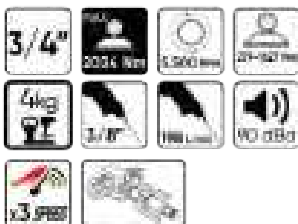

KIT DE REPARAÇÃO PARA PISTOLA 51210

14122 34,00€



## PISTOLA DE IMPACTO DE 1" + ALARGADOR 12cm COMPOSITE

51213 690,00€

4.93 - 4 60



COMPOSITE

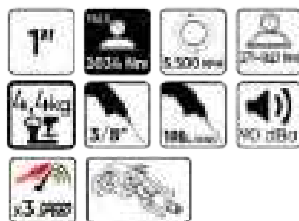

KIT DE REPARAÇÃO PARA PISTOLA 51213

14123 33,00€



## PISTOLA DE IMPACTO DE 3/4" COMPOSITE

51212 488,00€

3.77 - 4 128



COMPOSITE



KIT DE REPARAÇÃO PARA PISTOLA 51212

14122 34,00€



## PISTOLA DE IMPACTO DE 1" COMPOSITE

51211 560,00€

3.86 - 4 60



COMPOSITE



KIT DE REPARAÇÃO PARA PISTOLA 51211

14123 33,00€



JBM RECOMENDA O USO DE SEUS ÓLEOS LUBRIFICANTES PARA OTIMIZAR O DESEMPENHO E AMPLIAR A VIDA ÚTIL DA FERRAMENTA

EM PAG.144

14534 600ML



14560 100ML



# PISTOLA PNEUMÁTICA PARA RODA DE CAMINHÃO 1"

52814 528,00€

3260Nm

22,25	-	1	24
Kg	sub	ft	ft

- Saída de ar lateral.
- Fácil de aperto e afrouzamento
- regulação de velocidade.

670mm



1"	MAX 3260 Nm	3.600 rpm	18,5kg
424 L/min	1/2"	6 bar	90 PSI 18 CFM
x6 SPEED	111 dB	25 m³/h	



KIT DE REPARAÇÃO PARA PISTOLA 52814

14153 20,50€

0,05	-	15	-
Kg	sub	ft	ft



# CHAVE DE IMPACTO PARA CAMINHÕES 1" - ULTRA LIGEIRA

53681 743,00€

2441Nm

798	-	2	50
Kg	sub	ft	ft

522mm

1"	MAX 2441 Nm	4.000 rpm	7,1kg
90 PSI 10 CFM	6.3 bar	1/2"	282 L/min
90 dBA	185mm	522mm	



KIT DE REPARAÇÃO PARA PISTOLA 53681

14336 58,00€

1,17	10	10	-
Kg	sub	ft	ft

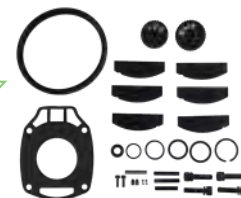

# PISTOLA DE IMPACTO DE 1/2" DOBLE BLISTER

51222 128,00€

101Nm

1,09	-	20	240
Kg	sub	ft	ft

1/2"	MAX 101 Nm	1000-1800 rpm	0,9kg
7-60 Nm	6.3 bar	360°	
1/4"			



KIT DE REPARAÇÃO PARA PISTOLA 51222

14131 24,00€

0,01	-	10	-
Kg	sub	ft	ft



MECANISMO "BORBOLETA"

# MAQUINA DE FURAR ÂNGULO 90° 3/8"

51221 199,00€

1,27	-	10	120
Kg	sub	ft	ft

- Reversível de ambos lados.
- Acabado em borracha.

3/8"	1.500 rpm	1,2kg
1/4"	113 L/min	90°
85 dBA	3/8"	



KIT DE REPARAÇÃO PARA PISTOLA 51221

14130 21,00€

0,01	-	10	-
Kg	sub	ft	ft





## KIT ROQUETE MULTI-FUNÇÃO 1/4" DE CABEÇA ABERTA COMPOSITE

51225 198,00€

0,89	5	10	120
Kg	Sub	ft	mm

- Kit Contém:  
Peça convertidora de 1/4" a 3/8".  
Cabeça para Pontas de 1/4".  
Kit 2 pontas lisas + 2 Pontas estrela.

COMPOSITE

40,7Nm



KIT DE REPARAÇÃO PARA PISTOLA 51225

14132 21,50€

0,01	-	10	-
Kg	Sub	ft	mm



## BERBEQUIM 1/2" COMPOSITE

51220 240,00€

1,64	-	10	120
Kg	Sub	ft	mm

- Reversível de ambos lados.



COMPOSITE



KIT DE REPARAÇÃO PARA PISTOLA 51220

14129 12,50€

0,01	-	10	-
Kg	Sub	ft	mm



## ROQUETE MINI DE 1/2" COMPOSITE

53784 148,00€

0,55	5	20	1200
Kg	Sub	ft	mm

COMPOSITE



133mm

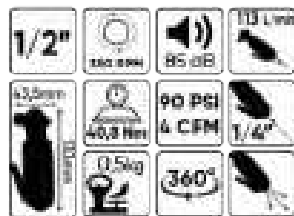

KIT DE REPARAÇÃO PARA PISTOLA 53784

14779 33,00€

0,05	-	10	-
Kg	Sub	ft	mm



## ROQUETE MINI DE 1/4" COMPOSITE

51214 148,00€

0,55	5	20	-
Kg	Sub	ft	mm

COMPOSITE



133mm



KIT DE REPARAÇÃO PARA PISTOLA 51214

14124 20,50€

0,25	-	10	-
Kg	Sub	ft	mm



## ROQUETE DE 1/2"

51215 119,00€

1,55	5	20	240
Kg	Sub	ft	mm

- Rotação de ar de admissão e escape.  
- Regulador de Ar.



KIT DE REPARAÇÃO PARA PISTOLA 51215

14125 19,50€

0,33	-	10	-
Kg	Sub	ft	mm



## REBARBADORA ÂNGULAR COMPOSITE

51218 288,00€

2,27	5	10	120
Kg	Sub	ft	mm

- Acabado em borracha.  
- Maior aderência.  
- Alavanca reversível.

COMPOSITE



KIT DE REPARAÇÃO PARA PISTOLA 51218

14127 32,50€

0,01	-	10	-
Kg	Sub	ft	mm



# MÁQUINA PNEUMÁTICA P/ **MON-TAR FOLES DE TRANSMISSÕES**

**51861** 199,00€

4,00	-	2	32
Kg	Sub	ff	ff

- Material: Alumínio.
- Abertura de 20 a 100mm.

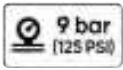

# REBARBADORA

**51219** 222,00€

2.10	5	10	120
Kg	Sub	ff	ff

- Acabado em borracha.
- Maior aderência.
- Alavanca de segurança 8 posições.

400mm

REPOSIÇÃO EM PAG. 142

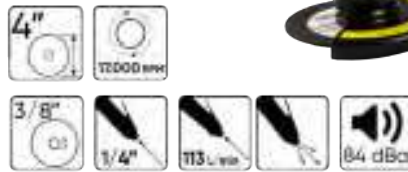

RESGUARDO ANTI CHISPAS

KIT DE REPARAÇÃO PARA 51219

**14128** 13,50€

0.01	-	10	-
Kg	Sub	ff	ff



# KIT MINI REBARBADORA

**51226** 233,00€

1.52	-	10	120
Kg	Sub	ff	ff

- Punho em borracha.
- Maior agarre.
- Designo MINI.
- Contém óculos, resguardos e discos.



KIT DE REPARAÇÃO PARA PISTOLA 51226

**14133** 16,50€

0.01	-	10	-
Kg	Sub	ff	ff

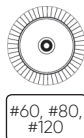

REPOSIÇÃO EM PAG. 142

# KIT REBARBADORA PNEUMÁTICA COM SAÍDA TRASEIRA

**51227** 193,00€

2.03	-	10	120
Kg	Sub	ff	ff

- Punho em borracha.
- Maior aderência.
- Designo MINI.
- Contém óculos, Palancas, allen e 10 discos de 3".



KIT DE REPARAÇÃO PARA PISTOLA 51227

**14134** 17,50€

0.01	-	10	-
Kg	Sub	ff	ff



REPOSIÇÃO EM PAG. 142

# KIT PULIDORA

**51216** 650,00€

4.33	-	4	16
Kg	Sub	ff	ff

- Proteção do Usuário de chispas.
- Adaptador (patentado).
- Cabo anatómico.
- Segurança no acelerador de resguardo.

- Contém: Distintos tipos de rodas (para a preparação de superfícies metálicas consoante o tipo de trabalho).
- 11mm - escova de arame (fino).
- 23mm - escova de arame (fino).
- 11mm - escova de arame (grosso).
- 23mm - escova de arame (grosso).

- Apagador de borracha.
- Apagador de pinturas com base de água.
- Adaptador de 23mm para apagador.
- De borracha e escova de arame.
- Adaptador de 11mm da escova de arame.
- Pulidor pedro de borracha dura (até 6 peças).
- Adaptor unico do pulidor de borracha dura.
- Adaptador de dupla tira de borracha dura.
- Allen.



19 PCS

1,2kg

CABO ANATÓMICO

## ACCESÓRIOS

### SUPORTES

Para roda de 23mm

**51439** 26,00€

0.10	-	100	800
Kg	Sub	ff	ff

Para roda de 11mm

**51440** 28,00€

0.10	-	100	800
Kg	Sub	ff	ff

Roda preta duplo

**51441** 26,00€

0.10	-	100	800
Kg	Sub	ff	ff

Roda preta simple

**51442** 28,00€

0.10	-	50	800
Kg	Sub	ff	ff

Lamelas de pintura 0105mm

**51392** 34,00€

0.20	-	100	800
Kg	Sub	ff	ff

### LAMELAS

Lamela grossa ângulo de 23mm

**51388** 22,00€

0.10	-	100	800
Kg	Sub	ff	ff

Grossa ângulo 11mm

**51389** 22,00€

0.05	-	100	800
Kg	Sub	ff	ff

Lamela fina lisa 23mm

**51390** 22,00€

0.05	-	100	800
Kg	Sub	ff	ff

Lamela fina lisa 11mm

**51391** 22,00€

0.04	-	100	800
Kg	Sub	ff	ff

Lamela de pintura com agua 0105mm

**51393** 34,00€

0.10	-	50	800
Kg	Sub	ff	ff

KIT DE REPARAÇÃO PARA PISTOLA 51216

**14126** 54,00€

0.01	-	10	-
Kg	Sub	ff	ff

# FERRAMENTA PARA BERBEQUIM - RODA VALVULAS

**54033** 49,00€

0.30	5	20	720
Kg	Sub	ff	ff

- Diâmetro ventosas: 16, 20, 30, 35, 40mm
- Conexão berbequim: 8mm
- Comprimento: 128mm
- Velocidade máxima de trabalho



# PISTOLA DE SILICONE PNEUMÁTICA

**53567** 43,00€

1.05	-	10	180
Kg	Sub	ff	ff

- Pressão de trabalho: 2,5-5 BAR.
- Entrada de ar: 1/4".
- Capacidade do cartucho: 310ml.

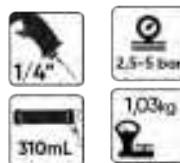



## MINI AMOLADORA DE 3/8" 6mm

51245 99,00€

0,60	-	20	240
Kg	Sub	ft	mm



KIT DE REPARAÇÃO  
PARA PISTOLA 51245

14135 12,50€

0,01	-	10	-
Kg	Sub	ft	mm



## MINI AMOLADOR 1/4"

53137 38,00€

0,55	5	20	720
Kg	Sub	ft	mm



## PISTOLA IMPACTO 3/4"

53343 285,00€

790	-	2	72
Kg	Sub	ft	mm



1600Nm



## PISTOLA IMPACTO 1"

53344 295,00€

8,05	-	2	80
Kg	Sub	ft	mm



1600Nm



## AMOLADORA PNEUMÁTICA 1/4" COMPOSITE

53141 68,00€

0,60	5	20	1120
Kg	Sub	ft	mm



## AMOLADORA ANGULAR PNEUMÁTICA

52528 49,00€

0,70	5	20	960
Kg	Sub	ft	mm



GATILHO DE SEGURANÇA  
INCORPORADO

- Corpo fabricado em alu.
- Com recubrimento de goma.
- Fácil manejo e ligero.

## SERRA PNEUMÁTICA

52574 69,00€

0,73	4	20	640
Kg	Sub	ft	mm

- 2 serras recambio 95mm - 32 dentes.
- 2 chaves ALLEN.
- 1 protetor de Serra.



5 LÂMINAS DE SERRA  
24 DENTES

11956 5,50€

0,03	10	300	-
Kg	Sub	ft	mm

5 LÂMINAS DE SERRA 32  
DENTES PARA FERRO

11957 5,50€

0,01	10	250	-
Kg	Sub	ft	mm



## MÁQUINA DE REBITES DE AR

52575 119,00€

1,75	5	10	140
Kg	Sub	ft	mm

2,4mm (3/32), 3,2mm (1/8), 4,0mm (5/32), 4,8mm (3/16)
---

- Tamanho: 3/16" - 5/32" - 1/8" - 3/32".
- Tração: 1586lbs / 720 kgs.
- Rod: 9/16" - 14mm.
- Binário max. 60FT LB / 23-69NM.
- Entrada de ar: 1/4".
- Consumo de ar médio: 0.03Cfm/0.86L/min.

- Contém:
- 2 Multi-tool
- Quick
- O-rings



## TESOURA PNEUMÁTICA METALICA

**53541** 168,00€

1.60	5	10	-
Kg	sub	ff	

- Tesoura pneumática profissional ideal para corte de alumínio, outros metais, borracha e plásticos em geral, com capacidade de corte de 1,02mm.
- Agarre de ferramenta ergonômico para uso confortável e gatilho fácil de usar.
- Permite cortar em linha reta, em ângulo ou em círculos, sem deformação das bordas.



## CORTADORA PNEUMÁTICA COMPOSITE

**53140** 98,00€

0.99	-	14	400
Kg	sub	ff	



DISCO DE SUBSTITUÇÃO PARA REF. 53140

**14013** 3,50€

0.01	-	1000	-
Kg	sub	ff	



KIT DE REPARAÇÃO PARA PISTOLA 53541

**14136** 12,00€

0.01	-	5	-
Kg	sub	ff	



## MÁQUINA PARA DESCRAVAR PONTOS SOLDADURA PNEUMÁTICA

**52724** 381,00€

2.55	-	6	84
Kg	sub	ff	

1/4"

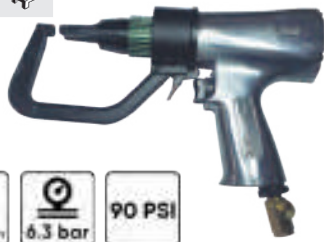

**52725** 349,00€

2.35	-	10	180
Kg	sub	ff	

1/4"



PONTA PARA REF. 52725 E 52724



**13817** 17,00€

0.10	-	500	-
Kg	sub	ff	

6,5mm

**13818** 20,50€

0.10	-	500	-
Kg	sub	ff	

8mm

## DESTALONADOR PNEUMÁTICO DE PNEUS

**53542** 980,00€

6.35	-	4	40
Kg	sub	ff	



- Destalonador de jantes pneumático profissional especialmente projetado para aplicação em veículos agrícolas, industriais e a maioria dos caminhões.
- Extremamente rápido: economiza tempo em relação aos rompedores hidráulicos convencionais.
- Permite a desmontagem in situ no local de trabalho da máquina.
- Excelente para trabalhar sobre o pneu sem retirar a roda: solta o talão do pneu da jante com alavancagem.

- As especificações técnicas:  
Capacidade de abertura: 68mm.  
Extensão do pistão: 80mm.  
Entrada de ar: 1/4".  
Consumo de ar: 113 l/min.  
Comprimento: 396mm.  
Peso: 4,6 kg.  
10.000 RPM

KIT DE REPARAÇÃO PARA PISTOLA 53542

**14137** 131,00€

0.65	5	5	-
Kg	sub	ff	



PARA APLICAÇÃO EM VEÍCULOS AGRÍCOLAS/INDUSTRIAIS



## FERRAMENTA PNEUMÁTICA POLIMENTO VÁLVULAS - PERCUSSÃO E ROTAÇÃO

**53572** 348,00€

1.90	-	5	80
Kg	sub	ff	

- Conteúdo:  
1 x máquina pneumática para válvulas.  
5 x ventosa (16, 20, 30, 35 e 45 mm).  
5 x adaptador de válvula.  
Chave Allen de 1 x 3 mm.



REGULA A VELOCIDADE

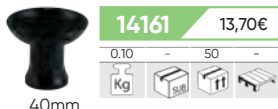
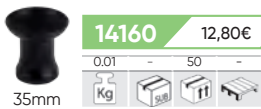

VIRAR À DIREITA + VIRAR À ESQUERDA

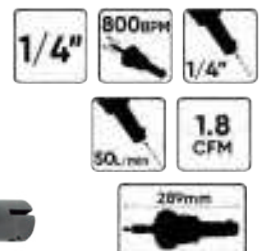



## LIXADEIRA ORBITAL AUTO-ASPIRANTE

**52676** 98,00€

1.45	5	10	80
Kg	Sub	11	11

- Corpo de alumínio com punho gomado.
- Excelente desempenho de limpeza com bolsa e mangueira.



## LIXADEIRA ORBITAL ADAPTÁVEL ASPIRADOR

**52675** 84,00€

1.25	5	10	160
Kg	Sub	11	11

**52758** 88,00€

1.33	5	10	160
Kg	Sub	11	11

200mm  
Corpo de alumínio com punho gomado



## DISCO PARA LIXADEIRAS



DISCO DE 6 BURACOS PARA 52675, 52758, 52676, 52376

**12009** 11,00€

0.14	50	-
Kg	Sub	11

Ø 150mm



DISCO DE 66 BURACOS PARA 52675, 52758, 52676, 52376

## PISTOLA DE SOPRO E ASPIRAÇÃO

**54251** 43,00€

0.63	5	20	240
Kg	Sub	11	11



## 3" CONJUNTO PARA A MINIMÁQUINA DE POLIMENTO PNEUMÁTICA

**53576** 189,00€

1.85	-	5	70
Kg	Sub	11	11

- O kit contém:
- 1x polidora pneumática de 3".
- 1x disco de lixamento de velcro (instalado).
- 1x chave para porcaa.
- 3x esponjas de polimento com reverso de velcro.



## 3" CONJUNTO PARA A MÁQUINA DE POLIMENTO PNEUMÁTICA

**53646** 62,00€

0.85	5	10	400
Kg	Sub	11	11

- O kit contém:
- 1x polidora pneumática de 3".
- 1x disco de lixamento de velcro (instalado).
- 1x chave para porcaa.
- 3x esponjas de polimento com reverso de velcro.



VELOCIDADE AJUSTÁVEL

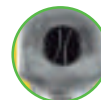

**14162** 25,50€

0.05	50	-
Kg	Sub	11

ALMOFADA DE LÃ PARA REF. 53576

**14164** 25,50€

0.50	5	50
Kg	Sub	11

ALMOFADA ESPONJOSA DURA PARA REF. 53576 - AMARELA

**14163** 25,50€

0.50	5	50
Kg	Sub	11

ALMOFADA ESPONJOSA MACIA PARA REF. 53576 - BRANCA

**14330** 3,50€

0.01	5	50
Kg	Sub	11

DISCO VELCRO PARA 53576

KIT DE REPARAÇÃO

0.05	10	-
Kg	Sub	11

**14154** 42,00€

**14286** 2,99€

0.01	200	-
Kg	Sub	11

ALMOFADA ESPONJOSA MACIA PARA REF. 53646

**14287** 2,99€

0.01	200	-
Kg	Sub	11

ALMOFADA ESPONJOSA DURA PARA REF. 53646

**14288** 6,00€

0.01	10	200
Kg	Sub	11

ALMOFADA DE LÃ PARA REF. 53646

**14289** 6,10€

0.10	200	-
Kg	Sub	11

DISCO VELCRO PARA 53646

JBM RECOMENDA O USO DE SEUS ÓLEOS LUBRIFICANTES PARA OTIMIZAR O DESEMPENHO E AMPLIAR A VIDA ÚTIL DA FERRAMENTA

EM PAG.144

**14534** 600ML



**14560** 100ML



# KIT DE RESTAURAÇÃO DE FARÓIS

**53626** 18,00€

Este kit é feito para restaurar **2** faróis.

0,30 - 12 576



Projetado para restaurar a clareza das lentes dos faróis que ficaram amareladas, nubladas ou turvas. Melhora o desempenho das lentes dos faróis. Três passos simples: lixar, polir e proteger. Restaura faróis dianteiros, lanternas, faróis de neblina ou sinais de direção.

- Conteúdo del kit:
- 2x P800 Discos de lixar.
- 2x P1200 Discos de lixar.
- 2x P2000 Discos de lixar.
- 1x 85gm Pasta de polimento.
- 2x 3.0ml Líquido protetor UV.
- 1x Fita adesiva.
- 1x Disco de polimento de lã.
- 1x Disco de Esponja Branco.
- 1x Almofada de suporte M10 Rosca.
- 2x Adaptador (3/8" & 1/4").



# KIT ESPECIAL POLIMENTO: MÁQUINA POLIMENTO NEUMÁTICA + 12 KIT RESTAURAÇÃO DE FARÓIS

**SERIE262** 199,00€

5,25 - - -



# KIT FERRAMENTAS PNEUMÁTICA

**52331** 201,00€

7,90 - 2 48



PISTOLA DE IMPACTO + MARTELO NEUMÁTICO + ROQUETE NEUMÁTICO + MINI POLIDORA NEUMÁTICA + PISTOLA DE BUFAR + PISTOLA DE BUFAR RETA



- 1x Pistola de impacto 1/2"
- 1x Martelo pneumático 150mm
- 1x Roquete pneumático 3/8"
- 1x Amoladora pneumática
- 1x Barra de retenção
- 1x Barra de extensão 1/2" - 75mm
- 1x Galheta de óleo mini
- 1x Chave hex. 4mm
- 8x Chaves de impacto: 12, 13, 17, 19, 1/2", 9/16", 5/8", 11/16"
- 1x Pistola de ar
- 1x Mini pistola de ar
- 1x Rolo de teflón
- 4x Ponteiros 120mm
- 2x Chaves fixas manuais
- 5x Disco de lixado 1/4"
- 5x Disco de lixar 1/2"
- 5x Pedras de pulir 1/4"
- 5x Pedras de pulir 3/8"
- 2x Cilindros de lizar (3/4" e 1")
- 1x Adaptador rápido fêmea
- 1x Conector de ponteiro
- 8x Pontas de bufar
- 2x Adaptadores 1/8" para lixas
- 1x Conector M-M conexão rápida
- 1x Conector rápido M-H
- 1x Boca de borracha
- 1x Boca cônica
- 1x Agulha de ar
- 1x Boca de alta pressão
- 1x Boca de segurança
- 1x Caixa de plástico

# KIT DE 16 CHAVES PNEUMÁTICAS COM PISTOLA E ROQUETE

**52156** 140,00€

5,36 - 4 112



PISTOLA DE IMPACTO:



ROQUETE PNEUMÁTICO: ADAPTADOR M / H



1/2" 16 PCS

9, 10, 11, 13, 14, 17, 19, 22, 24, 27mm

# PISTOLA DE IMPACTO DE 1/2"

**52165** 118,00€

**610Nm**

2,90 - 6 168



# ROQUETE PNEUMÁTICO DE 1/2"

**52167** 48,00€

**61Nm**

1,25 5 10 560





## MARTELO DE AGULHAS PNEUMÁTICO

**53625** 68,00€

2,15 5 10 320



- Velocidade de impacto: 4500BPM
- 19 agulhas
- Peso: 1,97kg



AGULHA PARA REF. 53625

**14188** 0,50€

0,00 50 200 -



Golpe: 43mm

## MARTILLO PNEUMÁTICO

**52718** 48,00€

1,95 4 8 144



**9**  
PCS

## BERBEQUIM REVERSÍVEL PNEUMÁTICO DE 1/2"

**52159** 64,00€

1,79 5 10 240



## BERBEQUIM PNEUMÁTICO DIRETA

**53573** 36,00€

0,75 5 20 -



- Compatível com brocas de 1,5 a 10 mm.



## BERBEQUIM PNEUMÁTICO DE 3/8"

**52160** 48,00€

1,22 5 10 400



## BERBEQUIM 3/8" ÂNGULO 90°

**52527** 82,00€

1,22 5 10 480



## KIT DE 16 PEÇAS COM AMOLADORA PNEUMÁTICA

**52157** 48,00€

0,90 5 10 240



## MINI AMOLADORA PNEUMÁTICA DE 1/4"

**52171** 39,00€

0,40 5 20 1080

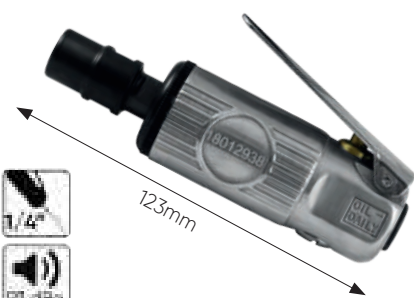

JBM RECOMENDA O USO DE SEUS ÓLEOS LUBRIFICANTES PARA OTIMIZAR O DESEMPENHO E AMPLIAR A VIDA ÚTIL DA FERRAMENTA

EM PAG.144

**14534**  
600ML



**14560**  
100ML



# CORTADOR PNEUMÁTICO 3"

**52953** 38,00€

0,90 5 20 420



**DISCO DE CORTE 3" PARA REF. 52953**

**12987** 1,50€

0,01 50 500 -



## DISCOS DE CORTE

PARA REF. 51227



**51387** 3,25€

0,03 10 300 800



Ø Interior: 9,53mm  
Ø Exterior: 75mm

**3"**

PARA REF. 51219



**51385** 4,55€

0,01 10 300 800



Ø Interior: 9,53mm  
Ø Exterior: 100mm

**4"x1/32"**

## DISCOS LIXA

PARA REF. 51218

**51386** 5,95€

0,10 - 25 800



Ø Interior: 22mm  
Ø Exterior: 125mm

**5"**



PARA REF. 51226

**51443** 5,50€

0,50 25 150 800

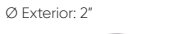

Ø Exterior: 2"

**#60**



PARA REF. 51226

**51444** 5,05€

0,02 - 25 800

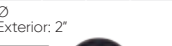

Ø Exterior: 2"

**#80**



PARA REF. 51226

**51445** 5,05€

0,02 - 25 800

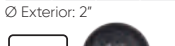

Ø Exterior: 2"

**#120**



## EXPOSITOR DE FERRAMENTA PNEUMÁTICA

**53492** 380,00€

13,00 - 1 7



EXPOSITOR SEM FERRAMENTAS

Ø 50cm



182cm

## GANCHO MAGNÉTICO

**52378** 10,00€

0,36 10 40 720



**3Kg**

Ø 6cm



**52378**

**51341** 35,00€

1,62 - 12 96



**9Kg**

Ø 7cm



**51341**

## EXPOSITOR DE FERRAMENTA PNEUMÁTICA

**53147** 41,00€

1,15 5 10 200

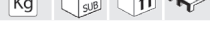

EXPOSITOR SEM FERRAMENTAS





## PISTOLA DE ENCHIMENTO

ANALÓGICA

**53449** 14,00€

0.45	5	20	320
Kg	SUB	ff	ff

0-7 bar  
0-100 PSI



RETROILUMINAÇÃO DE PANTALHA

DIGITAL

**53450** 28,30€

0.40	5	20	320
Kg	SUB	ff	ff

0-16 bar  
0-220 PSI



- Pilhas incluídas.

## PISTOLA LIMPIADORA DE FILTROS DE PARTICULAS

**52543** 182,00€

0.84	-	6	90
Kg	SUB	ff	ff

- Universal.
- Base de alumínio + Corpo inox de longa duração.
- Rango de pressão de trabalho: 3 bar - 7 bar (45 psi - 100PSI).
- Capacidade máxima: 650cc.
- Goma de nylon 4x6 x 2,7 m.



LÍQUIDO DESCARBONIZANTE

**90003** 35,20€

1.08	-	12	400
Kg	SUB	ff	ff



LÍQUIDO NEUTRALIZANTE

**90004** 25,80€

0.50	-	12	320
Kg	SUB	ff	ff



## PISTOLA DE AR + PISTOLA PARA PNEUMÁTICOS

**51981** 21,50€

0.58	5	20	240
Kg	SUB	ff	ff

0-16 bar  
0-220 PSI



## PISTOLA DE AR PARA PNEUMÁTICOS

**51980** 15,00€

0.40	5	25	450
Kg	SUB	ff	ff

0-16 bar  
0-220 PSI



## TESTER PRESSÃO DOS PNEUS

**52648** 9,00€

0.08	5	100	2000
Kg	SUB	ff	ff

5-6 bar



COM TUBO

**53416** 14,10€

0.20	10	100	800
Kg	SUB	ff	ff

0-10 bar



DIGITAL COM TUBO

**53417** 26,30€

0.25	10	100	800
Kg	SUB	ff	ff

0-15 bar  
0-200 PSI

0-1.500 KPA



DIGITAL

**53418** 16,90€

0.20	10	100	800
Kg	SUB	ff	ff

0-15 bar  
0-200 PSI

0-1.500 KPA



## BOMBA DE MASSA NEUMÁTICA

**50751** 43,00€

1.50	5	10	150
Kg	SUB	ff	ff

- Pressão: 30Mpa



500ml

JBM RECOMENDA O USO DE SEUS ÓLEOS LUBRIFICANTES PARA OTIMIZAR O DESEMPENHO E AMPLIAR A VIDA ÚTIL DA FERRAMENTA

EM PAG.144

**14534**  
600ML



**14560**  
100ML



## KIT DE PISTOLAS DE AR

**51277** 64,00€

1.84 - 5 60



- Pistola para pintar de pressão com depósito de 600ml.
- Pistola de ar de pneumáticos com manómetro de pressão.
- Pistola de bufar com depósito para limpeza de peças.
- Mangueira em espiral de 5x8mm com conexão rápida 1/4" extensível até 4,5m.
- Pistola de ar.



## PISTOLA DE AR EM BLISTER

**51383** 11,10€

0.27 10 50 650



- Pistola de ar.
- Conexão rápida europeia.
- Conexão de mangueira.
- Tubo de 10cm.
- Tubo de 20cm.



EM EXPOSITOR DE 10 UDS



## PISTOLA DE AR EXTENSÍVEL

**52798** 18,00€

0.25 10 50 700



285-530mm



PUNTA EMBORRACHADO PARA EVITAR RISCOS

## PISTOLA DE AR

**52490** 6,65€

0.10 10 40 960



100mm



EM EXPOSITOR DE 10 UDS

**52491** 10,50€

0.15 10 80 800



300mm

## PISTOLA DE AR EXTRA-LONGA

**53611** 27,50€

0.50 - 40 160



1.020MM

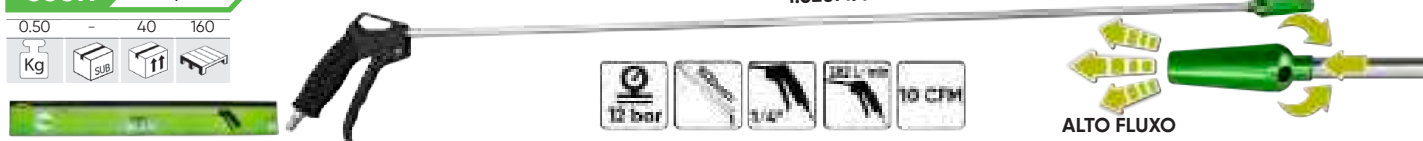

ALTO FLUXO

## PISTOLA DE AR GRAN CAUDAL

**53205** 19,00€

0.90 - 48 500



- Pistola de soprado de grande caudal.
- Material do corpo: Liga de alumínio.
- Superfície: Niquelado.



GRANDE CAUDAL

## PISTOLA DE AR EN BLISTER INDIVIDUAL

**52787** 9,00€

0.20 25 100 1000



## PISTOLA DE AR DE 3/8" COM MANGUEIRA DE 5m

**52381** 20,50€

0.45 5 25 200



- Material: PU // 35 torções.



## FILTRO E REGULADOR DE AR

**53063** 36,70€

0.60 5 50 300



1/4"

**53064** 37,40€

0.63 5 50 300



3/8"

**53065** 36,90€

0.60 5 50 300



1/2"



## FILTRO, REGULADOR DE AR E LUBRIFICADOR

**53066** 61,00€

1.08 5 25 250



1/4"

**53067** 61,00€

0.50 5 25 250



3/8"

**53068** 63,00€

1.00 5 25 250



1/2"



## CONECTOR LUBRIFICANTE

**14561** 8,80€

0.05 25 50 -



1/4"



## ÓLEO PARA FERRAMENTA PNEUMÁTICA

**14534** 16,50€

0.55 - 12 540



600ml

**14560** 8,80€

0.10 12 72 1008



100ml





## PISTOLA DE SECAGEM PNEUMÁTICA

54248 58,00€

0,63 5 20 240  
Kg sub ff

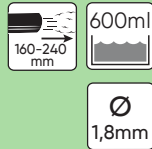

## PISTOLA DE PINTURA PROFSSIONAL

54249 103,00€

0,71 5 20 240  
Kg sub ff

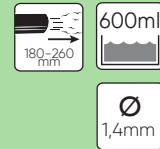

## PISTOLA DE SECAGEM DE AR PNEUMÁTICA

53606 55,00€

0,60 5 20 -  
Kg sub ff



CE



VÁLVULA REGULADORA DE AR

## PISTOLA DE JACTO DE AREIA PNEUMÁTICA

53593 41,00€

2,75 - 5 80  
Kg sub ff

- Contém:  
1x pistola jateadora.  
1x Recolhedor de Areia.  
2x 850g recipientes de areia.  
Casquilhos 4x:  
para jateamento.  
para jateamento de superfície.  
para jateamento de canto exterior.  
para jateamento de canto interior.



- Tamanho de grão: 46-100MeSH 0.354-0.149mm

- Ideal para a carroçaria e todos os tipos de superfícies metálicas: permite remover a oxidação, a sujidade excessiva e / ou o revestimento, verniz etc. facilmente.



FRASCO DE AREIA PARA REF. 53593

14168 7,00€

0,95 - 20 -  
Kg sub ff



## SUPORE DE SOPRO DE AR COM 2 PISTOLAS DE SECAGEM

53607 292,00€

7,35 - 2 36  
Kg sub ff

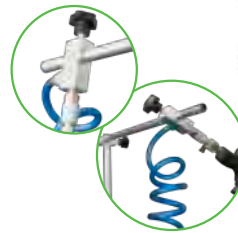

**360°** Permite um movimento de 360° da pistola, além de bloqueá-la em qualquer posição.



Altura ajustável até 208cm e largura até 86cm.

- Sustenta com segurança 2 pistolas de secagem  
- Contém 2 manguieiras de ar em espiral: 8mm x 12mm x 5m  
- Corpo de aço com acopladores de ar de latão  
- Contém duas pistolas pneumáticas de secagem (ref. 53606) com as seguintes características:  
Corpo em alumínio.  
Pressão de trabalho: 2-4 bar (30-60psi).  
Consumo de ar: 325 l / min.  
Entrada de ar: 1/4".  
Com válvula reguladora de ar.

## PISTOLA DE PETROLEADO

53202 15,70€

1,40 - 10 80  
Kg sub ff



- Pistola de limpeza do motor.  
- Material do pote: Aço.  
- Material do corpo: liga de alumínio.  
- Superfície: Pintura em pó.



## PISTOLA DE LIMPEZA TORNADO

53204 81,00€

0,90 - 5 60  
Kg sub ff

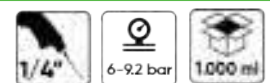

- Pistola de limpeza de carros, tornado.  
- Material do pote: PE.  
- Material do corpo: Liga de alumínio.  
- Superfície do corpo: Pulido.



## CARRETEL DE MANGUEIRA DE AR BOCA DE 3/8" 20+2m

**53582** 179,00€

**53583** 170,00€

10.85	-	1	14
Kg	Sub	ft	ft

10.75	-	1	14
Kg	Sub	ft	ft



**14772** 8,50€

0.35	-	20	-
Kg	Sub	ft	ft

## CARRETEL DE MANGUEIRA DE AR BOCA DE 3/8" 12+1m

**53532** 119,00€

**53581** 115,00€

6.80	-	2	30
Kg	Sub	ft	ft

6.70	-	2	30
Kg	Sub	ft	ft



**14771** 10,50€

0.35	-	30	-
Kg	Sub	ft	ft

## CARRETEL DE MANGUEIRA DE AR BOCA DE 11m

**53881** 79,00€

**53882** 79,00€

4.50	-	4	48
Kg	Sub	ft	ft

4.50	-	4	48
Kg	Sub	ft	ft

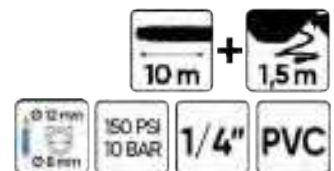

SUPORTE DE PAREDE INCLUIDO



COM REPARTIDOR



## MANGUEIRA ESPIRAL PNEUMÁTICA

<b>53629</b>	14,30€	10m	<b>53630</b>	18,80€	15m
0.55 - 6 372	8mm		0.65 - 6 240	8mm	
<b>53632</b>	46,00€	15m	<b>53631</b>	33,50€	15m
2.20 - 6 78	15mm		1.25 - 6 132	12mm	
<b>53634</b>	63,00€	15m	<b>53633</b>	46,00€	15m
2.60 - 6 66	18mm		2.10 - 6 78	15mm	

COM EXTREMIDADES GIRATÓRIAS DE 360 GRAUS PARA FACILITAR O MOVIMENTO E A FACILIDADE DE USO

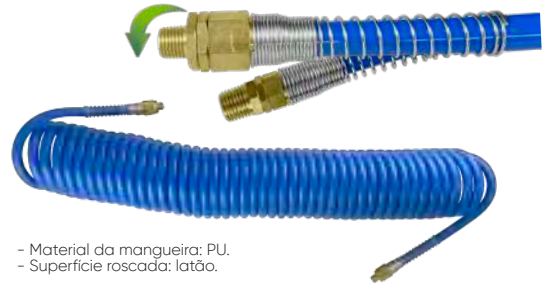

- Material da mangueira: PU.  
- Superfície rosçada: latão.

## MANGUEIRA DE AR

<b>53594</b>	54,00€	3.10 - 4 96	<b>53595</b>	61,00€	3.20 - 4 96



- Pressão de trabalho: 300PSI / 20bar.  
- Pressão de ruptura: 950PSI / 65bar.  
- Temperatura de trabalho: -40°C / 65°C

- Grande flexibilidade.  
- Retorna à sua forma original.  
- Superfície lisa, não danifica a pintura.  
- Muito resistente.

<b>53594</b>	<b>53595</b>
Diâmetro interior: 8mm Diâmetro exterior: 13mm Para usar com: Ref. 52736 M8	Diâmetro interior: 10mm Diâmetro exterior: 15mm Para usar com: Ref. 52737 M10

**25m** 300 PSI 20 BAR  
HYBRID POLYMER

x10

**JOGO DE 10 BRAÇADEIRAS 8-16mm**

<b>14169</b>	3,00€
0.10 - 125 -	

## CONECTOR UNIVERSAL DE SEGURANÇA PARA MANGUEIRA

<b>14201</b>	4,00€	0.10 25 100 -	<b>M6</b>
<b>14202</b>	4,00€	0.10 25 100 -	<b>M8</b>
<b>14203</b>	4,50€	0.10 25 100 -	<b>M10</b>

## CONECTOR ARTICULADO MACHO PARA AR COMPRIMIDO EURO

<b>14314</b>	5,00€	0.06 25 100 -	<b>14315</b>	4,50€	0.06 25 100 -

## CONECTOR DE MANGUEIRA

REF.	DESCRIÇÃO				€
14204	EUR - M6	0,06	25	100	1,50€
14205	EUR - M8	0,06	25	100	1,50€
14206	EUR - M10	0,06	25	100	1,50€
14207	US - M6	0,06	25	100	1,50€
14208	US - M8	0,06	25	100	1,50€
14209	US - M10	0,06	25	100	1,50€

<b>14204</b>	<b>14205</b>	<b>14206</b>	<b>14209</b>

## CONECTOR DE SEGURANÇA UNIVERSAL

REF.	DESCRIÇÃO				€
14195	ROSCA INTERNA - ROSCA EXTERNA 1/4"	0,5	25	100	4,00€
14196	ROSCA INTERNA - ROSCA EXTERNA 3/8"	0,10	25	100	4,00€
14197	ROSCA INTERNA - ROSCA EXTERNA 1/2"	0,10	25	100	4,50€
14198	ROSCA INTERNA - ROSCA INTERNA 1/4"	0,10	25	100	4,00€
14199	ROSCA INTERNA - ROSCA INTERNA 3/8"	0,10	25	100	4,00€
14200	ROSCA INTERNA - ROSCA INTERNA 1/2"	0,10	25	100	4,50€

<b>14195</b>	<b>14196</b>	<b>14197</b>	<b>14198</b>	<b>14199</b>	<b>14200</b>

# CONECTOR / ROSCA

REF.	DESCRIÇÃO	Kg	€
<b>US</b>			
13930	CONECTOR MACHO - ROSCA MACHO DE 1/4"	0,05	1,50€
13932	CONECTOR MACHO - ROSCA MACHO 3/8"	0,1	2,50€
14076	CONECTOR MACHO - ROSCA FÊMEA DE 3/8"	0,1	1,50€
13933	CONECTOR MACHO - ROSCA MACHO DE 1/2"	0,1	2,00€
13935	CONECTOR MACHO - ROSCA FÊMEA DE 1/4"	0,05	2,50€
13936	CONECTOR FÊMEA - ROSCA FÊMEA DE 1/4"	0,05	3,50€
13937	CONECTOR FÊMEA - ROSCA MACHO DE 1/4"	0,05	4,00€
14078	CONECTOR FÊMEA - ROSCA FÊMEA DE 3/8"	0,1	4,00€
14191	CONECTOR MACHO - ROSCA FÊMEA DE 1/2"	0,1	2,00€
14193	CONECTOR FÊMEA - ROSCA FÊMEA DE 1/2"	0,1	4,00€
<b>EUR.</b>			
13931	CONECTOR MACHO - ROSCA MACHO DE 1/4"	0,05	2,50€
14075	CONECTOR MACHO - ROSCA FÊMEA DE 3/8"	0,1	2,00€
13934	CONECTOR MACHO - ROSCA FÊMEA DE 1/4"	0,05	2,50€
13938	CONECTOR FÊMEA - ROSCA FÊMEA DE 1/4"	0,1	3,50€
13939	CONECTOR FÊMEA - ROSCA MACHO DE 1/4"	0,1	4,00€
14077	CONECTOR FÊMEA - ROSCA FÊMEA DE 3/8"	0,1	4,50€
14190	CONECTOR MACHO - ROSCA FÊMEA DE 1/2"	0,1	2,00€
14192	CONECTOR FÊMEA - ROSCA FÊMEA DE 1/2"	0,1	4,00€

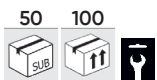

## ENGATE RÁPIDO PNEUMÁTICO

52735	4,85€	M6	52736	5,35€	M8	52737	5,50€	M10			
0.05	25	200	4000	0.10	25	200	4000	0.10	25	200	4000
Kg	BOX	BOX	BOX	Kg	BOX	BOX	BOX	Kg	BOX	BOX	BOX



- Contém uma tomada externa e interna.

## ADAPTADOR ARTICULADO PNEUMÁTICO

12988	12,00€	1/2"	13809	18,50€	1/4"	13810	20,50€	3/8"			
0.15	62	125	-	0.10	62	250	-	0.10	62	250	-
Kg	BOX	BOX	BOX	Kg	BOX	BOX	BOX	Kg	BOX	BOX	BOX







## **FERRAMENTAS DE IMPACTO**

- 150 CONJUNTOS DE CHAVES DE CAIXA DE IMPACTO
- 152 BARRAS DE EXTENSÃO  
/ ARTICULADORES DE IMPACTO
- 153 CONJUNTOS DE PONTAS
- 154 ADAPTADORES DE IMPACTO  
/ CHAVES DE CAIXA DE IMPACTO DE 3/4" E 1"
- 156 FERRAMENTAS DE IMPACTO VEÍCULOS PESADOS

## KIT DE 6 CHAVES DE IMPACTO DE 1/2" HEX

52337 65,00€

1,91 5 10 300



CONTÉM

	x3	30, 32, 36mm
	x3	14, 17, 19mm

## SET DE 8 CHAVES E PUNTAS XZN DE IMPACTO DE 1/2"

52547 96,00€

2,70 - 5 200



CONTÉM

	x4	27, 30, 32, 34, 36mm
	x3	M14, M16, M18

## KIT DE 13 CHAVES DE IMPACTO DE 1/2" HEX + ADAPTADOR

52341 58,00€

1,70 - 4 336



10, 11, 12, 13, 14, 17, 19, 21, 22, 24mm

REPOSIÇÕES DISPONÍVEI

REF.	mm	Kg	SUB	ff	mm	€
14728	10mm	0,10	5	20	3,80€	
14729	11mm	0,05	5	20	3,80€	
14730	12mm	0,05	5	20	3,80€	
14731	13mm	0,10	5	20	3,80€	
14732	14mm	0,10	5	20	3,80€	
11195	17mm	0,10	10	50	3,70€	
11121	19mm	0,10	10	60	4,10€	
14733	21mm	0,10	5	20	4,30€	
14734	22mm	0,15	5	20	5,40€	
11122	24mm	0,15	10	20	5,45€	
REF.	mm	Kg	SUB	ff	mm	€
14735	Suporte de juntas de imp.	0,05	5	20	6,50€	
12074	Aumento de imp. 250mm	0,23	10	60	11,50€	
11990	Artic. universal de impacto	0,15	100	100	15,30€	

## SET DE 3 CHAVES XZN DE 1/2" DE IMPACTO

52694 49,00€

1,31 5 10 600



30, 32, 36mm (78mmL)

## KIT 19 CHAVES DE IMPACTO DE 1/2" + ADAPTADOR

52345 109,00€

3,55 - 6 240



53531 109,00€

3,55 - 4 240



52345: REPOSIÇÕES DISPONÍVEI

REF.	mm	Kg	SUB	ff	mm	€
14728	10mm	0,10	5	20	3,80€	
14729	11mm	0,05	5	20	3,80€	
14730	12mm	0,05	5	20	3,80€	
14731	13mm	0,10	5	20	3,80€	
14732	14mm	0,10	5	20	3,80€	
14970	15mm	0,08	5	20	2,50€	
14971	16mm	0,07	5	20	2,50€	
11195	17mm	0,10	10	50	3,70€	
14972	18mm	0,12	5	20	3,50€	
11121	19mm	0,10	10	60	4,10€	
14733	21mm	0,10	5	20	4,30€	
14734	22mm	0,15	5	20	5,40€	
11122	24mm	0,15	10	20	5,45€	
11123	27mm	0,35	10	50	6,50€	
12937	Aumento de impacto 50mm	0,11	10	100	9,50€	
14973	Aumento de impacto 150mm	-	5	20	11,50€	
12075	Aumento de impacto 250mm	0,45	10	50	15,50€	
11962	Adaptador de impacto 1/2"H 3/4"M	0,15	10	100	7,50€	
11990	Artic. universal de impacto	0,15	10	100	15,30€	

## KIT 12 CHAVES DE IMPACTO COMPRIDOS DE 1/2"

52346 103,00€

4,55 - 6 252



REPOSIÇÕES DISPONÍVEI

REF.	mm	Kg	SUB	ff	mm	€
12071	24mm	0,30	10	50	11,00€	
12072	27mm	0,35	10	20	12,00€	
12074	Aumento de impacto 125mm	0,23	10	60	11,50€	
12075	Aumento de impacto 250mm	0,45	10	50	15,50€	
11990	Artic. universal de impacto	0,15	10	100	15,30€	
REF.	mm	Kg	SUB	ff	mm	€
12061	10mm	0,14	10	100	9,50€	
12062	12mm	0,15	10	100	9,50€	
12063	13mm	0,15	10	50	9,50€	
12064	15mm	0,17	10	100	9,00€	
12065	16mm	0,30	10	20	9,00€	
12066	17mm	0,20	10	50	9,00€	
12067	18mm	0,20	10	20	9,50€	
12068	19mm	0,21	10	50	9,50€	
12069	21mm	0,25	10	50	9,50€	
12070	22mm	0,30	10	20	10,50€	





## JOGO DE 12 CHAVES DE IMPACTO 1/2" HEX.PERFIL BAIXO

**53060** 34,90€

10, 11, 12, 13, 14, 15, 16, 17, 18,  
19, 20, 21mm (28,2mmL)



1/2"

12  
PCS

0,85 5 25 500



28mmL



## KIT DE 11 CHAVES DE IMPACTO DE 1/2"

**53744** 63,00€

**52342** 63,00€

10, 11, 12, 13, 14, 16, 17, 19,  
21, 22, 24mm (78mmL)

1/2"

11  
PCS

2,30 5 10 360



2,05 5 10 360



### REPOSIÇÕES DISPONÍVEI

REF.	mm	Kg	SUB	ff	€
12061	10mm	0,14	10	100	9,50€
14736	11mm	0,15	5	20	5,00€
12062	12mm	0,15	10	100	9,50€
12063	13mm	0,15	10	50	9,50€
14737	14mm	0,15	5	20	5,00€
12065	16mm	0,30	10	20	9,00€
12066	17mm	0,20	10	50	9,00€
12068	19mm	0,21	10	50	9,50€
12069	21mm	0,25	10	50	9,50€

REF.	mm	Kg	SUB	ff	€
12070	22mm	0,30	10	20	10,50€
12071	24mm	0,30	10	50	11,00€

## KIT DE 3 CHAVES DE IMPACTO HEX. LONGO

**52969** 20,70€



1/2"

3  
PCS

0,80 5 20 640



17, 19, 21mm  
(78mmL)



## CONJUNTO DE 4 CHAVES DE CAIXA DE IMPACTO PARA RODAS DE LIGA LEVE - 1/2"

**53587** 44,00€

1/2"

4  
PCS

1,05 5 20 -



### REPOSIÇÕES DISPONÍVEI

REF.	mm	Kg	SUB	ff	€
14172	15mm - SMART	0,20	10	50	8,50€
14173	17mm - MERCEDES	0,20	10	50	9,50€
14177	22mm - OPEL	0,25	10	50	9,50€
14178	21mm - HYUNDAI/KIA	0,25	10	50	9,50€



## KIT 4 CHAVES IMPACTO DE 1/2" PARA RODAS

**52338** 41,00€



1/2"

4  
PCS

1,00 5 20 640



17, 19, 21, 22mm (85mmL)



### REPOSIÇÕES DISPONÍVEI

REF.	mm	Kg	SUB	ff	€
11314	17mm	0,21	10	100	8,50€
11315	19mm	0,23	10	100	8,50€
11316	21mm	0,26	10	100	8,50€
11628	22mm	0,27	10	50	9,50€

## KIT DE 3 CHAVES DE IMPACTO DE 1/2"

**51336** 29,30€

17, 19, 21mm  
(85mmL)



1/2"

3  
PCS

0,85 - 5 700



## KIT DE 10 CHAVES DE IMPACTO DE 1/2"

53988 101,00€

3.00	-	10	120
Kg	Sub	ff	ff

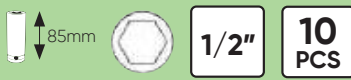

10 PCS

### CONTÉM

X7 1/2"	15, 17, 19, 21, 22, 23, 24mm
X1 7/8"	Tesla
X1 17mm	Mercedes
X1 21mm	Hyundai/Kia



## KIT DE 12 CHAVES DE IMPACTO DE 1/2" HEX.

52343 52,00€

1.90	-	4	360
Kg	Sub	ff	ff



12 PCS

### CONTÉM

X3 85mmL	17, 19, 21mm
X1 42mmL	27mm
X8 38mmL	10, 11, 13, 14, 17, 19, 22, 24mm



## CONJUNTO DE 4 CHAVES DE IMPACTO PARA PARAFUSOS DE SEGURIDADE

53197 46,00€

1.17	5	20	-
Kg	Sub	ff	ff



1/2" 4 PCS

17, 19, 21, 22mm (82mmL)

## CONJUNTO DE BARRAS DE EXTENSÃO DE IMPACTO

53077 62,00€

1.58	-	10	240
Kg	Sub	ff	ff



CrMo 1/2" 5 PCS



100, 110, 120, 135, 150 Nm

### BARRAS DE EXTENSÃO DE IMPACTO

<p>200NM</p> <p>13680 15,50€</p> <p>0.36 - 50 - -</p> <p>Kg Sub ff ff</p>	<p>175NM</p> <p>13682 15,50€</p> <p>0.32 - 50 - -</p> <p>Kg Sub ff ff</p>	<p>150NM</p> <p>13684 15,50€</p> <p>0.28 - 50 - -</p> <p>Kg Sub ff ff</p>	<p>120NM</p> <p>13686 15,50€</p> <p>0.23 - 5 - 50 - 1000</p> <p>Kg Sub ff ff</p>	<p>100NM</p> <p>13688 15,50€</p> <p>0.22 - 50 - 1500</p> <p>Kg Sub ff ff</p>	<p>190NM</p> <p>13681 15,50€</p> <p>0.35 - 50 - -</p> <p>Kg Sub ff ff</p>	<p>160NM</p> <p>13683 15,50€</p> <p>0.30 - 50 - -</p> <p>Kg Sub ff ff</p>	<p>135NM</p> <p>13685 15,50€</p> <p>0.25 - 5 - 50 - 1500</p> <p>Kg Sub ff ff</p>	<p>110NM</p> <p>13687 15,50€</p> <p>0.22 - 5 - 50 - -</p> <p>Kg Sub ff ff</p>	<p>90NM</p> <p>13689 15,30€</p> <p>0.20 - 5 - 50 - 1500</p> <p>Kg Sub ff ff</p>
---	---	---	--	--	---	---	--	---	---

## EXTENSORES DE IMPACTO

12937 9,50€

0.11	10	100	1500
Kg	Sub	ff	ff

50mm



12074 11,50€

0.23	10	60	-
Kg	Sub	ff	ff

125mm



12075 15,50€

0.45	10	50	-
Kg	Sub	ff	ff

250mm

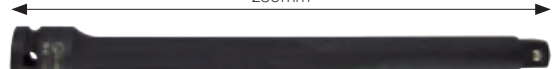

1/2"

## ARTICULAÇÃO UNIVERSAL DE IMPACTO 3/4" - 1/2"

11938 47,00€

0.62	6	30	-
Kg	Sub	ff	ff

3/4"



## KIT DE 3 ARTICULAÇÕES DE IMPACTO COM DUPLA POSIÇÃO (FIXO/ARTICULADO)

53043 53,00€

0.43	5	50	1000
Kg	Sub	ff	ff

1/2" 3/8" 1/4" 3 PCS



11990 15,30€

0.15	10	100	100
Kg	Sub	ff	ff

1/2"

11938 11990



## KIT DE 8 CHAVES DE IMPACTO HEX. COM DUPLA POSIÇÃO (FIXO/ARTICULADO)

**53044** 121,00€

2,43 - 8 1000



1/2"

8  
PCS

13, 14, 15, 16, 17,  
19, 21, 22mm

## SET DE 6 CHAVES E PUNTAS XZN DE IMPACTO DE 1/2"

**52546** 39,60€

0,80 5 10 720



1/2"

6  
PCS

REF.	mm	Kg	Sub	Qt	€
12931	43mmL	0,08			7,50€
12932	43mmL	0,08			7,50€
12933	43mmL	0,08			8,00€
12934	78mmL	0,08			7,50€
12935	78mmL	0,08			8,00€
12936	78mmL	0,08			8,50€



## CHAVE PONTA XZN INVIOVEL

**52810** 9,00€

0,20 5 100 -



M16



1/2"

75mm



- Soquetes de impacto de 75mm de comprimento quadrados de 1/2" para extrair o parafuso de drenagem com chave de impacto em transmissões de VAG, Porsche, Ford, etc.

**52811** 9,90€

0,15 5 100 -



M18

- Para extrair o braço de direção do veículos do grupo VAG.



## KIT 13 CHAVES DE IMPACTO DE 1/2" HEX E TORX

**52344** 197,00€

1,45 - 10 600



1/2"

13  
PCS

### CONTÉM

- x5 45mmL 5, 6, 8, 10, 12mm
- x8 45mmL T30, T40, T45, T50, T55, T60, T70, T80

## KIT DE 8 CHAVES DE IMPACTO HEX DE 1/2"

**52339** 61,00€

1,25 5 10 360



### REPOSIÇÕES DISPONÍVEI

REF.	mm	Kg	Sub	Qt	€
14004	5mm	0,1	10	240	9,50€
14005	6mm	0,1	10	120	10,50€
14006	7mm	0,1	10	240	9,50€
14007	8mm	0,2	10	240	9,50€
14008	10mm	0,1	10	240	9,50€
14009	12mm	0,1	10	240	9,50€
14010	14mm	0,1	10	120	11,00€
14011	17mm	0,2	10	60	11,00€



1/2"

8  
PCS

5, 6, 7, 8, 10, 12, 14,  
17mm (78mmL)

## KIT DE 8 CHAVES DE IMPACTO TORX DE 1/2"

**52340** 58,00€

1,15 5 10 360



### REPOSIÇÕES DISPONÍVEI

REF.	mm	Kg	Sub	Qt	€
12938	T25	0,08	10	50	10,00€
12939	T30	0,09	10	50	10,00€
12940	T40	0,09	10	50	10,00€
12941	T45	0,09	10	50	10,00€
12942	T50	0,09	10	60	10,00€
12943	T55	0,1	10	50	10,00€
12944	T60	0,12	10	50	10,00€
12945	T70	0,14	10	20	10,50€



1/2"

8  
PCS

T25, T30, T40, T45, T50,  
T55, T60, T70 (78mmL)

## CONJUNTO DE 6 CABEÇAS DE CHOQUE

53743 39,70€

0,80	5	20	960
Kg	SUB	11	11

6  
PCS

M	F
3/4"	1/2"
1/2"	3/4"
3/8"	1/4"
1/4"	3/8"
3/8"	1/2"



### REPOSIÇÕES DISPONÍVEL

REF.	mm	Kg	SUB	11	€
14749	1/4" F - 3/8" M	-	20	100	2,00€
14750	3/8" M - 1/4" F	-	20	100	2,00€
14751	3/8" M - 1/2" F	-	20	100	4,00€
14752	1/2" F - 3/8" M	-	10	100	4,00€

## JOGO DE 2 ADAPTADORES DE IMPACTO 1"-1/2"

52545 177,00€

3,00	1	4	1500
Kg	SUB	11	11

1" 1/2" F - 1" M  
1" F - 1" 1/2" M



## JOGO DE 8 CHAVES DE IMPACTO LARGAS HEX. DE 3/4"

53470 176,00€

7,50	-	1	85
Kg	SUB	11	11

3/4" 8  
PCS

24, 27, 29, 30, 32, 34, 36, 38mm (90mmL)



## SET DE 6 ADAPTADORES DE IMPACTO

52544 93,00€

2,90	-	4	384
Kg	SUB	11	11

6  
PCS 1" 3/4" 1/2"

### CONTÉM

1/2"	x2	H x 1" M (50mmL), H x 3/4" M (48mmL)
3/4"	x2	H x 1" M (63mmL), H x 1/2" M (85mmL)
1"	x2	H x 3/4" M (69mmL), H x 1/2" M (70mmL)



### REPOSIÇÕES DISPONÍVEL

REF.	mm	Kg	SUB	11	€
11962	1/2" H - 3/4" M	0,16	10	100	7,50€
11963	1/2" H - 1" M	0,26	6	54	9,00€
11964	3/4" H - 1/2" M	0,34	6	36	12,50€
11965	3/4" H - 1" M	0,44	6	48	16,00€
11966	1" H - 1/2" M	0,53	6	36	18,00€
11967	1" H - 3/4" M	0,53	4	36	18,00€



## KIT DE 8 CHAVES DE IMPACTO DE 3/4"

52347 158,00€

6,25	-	4	200
Kg	SUB	11	11

3/4" 8  
PCS

26, 27, 29, 30, 32, 35, 36, 38mm (90mmL)



## SET DE 16 CHAVES DE IMPACTO

51028 163,00€

6,25	-	2	-
Kg	SUB	11	11

3/4" 16  
PCS

### CONTÉM

3/4"	x4	E18, E20, E22, E24
3/4"	x5	T60, T70, T80, T90, T100
3/4"	x4	H17, H19, H22, H24
x2	1" - 3/4"	
x1	4mm	



### REPOSIÇÕES DISPONÍVEL

REF.	mm	Kg	SUB	11	€
14723	H17	0,35	-	10	18,00€
14724	T60	0,30	-	10	18,50€
14725	T70	0,30	-	10	18,50€
14726	T80	0,30	-	10	17,50€



## KIT DE 8 CHAVES DE IMPACTO DE 1"

52348 179,00€

5,85	-	2	252
Kg	SUB	11	11

1" 8  
PCS

24, 27, 30, 32, 33, 36, 38, 41mm



### REPOSIÇÕES DISPONÍVEL

REF.	mm	Kg	SUB	11	€
13859	24mm	0,6	6	96	16,00€
13874	27mm	0,6	6	72	17,50€
13875	30mm	0,5	6	18	18,50€
13876	32mm	0,6	6	24	18,50€
13877	33mm	0,6	6	96	18,50€
11153	36mm	0,7	6	18	23,40€
11155	38mm	0,9	6	12	24,40€
11158	41mm	0,95	6	18	28,50€





# CHAVES DE CAIXA DE IMPACTO



1"						
REF.	mm	Kg	Sub	11	€	
11153	36mm	0,71	6	18	23,40€	
11154	37mm	0,73	6	24	21,70€	
11155	38mm	0,74	6	12	24,40€	
11156	39mm	0,74	6	24	28,90€	
11157	40mm	0,78	6	12	26,60€	
11158	41mm	0,81	6	18	28,50€	
11159	42mm	0,91	6	18	30,30€	
11160	43mm	0,94	6	12	27,00€	
11161	44mm	0,93	6	18	32,30€	
11162	45mm	0,94	4	8	29,10€	
11163	46mm	1,00	4	12	32,70€	
11164	47mm	1,02	4	8	30,70€	
11165	48mm	1,01	4	8	34,60€	
11166	50mm	1,18	4	12	30,90€	
11167	51mm	1,18	4	8	38,00€	
11168	52mm	1,18	1	10	41,00€	
11169	53mm	1,27	4	12	39,20€	
11170	54mm	1,33	4	12	40,00€	
11171	55mm	1,44	2	8	51,00€	
11172	56mm	1,47	4	8	48,00€	
11173	57mm	1,44	4	8	47,00€	
11174	58mm	1,58	4	8	47,00€	
11175	59mm	1,58	4	8	49,00€	
11176	60mm	1,62	2	4	56,00€	
11177	62mm	1,63	2	4	55,00€	
11178	63mm	1,75	-	8	53,00€	
11179	65mm	1,87	2	8	65,00€	
11180	67mm	1,93	2	8	59,00€	
11181	68mm	1,93	2	8	65,00€	
11182	70mm	2,09	2	4	73,00€	
11183	71mm	3,10	-	6	70,00€	
11184	73mm	3,27	-	4	87,00€	
11185	75mm	3,34	1	6	97,00€	
11186	76mm	3,70	-	5	91,00€	
11187	78mm	3,47	-	5	98,00€	
11188	80mm	3,69	1	4	103,00€	
11189	85mm	3,81	1	4	121,00€	
11190	89mm	3,80	-	2	138,00€	
11191	90mm	4,29	1	4	149,00€	
11192	92mm	4,50	1	2	152,00€	
11193	95mm	4,89	-	2	183,00€	
11194	100mm	4,36	1	4	176,00€	
11621	105mm	7,81	1	2	359,00€	
11622	110mm	7,75	1	2	399,00€	
11623	115mm	8,21	1	2	489,00€	

1/2"						
REF.	mm	Kg	Sub	11	€	
14728	10mm	0,10	5	20	3,80€	
14729	11mm	0,05	5	20	3,80€	
14730	12mm	0,05	5	20	3,80€	
14731	13mm	0,10	5	20	3,80€	
14732	14mm	0,10	5	20	3,80€	
11195	17mm	0,10	10	50	3,70€	
11121	19mm	0,10	10	60	4,10€	
14733	21mm	0,10	5	20	4,30€	
14734	22mm	0,15	5	20	5,40€	
11122	24mm	0,14	10	20	5,45€	
11123	27mm	0,17	10	50	6,50€	
11124	30mm	0,20	10	50	7,65€	
11125	32mm	0,22	10	50	8,50€	

3/4"						
REF.	mm	Kg	Sub	11	€	
11126	19mm	0,25	6	60	11,20€	
11127	21mm	0,29	6	24	13,80€	
11128	22mm	0,34	6	24	14,10€	
11129	24mm	0,32	6	54	14,10€	
11130	25mm	0,33	6	24	13,10€	
11131	26mm	0,32	6	36	14,10€	
11132	27mm	0,35	6	54	13,70€	
11133	28mm	0,40	6	12	12,00€	
11134	30mm	0,41	6	24	15,00€	
11135	32mm	0,44	6	48	17,20€	
11136	33mm	0,47	6	12	15,30€	
11137	34mm	0,51	6	24	18,20€	
11138	35mm	0,49	6	12	18,00€	
11139	36mm	0,52	6	24	18,80€	
11140	38mm	0,53	6	24	20,40€	
11141	40mm	0,54	6	12	18,60€	
11142	41mm	0,61	6	12	21,30€	
11143	46mm	0,74	6	18	26,40€	
11144	50mm	1,00	6	24	33,30€	
11145	51mm	1,10	4	12	35,30€	
11146	55mm	1,23	4	12	37,30€	
11147	57mm	1,23	4	12	41,00€	
11148	60mm	1,40	4	12	47,00€	
11149	63mm	1,32	4	12	45,00€	
11150	65mm	1,50	1	8	55,00€	
11151	67mm	1,49	4	12	57,00€	
11152	70mm	1,49	4	12	57,00€	

1"						
REF.	mm	Kg	Sub	11	€	
11624	65mm	2,42	1	2	189,00€	
11625	85mm	5,11	1	2	282,00€	
12984	105mm	4,8	1	2	379,00€	

1/2" 78mmL						
REF.	mm	Kg	Sub	11	€	
14738	10mm	-	10	100	5,50€	
14739	11mm	-	10	100	5,50€	
14740	12mm	-	10	100	5,55€	
14741	13mm	-	10	100	5,55€	
14742	14mm	-	10	100	5,55€	
14743	16mm	-	10	100	5,15€	
14744	17mm	-	10	50	5,35€	
14745	19mm	-	10	50	6,25€	
14746	21mm	-	10	50	6,40€	
14747	22mm	-	10	50	7,10€	
14748	24mm	-	10	50	8,30€	
11613	27mm	0,34	10	20	11,00€	
11614	30mm	0,42	10	40	13,00€	
11615	32mm	0,38	6	24	14,20€	
11616	33mm	0,45	6	12	18,10€	
11617	34mm	0,40	6	24	18,70€	
11618	35mm	0,46	6	18	18,80€	
11619	36mm	0,47	6	36	19,50€	

1/2" 78mmL						
REF.	mm	Kg	Sub	11	€	
12061	10mm	0,14	10	100	9,50€	
14736	11mm	0,15	5	20	5,00€	
12062	12mm	0,15	10	100	9,50€	
12063	13mm	0,13	10	50	9,50€	
14737	14mm	0,15	5	20	5,00€	
12064	15mm	0,17	10	100	9,00€	
12065	16mm	0,16	10	20	9,00€	
12066	17mm	0,18	10	50	9,00€	
12067	18mm	0,23	10	20	9,50€	
12068	19mm	0,21	10	50	9,50€	
12069	21mm	0,24	10	50	9,50€	
12070	22mm	0,28	10	20	10,50€	
12071	24mm	0,30	10	50	11,00€	
12072	27mm	0,35	10	20	12,00€	

3/4" 90mmL						
REF.	mm	Kg	Sub	11	€	
13723	19mm	0,41	6	12	18,50€	
13724	21mm	0,48	6	12	19,20€	
13725	22mm	0,61	6	18	19,20€	
13726	24mm	0,56	6	24	19,00€	
13727	26mm	0,51	6	18	18,70€	
13728	27mm	0,50	6	18	18,50€	
13729	29mm	0,71	6	12	22,00€	
13730	30mm	0,68	6	24	22,00€	
13731	32mm	0,71	6	24	21,60€	
13732	33mm	0,78	5	15	23,80€	
13733	34mm	0,81	6	18	24,90€	
13734	35mm	0,80	6	18	25,70€	
13735	36mm	0,81	6	12	25,80€	
13736	38mm	0,83	6	18	25,90€	

1" 90mmL						
REF.	mm	Kg	Sub	11	€	
13745	28mm	0,77	6	24	25,20€	
13746	30mm	0,95	6	12	25,40€	
13747	32mm	0,90	6	12	25,40€	
13748	33mm	0,89	6	12	24,90€	



# CHAVES PARA VEÍCULOS PESADOS

## CHAVE DE EXTRAÇÃO DE CASTILHO BPW

**52914** 223,00€

2.90 - 4 500



- Extração casquilho eixo traseiro BPW.



120mm 8 CANTOS  
CUADRADO HEXAGONAL 41mm

## CHAVE DE EXTRAÇÃO DE CASTILHO BPW

**52915** 199,00€

2.90 - 8 1500



- Extração casquilho eixo traseiro BPW.



111mm OVAL  
CUADRADO HEXAGONAL 41mm

## CHAVE DE EXTRAÇÃO DE CASTILHO BPW

**52916** 218,00€

2.57 - 6 1000



- Extração casquilho eixo traseiro BPW.



109mm 8 CANTOS  
CUADRADO HEXAGONAL 41mm

## CHAVE DE EXTRAÇÃO DE CASTILHO BPW

**52917** 122,00€

1.05 - 10 1000



- Extração casquilhos tractores 6,5-9 TON.



65mm OVAL  
CUADRADO HEXAGONAL 36mm

## CHAVE HUBCAPS EIXO TRASEIRO BPW

**52918** 146,00€

2.05 - 8 1500



- Extração eixo traseiro.



95mm  
CUADRADO 3/4"

## CHAVE NUT RODA BPW

**52919** 181,00€

2.65 - 8 1500



- Extração eixo traseiro.



110mm 8 CANTOS  
CUADRADO 3/4"

## CHAVE EXTRAÇÃO ROLAMENTIOS EIXO BPW

**52920** 155,00€

1.35 - 10 1000



- Para remover os rolamentos acima nut em eixos BPW 12 TON.



80mm  
CUADRADO 3/4"

## CHAVE EXTRAÇÃO NUT EIXO TRASEIRO BPW

**52921** 117,00€

0.73 - 10 500



- Para remover os rolamentos acima nut em eixos BPW 6,5-9 TON.



65mm  
CUADRADO 3/4"

## CHAVE EXTRAÇÃO PORCA ROLAMENTOS EIXOS BPW

**52922** 180,00€

2.10 - 10 1000



- En eixos BPW 16 TON.



85mm 6 CANTOS  
CUADRADO 3/4"

## CHAVE EXTRAÇÃO NUT SUSPENSÃO SCANIA

**52923** 59,00€

0.55 - 12 1500



28x37mm  
CUADRADO 3/4"





## CHAVE EXTRAÇÃO EIXO SUSPENSÃO SCANIA

**52924** 52,00€

0,75 - 24 1500



34x46mm

CUADRADO 3/4"



## CHAVE RODA DIANTEIRA SCANIA

**52925** 176,00€

1,80 - 10 1500



80mm

8 CANTOS

CUADRADO HEXAGONAL 41mm

- Extração nut eixos dianteiros.



## CHAVE EXTRAÇÃO RODA NUT SCANIA

**52926** 201,00€

2,75 - 8 1500



100mm

8 CANTOS

CUADRADO 3/4"

- Extração nut eixos traseiros.



## CHAVE AMORTECEDOR TRASEIRO SCANIA

**52927** 59,00€

0,78 - 20 1000



34x56mm

CUADRADO 3/4"



## CHAVE RODA DIANTEIRA SCANIA

**52928** 172,00€

1,90 - 10 1500



80mm

8 CANTOS

CUADRADO 3/4"

- Extração nut eixo dianteiro.



## CHAVE DE PORCA DE RODA SCANIA

**52929** 185,00€

2,68 - 6 1500



95mm

8 CANTOS

CUADRADO 3/4"

- Extração nut hub terceiro eixo de caminhão eixos 10.



## INSTALADOR PARA VIRABREQUIM TRASEIRO RETENTOR ÓLEO SCANIA

**52930** 117,00€

2,86 - 4 1500



SCANIA 310/320

RETENTOR 0366303-R



## CHAVE CAMINHÃO SCANIA ROTAÇÃO EIXO DE COMANDO

**52931** 45,00€

0,23 - 10 500



CUADRADO 1/2"



## CHAVE PARA VÁLVULA DE INJEÇÃO ELECTROMAGNÉTICA SCANIA

**52932** 45,00€

0,47 - 20 1500



Ø 38mm

CUADRADO 1/2"



## CHAVE 8 ALMENAS SCANIA

**52933** 194,00€

3,15 - 6 504



SCANIA 420

8 ALMENAS

CUADRADO 3/4"

Ø Exterior: 11,6cm  
Ø Interior: 10cm



# CHAVES PARA VEÍCULOS PESADOS

## CHAVE DE BUCHA PARA IVECO

**53430** 286,00€

- Utilizado com uma tomada ou chave de 36mm.

2,95 - 8 280  
Kg SUB ff

Ø Exterior: 134mm  
Ø Interior: 110,5mm  
IVECO  
12 FACES  
118x134mm



## CHAVE DE PORCA DE CAMINHÃO BENZ/MAN

**52935** 94,00€

0,91 - 10 1000  
Kg SUB ff

60mm CUADRADO 3/4"



## CHAVE EIXO TRASEIRO CAMINHÃO BENZ/MAN

**52936** 199,00€

- Útil em vans.

1,58 - 10 1500  
Kg SUB ff

80-95mm 6 ALMENAS  
CUADRADO 3/4"



## CHAVE EXTRAÇÃO HUB TRASEIRO CAMIÓN BENZ / MAN

**52937** 265,00€

- Extração hub eixo dianteiro.

3,05 - 6 1500  
Kg SUB ff

95-115mm 6 ALMENAS  
CUADRADO 3/4"



## CHAVE EXTRAÇÃO EIXO DIREÇÃO BENZ / MAN

**52938** 199,00€

- Extração de nut del eixo de endereço.

3,22 - 6 1500  
Kg SUB ff

100mm 6 ALMENAS  
CUADRADO 3/4"



## CHAVE PARA EXTRAÇÃO DE VÁLVULA DE INJEÇÃO DIESEL BENZ/MAN

**52939** 28,00€

0,20 - 30 1500  
Kg SUB ff

22-28mm 4 ALMENAS  
CUADRADO 3/4"  
DIESEL



## CHAVE PARA NUT DIFERENCIAL TRASEIRO BENZ/MAN

**52940** 235,00€

4,34 - 4 1500  
Kg SUB ff

101mm 6 ALMENAS  
CUADRADO 3/4"



## CHAVE ROTAÇÃO VOLANTE DO MOTOR BENZ E MAN 2 ENGRÊNAGENS

**52941** 70,00€

- Para Benz de 6, 8 e 10 cilindros.  
- Para MAN de 12 cilindros.

0,54 - 20 1500  
Kg SUB ff

CUADRADO 1/2"



## CHAVE ROTAÇÃO VOLANTE BENZ Y MAN 3 ENGRÊNAGENS

**52942** 105,00€

- Para Mercedes Actros e Atego.  
- Para MAN de 5,6 e 8 cilindros.

0,87 - 20 960  
Kg SUB ff

CUADRADO 1/2"



## CHAVE ROTAÇÃO VOLANTE DE MOTOR MAN

**52943** 75,00€

0,49 - 30 1500  
Kg SUB ff

CUADRADO 1/2"



## EXTRACTOR DE CABEÇA DE CAMINHÃO

**52944** 110,00€

1,00 - 20 1500  
Kg SUB ff

30mm  
CUADRADO HEXAGONAL 19mm



## EXTRACTOR DE PORCA DE CAMINHÃO E VEÍCULOS COMERCIAIS

**52945** 281,00€

2,74 - 24 960  
Kg SUB ff

39mm  
CUADRADO HEXAGONAL 26mm



## CHAVE PORCA HUB PARAFUSOS CAMINHÃO BENZ/MAN

**52934** 102,00€

1,05 - 12 1000  
Kg SUB ff

56mm  
CUADRADO 3/4"







# **CARROÇARIA**

- 160 PARA CARROÇARIA
- 161 PARA FARÓIS
- 162 CAPACETES DE SOLDAGEM  
/ CONJUNTOS DE ALAVANCAS
- 163 JOGO PARA ABRIR CARROS  
/ SUBSTITUIÇÃO DE PARA-BRISAS
- 164 MORDAÇAS
- 166 PISTOLAS DE SILICONE / VENTOSAS
- 167 FITAS DE FIXAÇÃO / CARROS E ARMAZENAMENTO
- 168 CAVALETES / SUPORTES
- 170 MANUTENÇÃO DE VEÍCULOS / EXPOSITORES
- 171 ESTRADOS
- 172 PLATAFORMAS DE ALUMÍNIO

## KIT REPARADOR DE AMOLGADELAS

53224 142,00€

32  
PCS

AUDI

3,90	-	5	35
Kg	sub	ff	ff

- 1 pistola de cola (220-240V ~, 50Hz, 40W).
- 1 martelo deslizante para a extracção de amolgadelas profundas.
- 1 levantador de amolgadelas para a extracção de amolgadelas ligeiras em superfícies planas.
- 1 limpador de cola.
- 1 rasgador para a extracção suave das linguetas para cola.
- 8 barras de cola preta (11 x 200mm).
- 19 linguetas para cola em vários tamanhos e formas.



### DESMANCHA DISPONÍVEL

REF.	DESCRIÇÃO	Kg	sub	ff	ff	€
13842	Saco de 5 discos azuis	0,15	10	100		8,50€
13843	Saco de 4 discos amarelos	0,1	10	100		7,00€
13844	Saco de 10 discos vermelhos	0,3	10	50		9,00€
13845	Saco de 5 barras de cola	0,02	10	100		8,00€



## ECRÃ PARA INSPEÇÃO DE AMOLGADELAS

53486 29,30€

0,30	10	40	160
Kg	sub	ff	ff

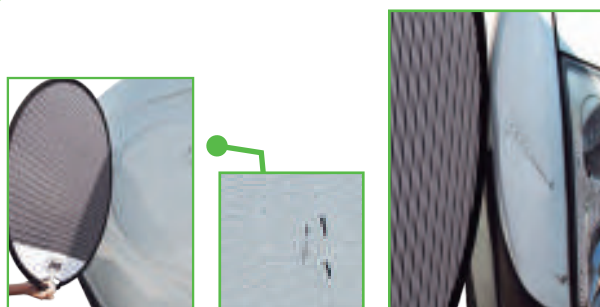

Ø 800mm

## PUNÇÕES

Permitem a aplicação de marcação digital ou alfabética em qualquer superfície de metal por método de indentação ou impacto. A área de trabalho arredondada evita rachaduras ou fraturas na superfície tratada.

### LETRAS E NÚMEROS

52422 24,70€

0,82	3	6	540
Kg	sub	ff	ff



5mm A-Z & 0-9

53119 52,00€

194	3	6	504
Kg	sub	ff	ff



8mm A-Z & 0-9

### NÚMEROS

52882 14,00€

0,30	10	60	1500
Kg	sub	ff	ff

1/4"

9  
PCS



6mm 0-8

## KIT ENCONTRADORES PARA CHAPEIROS

52876 182,00€

3,13	-	6	84
Kg	sub	ff	ff



REVESTIDO DE PLÁSTICO



7  
PCS

### DESMANCHA DISPONÍVEL

REF.	DESCRIÇÃO	Kg	sub	ff	ff	€
12955	Encontrador tipo bigorna	0,29	-	25	99	27,80€
12956	Encontrador tipo rail	0,31	-	25	99	27,80€
12957	Encontrador tipo	0,37	5	25	99	27,80€
12958	Tas mango con cuña	0,41	-	25	-	27,80€
12959	Tas en coma	0,3	5	25	99	27,80€
12960	Tas de tacón	0,18	-	25	1500	27,80€
12961	Tas de coma con mango	0,34	-	25	-	27,80€



# CONJUNTO DE RESTAURAÇÃO DE FARÓIS

**53673** 80,00€

2,00	-	10	80
Kg	sub	ff	ff

- O kit de reparo de faróis de polímero líquido é um sistema inovador para restaurar os faróis queimados até a sua condição original com um brilho original e uma aparência perfeita de uma maneira muito rápida e econômica.

- Complete:
  - Recipiente para líquido de 600 ml
  - 6 folhas de lixa
  - Papel texturizado
  - Funil de plástico
  - Tampa curva com anel de vedação de borracha
  - Tampa plana com anel de vedação de borracha
  - Adaptador ac-dc
  - Adaptador 12v
  - Copo de evaporação
  - Placa de moagem



**15375** 28,00€

0,80	4	24	600
Kg	sub	ff	ff

**GARRAFA COM LÍQUIDO 600ml**

O kit de reparo de faróis de polímero líquido é um sistema inovador para restaurar os faróis queimados até a sua condição original com um **brilho original e uma aparência perfeita.**



**BRILHO ORIGINAL E UMA APARÊNCIA PERFEITA**



## DESMANCHA DISPONÍVEL

REF.	DESCRIÇÃO	Kg	sub	ff	ff	€
14564	Kit de 6 papéis abrasivos	0,10	10	100		9,20€
14565	Adaptador ac-dc	0,20	10	50		26,70€
14566	Adaptador 12v	0,05	10	100		16,70€
14567	Copo de evaporação	0,15	10	20		38,00€
14568	Tampa curva com anel de vedação de borracha	0,1	10	200		9,20€
14569	Tampa plana com anel de vedação de borracha	0,1	10	200		9,20€
14570	Funil	0,01	10	200		4,05€
14571	Placa de moagem	0,05	-	100		9,20€
14573	Papel texturizado	0,70	10	100		4,05€
15375	Garrafa com líquido 600ml	0,01	4	24		28,00€

## CONJUNTO DE 10 ELEMENTOS DO PAPEL ABRASIVO

GRÃO	REF.	DESCRIÇÃO	Kg	sub	ff	ff	€
180	14710	0,25	3,50€				
280	14711	0,20	3,75€				
360	14712	0,20	4,00€				
600	14713	0,15	4,25€				
800	14714	0,15	4,50€				
1200	14715	0,10	4,75€				

## CONJUNTO DE MARTELOS ESPECIAIS PARA CHAPA

**51131** 61,00€

5,00	-	5	100
Kg	sub	ff	ff



**7 PCS**

## DESMANCHA DISPONÍVEL

REF.	DESCRIÇÃO	Kg	sub	ff	ff	€
11541	Martelo boca plana	0,43	5	25		11,00€
11542	Martelo boca plana/peña	0,38	5	25		11,00€
11543	Martelo boca plana cônica	0,42	5	25		11,00€
11544	Tas tacão	0,69	5	25		7,00€
11545	Tas aleta	0,79	5	25		11,00€
11546	Tas dois cantos romo	0,81	5	25		12,00€
11547	Tas cunha em 8 o carril	0,81	5	25		12,00€

## KIT DE RESTAURAÇÃO DE FARÓIS

**53626** 18,00€

0,30	-	12	576
Kg	sub	ff	ff

- Projetado para restaurar a clareza das lentes dos faróis que ficaram amarelas, nubladas ou turvas.
- Melhora o desempenho das lentes dos faróis.
- Três passos simples: lixar, polir e proteger.
- Restaura faróis dianteiros, lanternas, faróis de neblina ou sinais de direção.
- Este kit é feito para restaurar 2 faróis.



- Conteúdo del kit:
  - 2x P800 Discos de lixar.
  - 2x P1200 Discos de lixar.
  - 2x P2000 Discos de lixar.
  - 1x 85gm Pasta de polimento.
  - 2x 3,0ml Líquido protetor UV.
  - 1x Fita adesiva.
  - 1x Disco de polimento de lã.
  - 1x Disco de Esponja Branco.
  - 1x Almofada de suporte M10 Rosca.
  - 2x Adaptador (3/8" & 1/4").

**EM EXPOSITOR DE 12 UDS**



## DESMANCHA DISPONÍVEL

REF.	DESCRIÇÃO	Kg	sub	ff	ff	€
14286	Almofada esponjosa macia	1,95	-	200		2,99€
14287	Almofada esponjosa dura	2,30	-	200		2,99€
14288	Almofada de lã	2,30	10	200		6,00€
14289	Disco velcro	7,40	-	200		6,10€
53646	3º Conjunto para a máquina de polimento pneumática	8,95	5	10		62,00€

## KIT ESPECIAL POLIMENTO: MÁQUINA POLIMENTO NEUMÁTICA + 12 KIT RESTAURAÇÃO DE FARÓIS

**SERIE262** 199,00€



IVA não incluído

## CAPACETE PARA SOLDAGEM COM REGULADOR MANUAL

53414 49,00€

0,85	-	6	36
Kg	Sub	ff	ff



REGULADOR MANUAL

## CAPACETE PARA SOLDAGEM COM REGULADOR DIGITAL

53415 188,00€

0,95	-	4	40
Kg	Sub	ff	ff



ESCURECIMENTO AUTOMÁTICO

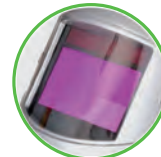

REGULADOR DIGITAL

## JOGO DE 4 ALAVANCAS EXTRALARGAS

52977 137,00€

8,50	-	1	42
Kg	Sub	ff	ff

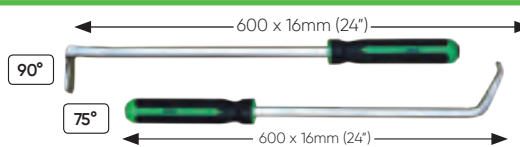
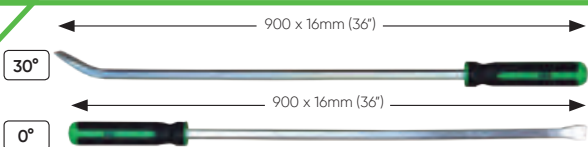

## JOGO 27 ALAVANCAS DE NYLON

52788 39,00€

1,18	27	10	170
Kg	Sub	ff	ff



27 PCS

- Set 27 alavancas com diferentes curvaturas e terminações que facilitem o trabalho tanto em ambientes internos e ao ar livre de veículos. A sua vasta gama permite que você use a ferramenta certa para cada trabalho e peça, facilitando o trabalho em locais de difícil acesso.

## JOGO DE 5 ALAVANCAS DE NYLON

50901 16,00€

0,30	5	20	240
Kg	Sub	ff	ff

- Universal
- Com punho
- Uso práctico
- Especiais zonas estreitas

- Topicerias
- Medidas: 6 x 160mm, 63 x 175 mm, 30 x 200mm, 20 x 180mm, 20 x 215mm



## JOGO DE 4 ALAVANCAS DE NYLON TIPO FACIA

51832 18,00€

0,50	12	24	192
Kg	Sub	ff	ff



19x273, 22x273, 25x273, 38x273mm



## JOGO DE 5 ALAVANCAS DE FERRO

50903 30,80€

1,90	4	8	200
Kg	Sub	ff	ff

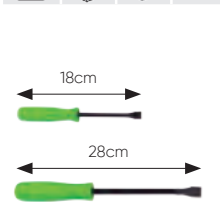

60, 43, 38, 28, 18cm



## JOGO DE 2 ALAVANCAS DE FERRO

52026 31,80€

2,04	5	10	240
Kg	Sub	ff	ff

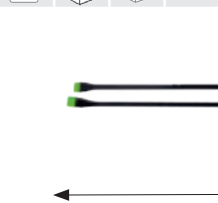

90cm

## PÉ-DE-CABRA

51360 8,05€

0,80	5	20	900
Kg	Sub	ff	ff

18" x 5/8

1,46	5	10	500
Kg	Sub	ff	ff

24" x 3/4

FABRICADO EM AÇO





## JOGO 2 ALAVANCAS PARA EXTRAÇÃO DE GRAMPOS

**52851** 9,65€

0,35	6	60	600
Kg	sub	ff	ff



## JOGO DE 6 ALAVANCAS

**53110** 27,30€

1,42	6	12	168
Kg	sub	ff	ff

5"x8.5 / 5"x10.3  
5"x4.5 / 15"x8.5  
15"x10.3 / 15"x4.5mm

**6**  
PCS

240mm  
490mm



## JOGO DE UTENSÍLIOS PARA ABRIR CARROS

**53230** 19,70€

0,65	6	24	288
Kg	sub	ff	ff

**UNIVERSAL** **8**  
PCS

- Kit de ferramentas especiais para abrir veículos sem chave.
- Composto por cunhas de plástico, alavancas e ganchos curvos.
- Contém chave universal para coberturas de depósito de combustível.
- Para uso em oficinas e assistências.

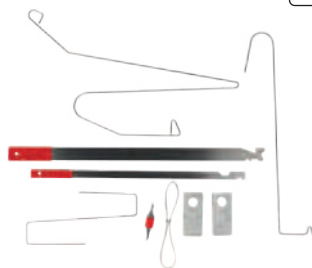

## KIT DE 4 ALMOFADAS INFLÁVEIS

**52077** 29,50€

0,35	5	40	400
Kg	sub	ff	ff

40-50mm

- Introdução entre o vidro e a porta, permite abrir o veículo facilmente sem estragar.

- Contém:  
Almofada de 16x16cm  
Almofada de 32x12cm  
Almofada de 19x6cm  
Almofada de 18x4,5cm  
Bomba manual



- Pressão máxima suportada: 100kg

PARA REF. 53232

### CABO PARA EXTRAÇÃO DE PÁRA-BRISAS

**13813** 7,00€

0,10	10	60	1200
Kg	sub	ff	ff



### FERRAMENTA PARA EXTRAÇÃO DE PÁRA-BRISAS

**13814** 11,00€

0,20	10	60	1080
Kg	sub	ff	ff



## FERRAMENTAS PARA SUBSTITUIÇÃO DE PARA-BRISAS

**53232** 39,00€

1,15	-	10	180
Kg	sub	ff	ff

- Contém:  
1x útil extrator de molduras.  
1x alavanca para extrair a borracha.  
1x gancho extrator.

- 1x 1,8m de fio de corte.  
2x cabos para o fio de corte.  
1x Passa-cabos.



## ESQUADRO MAGNÉTICO 45°, 90°, 135°

**54111** 4,75€

0,35	10	40	1680
Kg	sub	ff	ff

75mm

**54113** 7,65€

0,60	10	20	1100
Kg	sub	ff	ff

100mm



## 5 CHAVES HEXAGONAIS 3/8" - EXTRA LONGOS

**53545** 35,70€

0,74	5	20	600
Kg	sub	ff	ff

8, 10, 12, 13, 14mm

**Cr-V** BMW, FORD, OPEL, VAG, VAUXHALL

- Permite ajustar o freio de estacionamento em BMW, FORD OPEL, VAG e VAUXHALL.
- Útil para dobradiças de porta, pára-choques e luzes traseiras. Também é usado para freios de mão.

**5** **3/8"**  
PCS



120mm



IVA não incluído

# MORDAÇAS

0,90	10	20	300
Kg	sub	ff	ff

## DIRECTAS

**53675** 50,00€  
0,75 Kg

## CURVAS

**53676** 44,00€  
0,85 Kg

## ALMOFADA GIRATÓRIA

**53677** 55,00€  
0,90 Kg

## CURVAS LONGAS

**53678** 52,00€  
0,90 Kg

10"

REF	←	→
53675	250mm	70mm
53676	250mm	90mm
53677	250mm	80mm
53678	300mm	105mm



EM EXPOSITOR DE 10 UDS

## JOGO 3 MORDAÇAS PRESSÃO EXTRA-LARGAS

**52982** 53,00€

1,60	4	8	384
Kg	sub	ff	ff

37cm: ponta recta  
36cm: ângulo de 45°  
34cm: ângulo de 90°

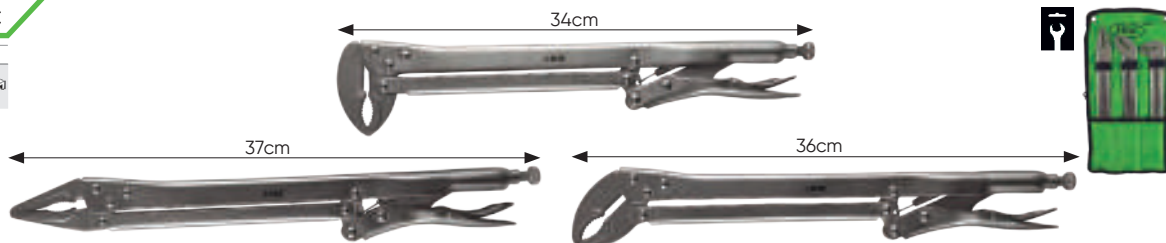

## MORDAÇAS PRESSÃO

**50577** 12,60€

0,53	5	40	-
Kg	sub	ff	ff

CrV 280mm



## MORDAÇAS DE PRESSÃO CURVADO

**52386** 23,60€

0,44	10	50	1500
Kg	sub	ff	ff

**52386** LISO



**52387** DENTADO



**52387** 24,50€

0,44	10	50	1000
Kg	sub	ff	ff

CrMo

215mm

- Agarre em 6 medidas distintas de fêmea / parafuso hexagonal.

## JOGO DE 6 ALICATES MORDAÇAS

**52385** 251,00€

3,72	-	6	120
Kg	sub	ff	ff



TIPO W 195mm

**14103** 32,40€



TIPO T 215mm

**14104** 32,40€



TIPO L 225mm

**14105** 32,40€



TIPO J 210mm

**14106** 32,40€



TIPO LL 195mm

**14107** 32,40€



TIPO JJ 195mm

**14108** 32,40€



## MORDAÇA PRESSÃO PESCOÇO DE CISNE

**52505** 20,80€

0,27	36	72	2160
Kg	sub	ff	ff

Apresentação em caixa



170mm

CrMo

0-40mm



## MORDAÇA PRESSÃO PESCOÇO DE CISNE, MAXILAS OSCILANTES

**52506** 16,00€

0,28	36	72	2160
Kg	sub	ff	ff

Apresentação em caixa



170mm

CrV

0-50mm



## MORDAÇA DE PRESSÃO SOLDADURA, MÁXILAS OSCILANTES

**52512** 50,00€

1,31	-	20	280
Kg	sub	ff	ff

Apresentação em caixa



440mm

CrMo

0-210mm





### MORDAÇA DE PRESSÃO PARA SOLDADURA

**52511** 42,00€

440mm

1.31 - 20 280

Kg SUB ff

CrMo

- Apresentação em caixa



### MORDAÇA DE PRESSÃO PARÁGRAFO LATOEIROS

**52507** 30,10€

250mm

0.77 5 30 420

Kg SUB ff

CrMo

- Apresentação em caixa



### MORDAÇA DE PRESSÃO TIPO U

**52504** 27,60€

225mm

1.14 - 30 480

Kg SUB ff

CrMo

- Apresentação em caixa



### MORDAÇA DE PRESSÃO PESCOÇO DE CISNE MAXILAS OSCILANTES

**52503** 32,50€

280mm

0.85 10 30 540

Kg SUB ff

CrMo



### MORDAÇA ESPECIAL SOLDADURA

**52390** 35,20€

250mm

0.50 5 40 640

Kg SUB ff

CrMo



### MORDAÇA DE PRESSÃO PARA SOLDADURA

**52502** 31,40€

280mm

0.84 10 30 540

Kg SUB ff

CrMo



### MORDAÇA DE PINÇA

**52477** 70,00€

2T

2.65 - 6 1500

Kg SUB ff

0-60mm

CrMo



### MORDAÇA 90°

**52478** 49,00€

5T

2.90 - 10 1500

Kg SUB ff

0-20mm

CrMo



### MINI MORDAÇA PLANO 90°

**52479** 24,70€

3T

1.18 - 30 1500

Kg SUB ff

0-20mm

CrMo



### MORDAÇA DE ARGOLA

**52474** 68,00€

6T

3.49 - 5 1500

Kg SUB ff

0-20mm

CrMo



### MORDAÇA PLANO

**52475** 62,00€

3T

3.60 - 10 1500

Kg SUB ff

0-25mm

CrMo



### MORDAÇA QUADRADO

**52476** 50,00€

5T

3.10 - 10 1500

Kg SUB ff

0-25mm

CrMo



### MINI MORDAÇA QUADRADO 90°

**52480** 44,00€

3T

2.00 - 10 1500

Kg SUB ff

0-25mm

CrMo



### MORDAÇA QUADRADO

**52481** 52,00€

3T

2.05 - 9 1500

Kg SUB ff

0-20mm

CrMo



### MORDAÇA PLANO ÂNGULO 45°

**52482** 44,00€

5T

2.13 - 8 1500

Kg SUB ff

0-10mm

CrMo



### MORDAÇA PLANO MINI

**52483** 41,00€

3T

2.02 - 12 1500

Kg SUB ff

0-10mm

CrMo



### MORDAÇA DE PINÇA

**52487** 63,00€

5T

2.27 - 7 1000

Kg SUB ff

0-20mm

CrMo



### UNIÃO DE CORRENTES

**52484** 66,00€

3T

1.19 - 11 1500

Kg SUB ff

0-110mm

CrMo



### UNIÃO DE GANCHOS

**52485** 51,00€

4T

1.17 - 30 1000

Kg SUB ff

0-90mm

CrMo



### UNIÃO DE CORRENTES GANCHOS

**52486** 62,00€

3T

1.21 - 11 1500

Kg SUB ff

0-110mm

CrMo



## PISTOLA DE SILICONE PROFSSIONAL

52533 10,00€

0.74	12	24	144
Kg	sub	ff	ff



9"

300ml

## PISTOLA DE SILICONE PNEUMÁTICA

53567 43,00€

1.05	-	10	180
Kg	sub	ff	ff



- Pressão de trabalho: 2,5-5 BAR.
- Entrada de ar: 1/4".
- Capacidade do cartucho: 310ml.

310ml



## FERRAMENTA DE VEDAÇÃO DE SILICONE

54017 12,00€

4.60	5	20	240
Kg	sub	ff	ff



Este kit permitirá que você restaure a lacuna e remova resíduos de adesivo, além de melhorar a aderência e a aparência da superfície.

- Um raspador de aço inoxidável remove o adesivo antigo
- Espátula de silicone remove saliências e amassados na superfície.
- A ferramenta é adequada para alisar juntas e linhas de vedação e vai lidar com a maioria dos produtos de silicone, quaisquer bordas, cantos e costuras



Inclui cinco almofadas de silicone de reposição (3R, 6R, 10R, 13R, 17R)



Esta ferramenta pode ser usada para casa, cozinha, banheiro, janelas, conexões de pia, etc.

## KIT DE DUAS MINI VENTOSAS

52295 6,50€

0.15	10	100	1200
Kg	sub	ff	ff



## VENTOSA EXTRAÇÃO COM CABO

52589 13,00€

0.28	10	40	640
Kg	sub	ff	ff



## VENTOSAS

### ÚNICA

52262 7,50€

0.31	12	48	384
Kg	sub	ff	ff



### DUPLA

52263 13,50€

0.59	6	24	192
Kg	sub	ff	ff



### TRIPLE

52264 18,60€

0.92	6	10	100
Kg	sub	ff	ff



### QUADRÚPLA

52265 30,50€

1.24	-	10	100
Kg	sub	ff	ff



## VENTOSA DUPLA ARTICULADA

52765 21,70€

0.72	5	20	80
Kg	sub	ff	ff



- Destinase a manutenção, instalação e remoção de partes do veículo, tanto a folha de metal e vidro.
- Facilidade de manipulação e se conforma com a curvatura do potencial de superfície.



## JOGO DE VENTOSO E CATRACA

52998 48,00€

2.03	-	8	112
Kg	sub	ff	ff





## CINTA DE APERTO POLIÉSTER COM TENSOR

**52321** 8,80€

0,35 5 20 1200

Kg SUB 1f 1f

5m x 25mm

**52327** 12,00€

0,46 5 20 1000

Kg SUB 1f 1f

8m x 25mm



## SUPORE DE PEÇAS - PÁRA-BRISAS E COBERTURA

**53983** 215,00€ - Disponível para pára-brisas, chapas metálicas, capôs, portas ... etc.

19,40 - 1 35

Kg SUB 1f 1f

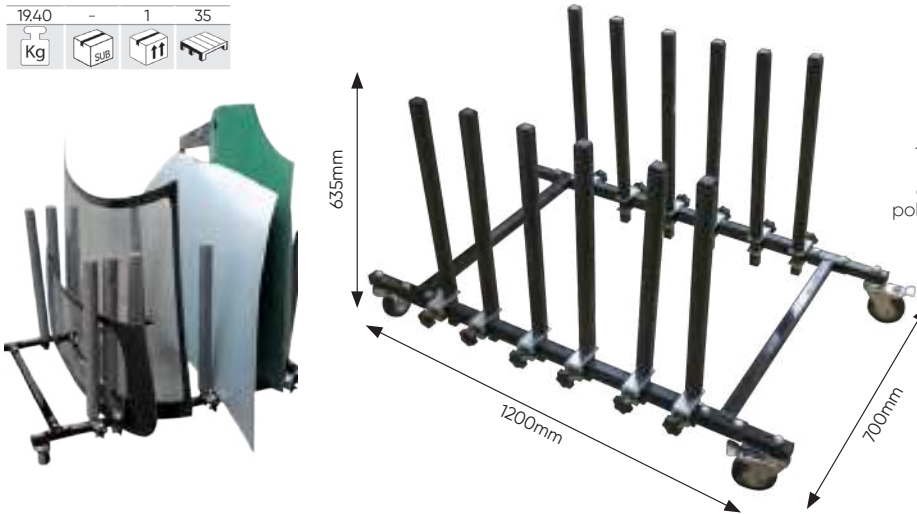

12 hastes de 630 mm cobertas com espuma de polietileno expandido (EPE)

Até 5 grandes painéis ou vidros

150 KG

Rodas de poliuretano (PU) 4 "x 4" (duas giratórias com freio)

## CARRO PARA ARMAZENAGEM DE PEÇAS

**53125** 477,00€

51,00 - 1 12

Kg SUB 1f 1f

1.800mm 895mm 585mm



200 KG

4x INCLUÍDO

## CAVALETE UNIVERSAL TELESCÓPICO

**53124** 287,00€

21,10 - 1 11

Kg SUB 1f 1f

100 KG



MEDIDAS ALTO

↑ 1.320mm  
↓ 840mm

MEDIDAS LONGA

↑ 1.380mm  
↓ 225mm



## CARRO TRANSPORTADOR ESPECIAL CHAPEIROS

**50923** 454,00€

36,40 - 1 18

Kg SUB 1f 1f

480mm 1.300mm 800mm

CE 340 KG

- Separação de 0 a 110 cm.



RODAS PARA REF. 50923

12022 33,70€

IVA não incluído

**JBM** / [www.jbmcamp.com](http://www.jbmcamp.com)

## CAVALETE PARA PARABRISA

53080

99,00€

1,130mm

990mm

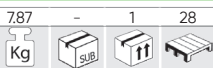

MEDIDAS DOBRADO

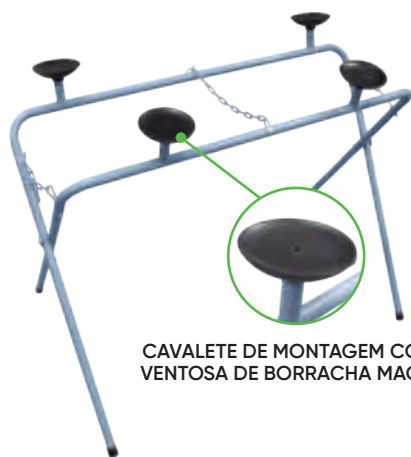

CAVALETE DE MONTAGEM COM VENTOSA DE BORRACHA MACIA

## CAVALETE PROFESSIONAL

52749

79,00€

80mm

58mm

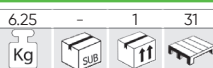

FOAM PARA PREGUIÇA REF. 52749

11959

10,50€

0,08

100



## CAVALETE EN "X"

53079

89,00€

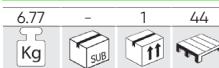

MEDIDAS DESDOBRADO

660mm

600mm

870mm

MEDIDAS DOBRADO

1140mm

600mm

300mm



## CAVALETE SUPORTE PARA-CHOQUES

53736

98,00€

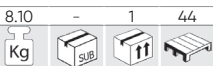

- Ideal para fixar pára-choques, para pintar e repará-los com maior conforto.

- Largura ajustável: 75 cm - 160cm.  
- Altura máxima: 148cm.



A LARGURA AJUSTÁVEL PERMITE QUE O SUPORTE SEJA ADEQUADO PARA SUPORTAR VÁRIOS TIPOS E ESTILOS DE PÁRA-CHOQUES



AÇO

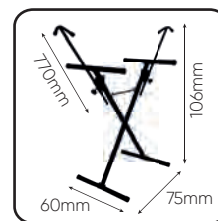

53685

310,00€

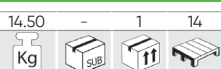

1,110mm

760mm

1,340mm

- Sustenta qualquer para-choque sem tocar na superfície pintada  
- Facilita e agiliza os reparos e pinturas  
- Giro de 90 graus permite fácil acesso a todas as superfícies  
- Cinco posições diferentes de bloqueio  
- Cuatro rodas de qualidade industrial, com bloqueio total para a estabilidade



AJUSTE DOS BRAÇOS DE SUPORTE DE 134 - 198cm

AÇO COM COBERTURA DE PÓ

4 RODAS DE 4 POLEGADAS (DUAS GIRATÓRIAS COM TRAVÃO)





## SUPOORTE PARA PINTURA AJUSTÁVEL

53134 144,00€



- 6 ganchos para segurar peças para pintar ou secar.
- Marco ajustável que se estende de 127 cm a 203 cm.

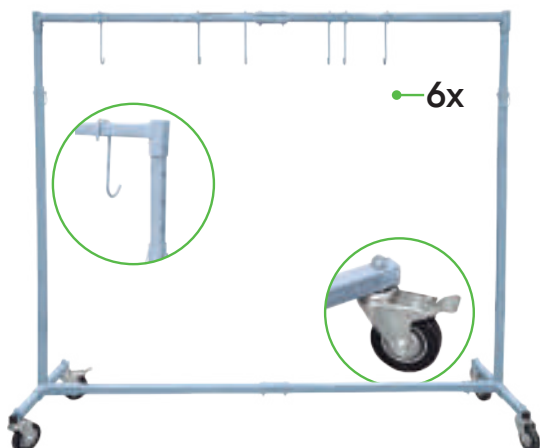

## SUPOORTE BASCULANTE PARA PINTURA

53126 243,00€



- Ideal para portas, capôs, pára-choques, alertas, spoilers, etc.

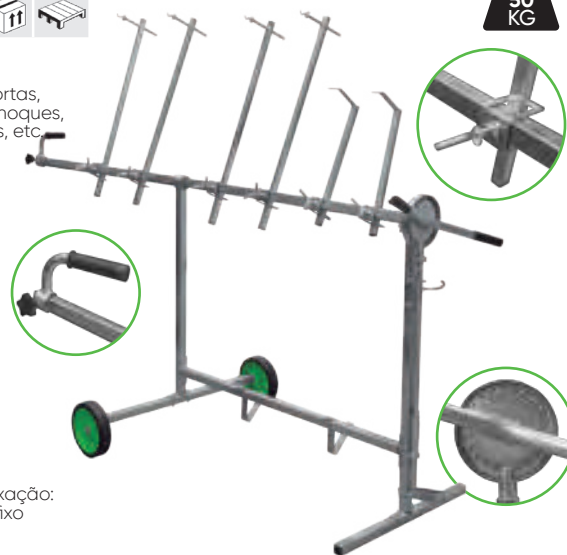

- 6 braços de fixação: 4 com gancho fixo 2 com buraco

## SUPOORTE DE PAPEL PARA PAREDE

53922 29,00€



PAPEL NÃO INCLUSO

- Aço inoxidável
- Rolo: max. largura 38 cm
- Braçadeira-plástico ABS, cinzento.

- Parafusos e porcas de fixação em aço inoxidável.

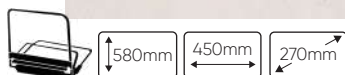

## PORTA ROLO DE PAPEL

53921 39,00€

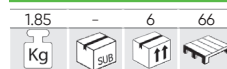

PAPEL NÃO INCLUSO



- Material: aço inoxidável
- Rolo: max. largura 38 cm
- Braçadeira - plástico ABS



## ROLO COBRE ASSENTOS

MODELO CUIDAMOS (CASTELHANO) / SEM SAIA

51978 84,00€



25mc 250 u.



25 MICRONS DE ESPESSURA

MODELO DESENHO ANÔNIMO / SEM SAIA

52244 84,00€



25mc 250 u.



## KIT SUPORTES + MATERIAL DE CUIDADO DO VEÍCULO

COMPOSTO POR REF. 52065, 52244, 52057, 52058

50403 98,00€



COMPOSTO POR REF. 51985, 52244, 52057, 52058, 50409

50410 168,00€



COMPOSTO POR REF. 51985, 51978, 52057, 52058, 50409

50400 168,00€



## SUPORE DE PAREDE PARA ROLO COBREASSENTOS, ROLO VOLANTE E TAPETES DE PAPEL

**53705** 80,00€

4,90	-	1	28
Kg	Sub	ff	

**51985** 84,00€

4,85	-	1	28
Kg	Sub	ff	



- Suporte da tampa do pé.
- Suporte da tampa do assento.
- Suporte para lidar com a tampa do filme.



## SUPORE DE PAREDE DE ROLO COBRE-ASSENTO

**52065** 45,00€

2,19	-	1	77
Kg	Sub	ff	

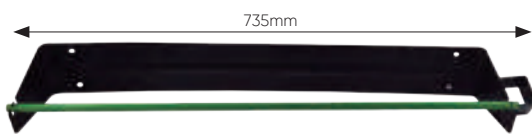

## ROLO DE COBERTURA PARA VOLANTE

FILM

**52057** 6,80€

0,62	-	24	672
Kg	Sub	ff	

- Comp. 200m
- Larg. 12,5cm
- Grosso: 23mc

CABO

**52058** 4,50€

0,06	-	125	2500
Kg	Sub	ff	



## TAPETE ANÔNIMO EM PAPEL

**50409** 26,00€

3,54	-	1	160
Kg	Sub	ff	

UDS  
PACK



250 UDS

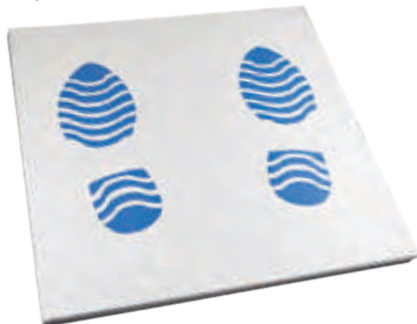

## PROTECTOR DE VOLANTE PLÁSTICO

**51824** 36,80€

1,45	-	8	72
Kg	Sub	ff	

250 UDS



## KIT MANUTENÇÃO DE LIMPEZA EM BOLSA INDIVIDUAL

**50916** 0,88€

0,05	100	400	3200
Kg	Sub	ff	

DISPENSADOR

5in1



20mc



TAPETE PARA  
PÉS DE PAPEL



## CAPA PARA ASSENTO DE CARRO

**53226** 14,90€

0,20 5 50 600

Kg SUB 11 11

- Nylon.  
- Universal.

51cm 26,5cm 14mm



## PROTECTOR COM IMÁN

**51622** 25,30€

0,45 - 30 540

Kg SUB 11 11

110cm 64cm



4 PONTOS  
MAGNETIZADOS

DUAS FACES:  
UM VELUDO /  
UM PLÁSTICO



## VENTOSA PNEUMÁTICA COM MARTELO DESLIZANTE

**52540** 221,00€

4,36 - 3 72

Kg SUB 11 11

- Ventosa com martelo pneumático deslizante para tirar mossas.  
- O seu desenho permite tirar mossas de uma maneira rápida e fácil.

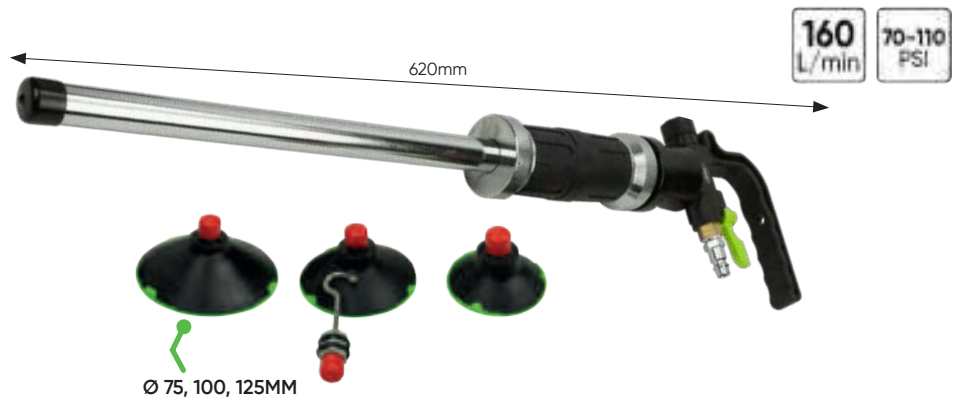

## ESTRADO EM ESPUMA

DESDOBRÁVEL

**53192** 52,00€

0,70 - 2 48

Kg SUB 11 11

- De espuma EVA.  
- Medições do colchão dobrado: 20cm x 42cm x 18cm

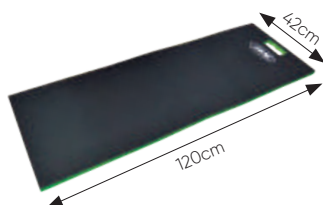

INDIVIDUAL

**53191** 14,80€

0,15 - 5 140

Kg SUB 11 11



- De espuma EVA.

32cm 48cm 18mm



IVA não incluído

## PLATAFORMA DE ALUMÍNIO TELESCÓPICA

52230 398,00€

CUMPRE COM: EN 131

16,75	-	1	14
Kg	sub	ff	

150 Kg

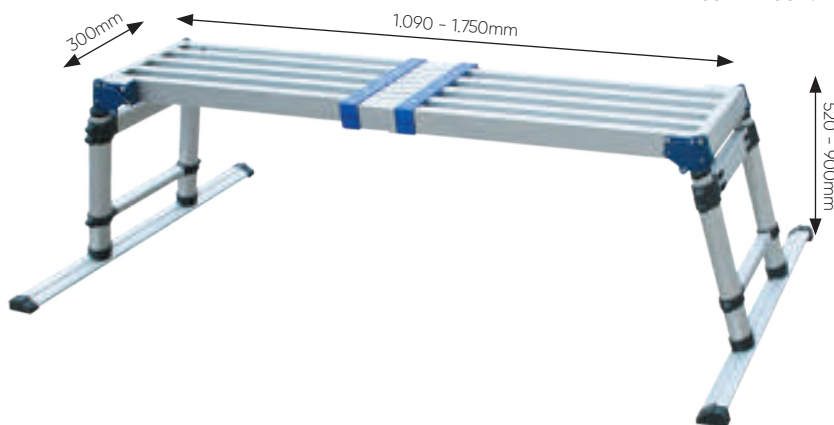

- Largura da plataforma: 300mm.
- Altura ajustável da plataforma: 520-900mm.
- Largura da barra: 40mm.
- Distância entre as barras: 250mm.

- Posições: 42 (14 de horizontais x 3 de verticais).
- Altura 1 : 520mm.
- Altura 2 : 700mm.
- Altura 3 : 900mm.



SUPER LEVE

DOBRAGEM



FÁCIL MONTAGEM

PÉ DE RECAMBIO PARA PLATAFORMA REF. 52230

10966 0,06 1  
13,50€ Kg ff

PROTECTOR CANTOS PLATAFORMA REF. 52230

10965 0,01 1  
6,00€ Kg ff

TIPO DE ESCADA PARA PLATAFORMA REF. 52230

10964 0,01 1  
9,00€ Kg ff

## PLATAFORMA DE ALUMÍNIO GRANDE

50913 195,00€

CUMPRE COM: EN 131

6,50	-	1	20
Kg	sub	ff	

100 Kg



## JOGO DE 2 PLATAFORMAS DE ALUMÍNIO

50656 290,00€

CUMPRE COM: EN 131

10,45	-	1	8
Kg	sub	ff	

100 Kg

PLATAFORMAS DE ALUMÍNIO

15552 181,00€  
550mm 1.300mm 300mm

11897 155,00€  
300mm 1.000mm 300mm

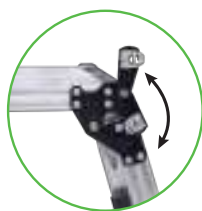

172





## **TRAVÕES**

- 176 REPOSICIONADORES PARA PISTÕES DE FREIO
- 178 REPARAÇÃO / MANUTENÇÃO / SANGRADOS DE FREIO

## PISTOLA PARA POSICIONAR FREIOS PERFIL BAIXO

53683 116,00€

1,45	5	10	100
Kg	Sub	Fit	Box

- Pressão normal de uso: 5-8bar.
- Máxima de trabalho: 14bar.



## PISTOLA PARA POSICIONAR FREIOS

51283 78,00€

1,33	-	10	200
Kg	Sub	Fit	Box

- Pressão normal de uso: 5-8bar.
- Máxima de trabalho: 14bar.



## CONJUNTO DE RECOLHA DE EMBOLOS DE TRAVÕES PNEUMÁTICO

52636 114,00€

3,16	-	5	90
Kg	Sub	Fit	Box

16  
PCS

- 0: GM Maior parte dos Pistões De 2-1/2" de diâmetro (Seville/Eldored 79)  
 2: Citroën Xm/Xantia (F/R), Honda  
 3: Audi (F), Fiat, Alfa Romeo (F), Ford Fies-ta (F), Isuzu (F), Honda Concesto (F), Ja-guar Xj6/Xj40 (F/R), Bmw 318is/320i/325T-d/518i/525i-1x/740i/850Ci/M5 (F), Mercedes Benz 190/200/300/420/560 Serie (F), Mitsubishi Colt (F), Nissan Miera/Stanza/Sunny (F), Rover Austin/Metro200-400 Series/Maestra/Montego (F), Toyota Camry (F), Volvo (F), Vw Passat/Golf Gti (F)  
 4: Ford Australia/Nz Telstar, Mazda (R), Saab 9000 (R)/Lumina, Toyota, Fiat 164 2.0 (R), Alfa Romeo Prelude/Crs 16i, Honda Saturn (R)/Grand Prix, Gm  
 5: Adaptador de 3/8" de diâmetro usado com uma barra de extensão e garra de travacção se for necessário aplicar mais força ao pistão.  
 6: Nissan Primera, VW Golf IV  
 7: Audi 80/90/V8+100/Coupe E (R), Rover 800 Abs, Subaru L+Z (R), Ford Sierra Abs/Granada/Scorpio Abs (R), Nissan Bluebird 1.8 Turbo/Silvia Turbo/

- Primera2.0i Ls-Gs-Gsx (R), Peugeot 405 19Gi/Gri/Sri/Gtxi/Mi 16/605 2.0 Sri (R), Toyota Cecilia/Corolla Gt/Mr2 (R), Vw Golf Gti/Jeta Synchro/Jetta Gti 16V, Passat Cl, Gl, Gt, Gt 16V, Corrado 16V Scirocca Gtx 16V(R), Citroën, Alfa Romeo, Fiat, Honda, Jaguar, Renault, Saab, Seat, Lancia.  
 8: Gm Maior Parte Dos Pistões De 1-7/8" De Diâmetro  
 9: Gm Maior Parte Dos Pistões De 2-1/8" De Diâmetro  
 A (Z): Renault (R21-Laguna (R))  
 E: Nissan Maximas/Cefiro  
 F (G): Opel (Disco Traseiro)/ Fiat Stilo  
 K: Citroën C5  
 M: Ford, Mini Cooper, Nissan Primera 03  
 N: Saab, Honda, Alfa Romeo 164 2.0 Twin Spark/2.0 Turbo (88-)/3.0 V6, Audi 200 (80-)/Coupe Gt Se (82-)/80/90/100/200/Quattro (87-)/90/20V (88-), Ford Mondeo 2.0/Ghia, Lancia Thema1te (85-), Volkswagen Golf Ii Gti (83-87)/Sirotto 16V (84).

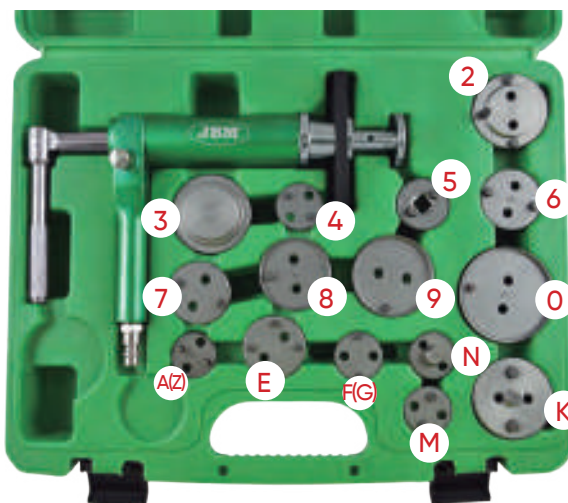

## CONJUNTO REPOSICIONADOR DE TRAVÕES

52330 99,00€

5,68	-	3	54
Kg	Sub	Fit	Box

OPEL  
CITROËN

PEUGEOT  
RENAULT

50  
PCS

- 1pc: Grampo de rotação direita (com rosca à direita)  
 1pc: Grampo de rotação esquerda (com rosca à esquerda)  
 0 disco: Citroën 1: Disco 11: Disco para Jaguar tipo S  
 12: Disco para BMW mini 5: 13/32 " Adaptador (5) com 3/8 Dr. Interior-pt  
 2: Citroën XM, Xantia u.a. 3: Alfa Romeo.Audi. Austin. BMW. Ford. Honda. Jaguar. Mercedes-Benz. Mitsubishi, Nissan Rover, Toyota, VW  
 4: Alfa Romeo 164 2.0.Ford, Mazda, Saab 9000, Subaru  
 6: Nissan Primera, VW-Golf IV  
 7: Audi 8.0,90,V8 +100, Ford Sierra ABS+ Scorpio ab 85, Honda Prelude, Nissan Silvia 1.8 turbo, Rover 8000, Saab 9000, Subaru L+Z, VW-Golf+ Passat  
 8: GM Motors G: Opel 9: GM Motors K: Citroën C5  
 O: GM Motors K1, K2: Citroen, Renault. M: Ford  
 A: Nissan Premira 2.0, Bluebird N: Saab. Honda B: Ford, Lincoln, Subaru Z:  
 Renault C: Mini Austin E: Cefiro, Maxima D: Citroën, Renault  
 F: Peugeot 206 CC/Hdi/Gti. Ela exige uma chave de 16mm com pistões traseiros.  
 P: Audi, BMW, Ford, Lancia, Piston, Renault, Rover  
 J: Alfa Romeo 155 1.8-2.0 164 TD(93) 164 3.0 V6(91), Audi 80,90,A3,A4,A6,A8, Citroen ZX 2 Qi 16V, Fiat Tipo TD 16V, Uno Turbo (85) Crama TD, Ford Sierra ( ABS bak), Granada (85) Crama TD, Ford Sierra (ABS bak), (Australia& NZ) Thunderbird Turbo, Honda CRX, 1.6l-16V (8-90), Accord 1800 (84-85) 2.0i, Prelude 16V (88), Legend V6, Jaguar XJ 4, Oseries, Lancia Dadra 2.0, Ei Tur (93), Delta 1.6 Gti, Nissan, Peugeot, Renault, Seat, Subaru, Volvo V40 &S40.  
 R: Ford( Australia& NZ) Teslar, Laser, Mazda 323 Gti, GTXX (86-), 929 (82 ), RX7(81-), 626 16V(87-) 626 GT (86-), 929 V6 (88-), Mitsubishi Galant GL Si, Toyota Celica, Corolla GT, MR2  
 S: Audi 100 TQ(91), BMW 740i 8cyl (91), Lancia Delta 1.9 TD (95), Proton 416. Renault-most models, Renault Laguna 2.0 (94), Laguna 2.2 D (95) Safrane 2.0-2.2 TD V6, Rover 623 Si, Volkswagen Golf Gtu Mk 1&IV, Passat VR6, Vento GT (92)  
 H6: BMW  
 H7: BMW  
 Pin 3.0  
 Pin 5.5  
 100g Grasa  
 1/2"Dr+10mm Pentagon bit-56mm Sistema de freios  
 1/2"Dr+14mm tipo macho-38mm- para freios pentágono nos freios traseiros do Opel Astra G, Zafira, Smart  
 1/2"Dr+19mm tipo macho-8mm- para freios Bendix, Citroën, Peugeot, Renault  
 P1: Peugeot 307,308.

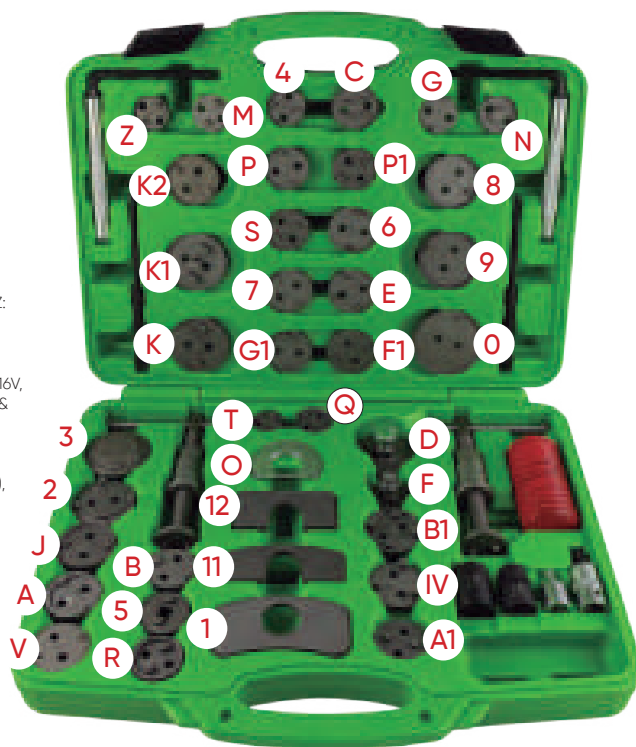



## CONJUNTO REPOSICIONADOR DETRAVÕES

51059

99,00€



- Sistema de múltiplo uso com 37 peças para repar os embolos de travões.
- Útil para a maior parte de veículos.
- Contém:
- 2x chaves hex. de 6 e 7mm.
- 2x adaptadores para os sistemas de travoes de Mercedes e Opel.
- 3x adaptadores de apoio para pinças de travões utilizáveis em espaços limitados.
- 3x adaptadores de apoio para pinças de travões utilizáveis em áreas de espaço limitada.
- 1x Fole com óleo lubrificante.

1pc: Grampo de rotação direita (com rosca à direita) 1pc: Grampo de rotação esquerda (com rosca à esquerda)  
 O: Disco 1: Disco 11: Disco para tipo S 12: Disco para BMW mini 5: Adaptador 3/8 2: Citroen XM, Xantia (F/R)  
 3: Alfa Romeo, Audi, Austin, BMW, Ford, Honda, Jaguar, Mercedes-Benz, Mitsubishi, Nissan, Rover, Toyota, VW.  
 4: Alfa Romeo 164 2.0, Ford, Mazda, Saab 9000, Subaru. 6: Nissan Primera, VW-Golf IV.  
 7: Audi 80, 90, V8 +100, Ford Sierra ABS+Scorpio ab 85, Honda Prelude Nissan Silvia 1.8 turbo, Rover 8000, Saab 9000, Subaru L+Z, VW-Golf +Passat.  
 8: GM Motors. 9: GM Motors. O: GM Motors. M: Ford. N: Saab, Honda. Z: Renault. E: Cefiro, Maxima. G: Opel.  
 K: Citroen C5, K1, K2: Citroen, Renault. A: disco de dois pinos 1-3 / 16" para Renault R21, Laguna B: Ford, Lincoln, Subaru.  
 C: Mini Austin. D: Citroen, Renault. F: Audi, BMW, Ford, Lancia, Proton, Renault, Rover, VW.  
 J: Alfa Romeo 155 1.8-2.0 164 TD(93) 164 3.0 V6(91) Audi, 80, 90, A3, A4, A6, A8 Citroen ZX 2 Ql 16V, Fiat Tipo TD 16V, Uno Turbo(85) Crama TD, Ford Sierra(ABS bak), Granada (85), (Australia & NZ) Thunderbird Turbo, Honda CRX, 1.6l-16V (8-90), Accord 1800(84-85)2.0i, Prelude 16V(88), Legend V6, Jaguar XJ40series, Lancia Dedra 2.0 Ei Tur(93), Delta 1.6Gti, Nissan, Peugeot, Renault, Seat, Subaru, Volvo V40& S40.  
 R: Ford (Australia & NZ) Telstar, Laser, Mazda 323 Gti, GTX(86-), 929(82-), RX7(81-), 626 16V(87-), 626 GT (86-), 929 V6(88-), Mitsubishi Galant GL Si, Toyota Celica, Corolla GT, MR2.  
 S: Audi 100TQi (91), BMW 740i 8cyl.(91), Lancia Delta 19 TD(95), Proton 416, Renault-most models, Renault Laguna 2.0 (94), Laguna 2.2 D(95), Safrane 2.0-2.2 TD V6, Rover 623 Si, Volkswagen Golf Gti Mk 3&4, Passat VR6, Vento GT(92).  
 H6: BMW H7: BMW Pin Ø 3.0 Pin Ø5.5 100g Grasa.

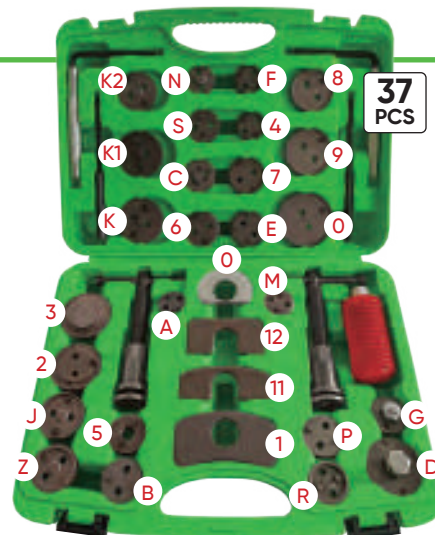

## CONJUNTO DE REPOSICIONADOR DE TRAVÕES

53978

38,90€



- Kit usado para comprimir o pistão da pinça.

O: Placa  
 1: Placa  
 0: General Motors (Ø pistões 21/2 pol.)  
 2: Citroën XM, Xantia  
 3: Alfa Romeo, Audi, Austin, BMW, Ford, Honda, Jaguar, Mercedes-Benz, Mitsubishi, Nissan, Rover, Toyota, VW  
 4: Alfa Romeo 164 2.0, Ford, Mazda, Saab 9000, Subaru  
 5: Adaptador quadrado 3/8 pol.  
 6: Nissan Primera, VW Golf IV  
 7: Audi 80; 90; V8 + 100, 1985 Ford Sierra ABS + Scorpio, Honda Prelude, Nissan Silvia 1.8 turbo, Rover 8000, Saab 9000, Subaru L + Z, VW Golf + Passat  
 8: General Motors (pistões de 17/8 pol.)  
 9: General Motors (Ø pistões 21/8 pol.)  
 IV: VAG, Renault, Volvo com freio de estacionamento eletrónico  
 A: Renault  
 E: Nissan Maxima, Cefiro  
 F: Opel  
 J: Para Fiat Tipo TD 16V, Uno Turbo (85) Crama TD, Honda CRX, Alfa Romeo 155 1.8-2.0i, 164 TD (93), 164 3.0 V6 (91); Audi 80, 90 e V8, A3, A4, A6, A8 (pinça traseira); Citroen ZX 2.0l 16v; Fiat Tipo TD 16V, Uno Turbo (85-), Crama TD; Ford Sierra (parte traseira com sistema de travagem antibloqueio ABS), Granada (85-); Ford (Austrália e Nova Zelândia) Thunderbird Turbo; Honda CRX, 1.6l-16V (88-90), Accord 1800 (84-85), 2.0i (86-), Preludi 16V (88-), LegendV6; Jaguar XJ 40 series Lancia Dedra. 2.0 Ei Tur (93), Delta 1.6 Gti. (92), o. majE 16v (92), Thema. 2000 Turbo. Kappa 2.Q-2.4LS, 2.4TD; Nissan 280 ZX (82-84), 300 ZX Turbo (84-89), Bluebird 16V (89-), Silvia 1.8 Turbo (85-88) 100 NZ 2.0 (93), Primera 2.0 GT (94), 200 SX turbo 16 V, Maxima 2.0 GX-3.0 GX (95); Peugeot 306; Peugeot 309 Gtj 16S (91), 405. Srif Q. rj, Gil (87-), 405 M.I 16v; Van Renault Master; Rover 216 Gti 16V, 820 Si 2.0 (93), 825 SD 2.5 (93); Saab 9000 CS 2.0 (93), 9000 CSE Turbo (93); Seat Toledo GT. 16V-GT 2.0 (93), Ibiza 1.8 Gti 16V (95); Subaru série L e série 2; Volkswagen Passat 2.0 e 2.2 litros (84), Golf Rallye (-89), Golf II Gti 16V (89-), Vento GT (92), Transporter T4; Volvo S40 e V40  
 K: Citroën C5  
 K1: Citroën  
 K2: Citroën  
 M: Ford  
 N: Saab, Honda



## CONJUNTO DE REPOSICIONADOR DE TRAVÕES UNIVERSAL

52906

38,00€

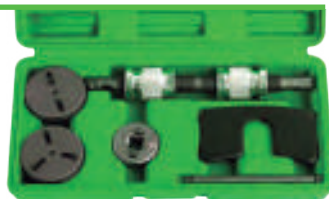

12974



12975

REF.	DESCRIÇÃO	Kg	Sub	€
12974	Repuesto 2 pins	0,15	50	21,00€
12975	Repuesto 3 pins	0,17	50	23,00€

- Alfa Romeo 164 2.0, Ford, Mazda, Saab 9000, Subaru, Nissan Primera, VW, Audi, Ford Sierra ABS + Scorpio ab 85, Honda Prelude, Nissan Silvia 1.8 turbo, Rover 8000, Saab 9000, Ford, Opel, BMW, Lancia, Proton, Renault, Rover, Peugeot 307, 308 A3- Iveco Daily, Volkswagen Passat 2.0 TDI 09, Renault Laguna.

## REPOSICIONADOR DE FREIO

14142

109,00€

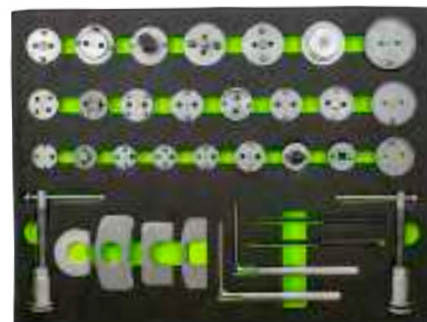

- 24x adaptadores
- 4x placas de retenção
- 2x eixos de rosca
- 2x socos
- 2x llaves hexagonais

## SANGRADOR DE TRAVÕES

52191 198,00€

9,05 - 1 15  
Kg SUB

- Pressão de trabalho: de 0 a 4 kg/cm<sup>2</sup>.
- Entrada e saída de 1/2".
- Peso: 5Kg.
- Adaptadores: 11 + 2 universais.
- Aplic.: GM, Chrysler, Nissan.

330mm 230mm 230mm



5L

## TAMPAS PARA SANGRADOR DE TRAVÕES PARA VEÍCULOS GM, CHRYSLER, GM, NISSAN

52328 99,00€

2,90 - 4 68  
Kg SUB

- 7 Adaptadores de aceite de travões: Universal n°1, n°2, n°3, n°4



## ESTOJO PARA REPARAÇÃO DE TRAVÕES

52434 125,00€

3,25 - 5 100  
Kg SUB

- Contém:
- Chave para fêmea de travão.
- 2 Alicates de mola de travão.
- Chave de fenda de impacto.
- Chave de cardan.
- Chave para desapertar.
- Ferramenta especial de travão.
- Escova de limpeza.
- Alicates de cabo de travão.
- Lima para cinta de travão.



## ALICATE PARA MOLAS DE TRAVÃO

52625 9,00€

0,35 6 48 1824  
Kg SUB

- Para remoção e instalação de molas de retorno em freios a tambor.



## CONJUNTO DE CHAVES DE CAIXA PARA PINÇA DE TRAVÃO

54135 82,00€

1,45 5 10 400  
Kg SUB

- Audi (A4, A5, S5, S8, Q5, Q7)
- Porsche (Cayenne, Macan, Cayman)
- Mercedes Benz
- Ford
- BMW
- Alfa Romeo



## SEPARADOR DE EMBOLOS DE TRAVÕES

52315 16,00€

0,88 5 20 640  
Kg SUB

- Abertura máxima 80mm.



## TESTE DE FLUÍDO DE TRAVÕES

51839 24,00€

0,05 25 100 2400  
Kg SUB

- Funciona com pilhas 1xAAA LR03.
- Com 4 níveis de qualidade de medíveis de 0% a 4%.



## APALPA FOLGAS PARA PASTILHAS DE TRAVÕES

52455 16,00€

0,26 10 20 864  
Kg SUB

COLOR	METRIC	SAE
Green	8-10-12mm	0.3150-0.4720"
Yellow	4-5-6mm	0.1575-0.2382"
Red	2-3mm	0.0787-0.1181"



## SANGRADOR DE TRAVÕES

52275 38,00€

0,79 - 4 112  
Kg SUB

0.75 L

- Temperatura de trabalho: 10 ° C a 50°C.
- Mangueira de silicone: 1m.
- Pistola da ar de entrada 1/4".
- Pres.: 6-12 bar (87 - 174 psi).
- Consumo de ar: 180l/min.







# UTILLAJE

- 178 SISTEMA DE LUBRIFICAÇÃO
- 183 SISTEMA DE INJEÇÃO
- 187 REPARADOR DE ROSCAS - CARTER
- 189 MEDIDOR DE COMPRESSÃO
- 190 AQUECEDORES
- 191 EXTRATORES
- 203 DINAMOMÉTRICAS
- 205 MULTIPLICADORES DE FORÇA  
/ EMBREAGEM
- 207 SISTEMA AACC
- 208 SISTEMA DE REFRIGERAÇÃO
- 210 CABEÇOTE / VÁLVULAS
- 211 COMPRESSORES DE MOLA
- 212 VARIADOS
- 214 ORGANIZADORES / BANDEJAS
- 215 CORTADORES DE CORRENTES  
/ ESCOVAS



# CONJUNTO DE CHAVES PARA FILTROS DE ÓLEO DE ALUMÍNIO, 19 PÇS

54068 198,00€

4,00	-	2	48
Kg	Sub	ft	



## REPOSIÇÕES DISPONÍVEI

19  
PCS

REF.	Nº DE PEÇAS	CARACTERÍSTICAS	Ø x FACES				€
15494	05101	Mazda, Mitsubishi	100,5mm x 15	5	10		12,50€
15495	0595	Nissan, Toyota	94,5mm x 15	5	10		12,50€
15496	0592	Nissan, Subaru	92mm x 15	5	10		11,50€
15497	0579	Toyota, Honda, Mitsubishi, Subaru, Mazda, Isuzu	79mm x 15	5	10		11,00€
15498	915	Volvo	87mm x 16	5	10		11,50€
15499	901L	Lexus	79,5mm x 14	5	10		11,00€
15500	901T	Toyota	70mm x 14	5	10		10,00€
15501	901-1	Toyota	63-64mm x 14	5	10		10,00€
15502	902	Ford, Mazda	66,5mm x 14	5	10		10,00€
15503	1284	Dodge Sprinter (2007-), Mercedes Benz E320 (2007-), Jeep Cherokee 3.0L V6 Common Rail (2007-)	84mm x 14	5	10		11,00€
15504	903B	Mercedes Benz	74mm x 14	5	10		10,00€
15505	24mm	BMW 5, BMW 7, BMW X5 V8 (N62) (2004-), Saturn (2008), Astra 1.8L ECOTEC, Chrysler 3.6L V6 (2011-), 200, 300, T/C Dodge Jeep	24mm x 14	5	10		4,00€
15506	27mm	Mercedes Benz Classe A	27mm x 6	5	10		4,00€
15507	30mm	Audi A2, Vw Polo, Lupo 1.4L/1.6L	30mm x 6	5	10		4,50€
15508	32,5 mm	Opel Astra G, Corsa B, Zafira, Audi, VW 1-36 mm, Opel Omega, Vectra B, Zafira (98-), BMW M43/60	32,5mm x 6	5	10		4,50€
15509	36mm	Opel Omega, Vectra B, Zafira (98-), BMW M43/60, Mercedes Benz Vito CDI, C, E, VW Lupo 1.2 TDI, MAN	36mm x 6	5	10		5,00€
15510	38mm	Opel Vectra 2.0D	38mm x 6	5	10		5,00€
15511	917	Universal	55-90mm	5	10		8,00€

# JOGO DE EXTRATORES PARA FILTROS ÓLEO

51332 98,00€

4,20	-	5	60
Kg	Sub	ft	



## REPOSIÇÕES DISPONÍVEI







23  
PCS

REF.	Nº DE PEÇAS	CARACTERÍSTICAS	Ø x FACES				€
11374	901	Toyota, Nissan, Fiat Daihatsu	65mm x 14	0,10	5	20	5,50€
11375	902	Toyota, Daihatsu	67mm x 14	0,08	5	20	6,50€
11376	903	VW, Mercedes, BMW, Opel, Audi	74mm x 14	0,09	5	20	5,50€
11377	903-1	GM/AC, Wix, Ford, Isuzu	75mm x 15	0,09	5	20	5,50€
11378	903-2	VW, Audi, Seat, BMW, Renault	74mm x 8	0,09	5	20	6,50€
11379	903-3	Audi, Rover, Chrysler	74mm x 15	0,11	5	20	6,00€
11380	903-4	Toyota, Lexus	73mm x 14	0,11	5	20	6,50€
11381	903-6	Schlepper, Baumashinen	75mm x 12	0,10	-	50	6,50€
11382	918	Rover, Chrysler, Audi	74mm x 15	0,11	5	20	6,00€
11383	904	Nissan, Ford	79mm x 15	0,10	5	20	6,00€
11384	905	GM, Chrysler	73mm x 15	0,12	5	20	6,00€
11385	905-1	BMW, Mercedes, Opel, Audi, VW	74mm x 14	0,10	5	20	5,50€
11386	906	Baumaschinen, Schlepper	84mm x 18	0,10	5	20	6,00€
11387	907	Mitsubishi, Toyota	89mm x 15	0,13	5	20	6,00€
11388	908	Nissan, Toyota	91mm x 15	0,14	5	20	6,00€
11389	915	Honda Accord, Mitsubishi, Isuzu	90mm x 15	0,16	5	20	6,00€
11390	910	Toyota, Alfa Romeo, Ford	95mm x 15	0,12	5	20	6,00€
11391	911	Fiat, Renault, Citroën	80mm x 12	0,09	5	20	6,50€
11392	911-1	Subaru, Toyota, Honda, Nissan	80mm x 15	0,09	5	20	6,00€
11393	914	Mazda, Toyota	101mm x 15	0,18	5	20	6,00€
11394	909	Isuzu, Nissan	92mm x 15	0,14	5	20	6,00€

REF.	CARACTERÍSTICAS					€
14992	Chave de 12 vias	0,10	-	-	-	8,50€
10955	Catraca 1/2"	0,14	-	1	50	11,00€



# CHAVE EXTRAÇÃO PARA FILTROS DE ÓLEO

<b>52311</b> 19,00€ 0,13 6 72 1728 Kg SUB ITT  GRUPO VAG 42mm	<b>52312</b> 9,00€ 0,10 10 100 1800 Kg SUB ITT  VW, OPEL, MERCEDES, BMW, AUDI 74mm x 14C	<b>52313</b> 8,00€ 0,20 6 68 1008 Kg SUB ITT  VOLVO 540, 560, 570, 580 86mm x 16C
<b>52314</b> 26,60€ 0,20 5 50 600 Kg SUB ITT Em caixa.  BMW VOLVO 87mm x 16C	<b>52809</b> 8,50€ 0,15 10 100 1000 Kg SUB ITT  3/8" TOYOTA 64,5mm x 14C	<b>53441</b> 9,80€ 0,20 5 20 800 Kg SUB ITT  76mm x 14C

## EXTRATOR PARA FILTRO ÓLEO FORD, CITROËN, PEUGEOT 2.0, 2.2 HDI, TDCI

**53008** 15,50€

0,60 5 30 1500  
Kg SUB ITT



250mm



## EXTRATOR DE FILTROS DE CAMINHÃO

**52518** 115,00€

1,40 6 12 480  
Kg SUB ITT

95-165mm



## EXTRATOR PARA FILTRO DE ÓLEO

**52615** 112,00€

3,05 - 5 70  
Kg SUB ITT

- Chave de doble sentido ajustável.  
- Rango de aplicação: 60-80mm.

Audi, BMW, Mercedes, Opel, Renault, Volvo, Kia, Hyundai, Ford, VW, Skoda, Citroën, Mini

9 PCS

1/2" x1 UNIVERSAL 63-83mm

3/8" x8

- 27mm: Mercedes-Benz, Smart.
- 32mm: GM, Opel/Vauxhall, Mercedes-Benz.
- 36mm: Mercedes Diesel, BMW, Mini, Ford.
- 15 - 88,8mm: Hunday, Kia.
- 14 - 64,5mm: Toyota (Allion, Auris, Corolla, Prius, Voxy, etc.).
- 64,5mm: Toyota, Lexus (6 Zyl.).
- 74,2mm: Audi, BMW, Ford, Toyota, Volkswagen, Porsche, Mercedes-Benz.
- 16 - 86,6mm: BMW 3+5+X, Volvo.



## EXTRATOR FILTRO DE ÓLEO DE PATILHA PLANA / REDONDA

- Pode usarse com chave de 1/2" ou 3/8".

<b>51352</b> 9,80€ 0,40 5 40 960 Kg SUB ITT  57-118mm	<b>51934</b> 11,50€ 0,40 10 40 1200 Kg SUB ITT  57-118mm	<b>51353</b> 11,50€ 0,65 5 40 960 Kg SUB ITT  72-136mm	<b>51923</b> 12,50€ 0,56 10 40 960 Kg SUB ITT  72-136mm
--	---	--	--

- Extrae todos os filtros de óleo 2-1/4" a 5" de diâmetro.

- Extrae todos os filtros de óleo 2-1/2" a 4" de diâmetro.

- Extrae todos os filtros de óleo 2-1/2" a 4" de diâmetro.

- Extrae todos os filtros de óleo 2-1/2" a 4" de diâmetro.

# CONJUNTO DE 5 VARAS PARA VERIFICAR O ÓLEO BENZ/AUDI

**53206** 38,20€

**5**  
PCS

0,55	5	20	140
Kg	Sub	ff	ff

- Para verificar o fluido de transmissão de óleo nos motores audi 100:

Na ponta (os primeiros 11mm) é a leitura do fluido a frio 20 0 c.

A segunda leitura é no mínimo a 800 c.

A terceira leitura é a 800 c. no máximo.

- Mantenha o veículo a nível para verificar o atf.

- Vareta medidora para verificar o nível do óleo no motor. compatível com uma grande seleção de motores de 1988 a 2005 na gama mercedes.



- AUDI 100 motores.

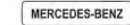

- Ano de fabrico: 1988-1997.

- Códigos do motor: 103,104,111,119,120,137,604,605,606,611,612,613,628,642,647,648.

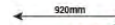

- Código de transmissão: 716.5,722.7,722.8.



- Ano de fabrico: 1996-2005.

- Códigos do motor: 103,104,111,112,113,119,120,137,271,272,604,605,606,611,612,613,628,642,646,647,648.

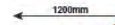

- Código de transmissão: 722.6.

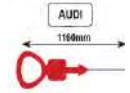

VARETA PARA VERIFICAÇÃO DE ÓLEO - AUDI

**13856** 7,80€

0,04	5	100
Kg	Sub	ff

## PINÇA EXTRATORA DE FILTROS DE ÓLEO

**51354** 13,20€

0,43	5	40	600
Kg	Sub	ff	ff

80-120mm



## CHAVE DE FILTRO DE ÓLEO PARA VAG DSG 1/2" 24 MM

**53670** 29,50€

0,25	10	40	1680
Kg	Sub	ff	ff

**1/2"**

- Conjunto de ferramentas para reparar e recondicionar os parafusos das rodas, bem como ancorá-lo à rosca fêmea do veículo; útil em rosas parcialmente danificadas.



## EXTRATOR DE FILTROS DE CINTA

**52269** 7,00€

0,20	10	50	1200
Kg	Sub	ff	ff

80-120mm



SUBSTITUIÇÃO 360mm

**11106** 3,00€

0,02	10	50
Kg	Sub	ff

## EXTRATOR DE FILTROS AJUSTÁVEL

**52677** 17,00€

0,32	10	40	480
Kg	Sub	ff	ff

∅ 65-105mm

**52678** 18,00€

0,33	10	40	400
Kg	Sub	ff	ff

∅ 110-155mm



REF.	SUBSTITUIÇÃO	PARA	Kg	Sub	ff	ff	€
11936	383mm	52677	0,03	10	100	100	4,00€
11937	540mm	52678	0,04	10	100	100	5,00€

## EXTRATOR DE FILTROS DE CORRENTE

**52417** 28,00€

0,90	5	25	800
Kg	Sub	ff	ff

∅ 160mm 300mm

CADEIA DE ALTA RESISTENCIA

SUPERFÍCIE DENTADA PARA EXCELENTE ADERÊNCIA



## EXTRATOR FILTROS DE CORRENTE

**52416** 14,00€

0,37	5	50	900
Kg	Sub	ff	ff

∅ 150mm 20mm 540mm

CORREIA DE POLÍMERO (ALTA RESISTÊNCIA)

SUPERFÍCIE DENTADA PARA EXCELENTE ADERÊNCIA





## EXTRATOR DE FILTROS DE CORRENTE

**52607** 49,00€

0.85	6	24	576
Kg	Sub	Up	Tray

Ø 60 - 140mm



**52608** 44,00€

0.95	6	24	360
Kg	Sub	Up	Tray

Ø 60 - 195mm



DOBLE CADEIA ARTICULADO

## TAMPAS DE DRENAGEM DE ÓLEO

**53741** 14,00€

0.05	10	100	4000
Kg	Sub	Up	Tray

FORD/PSA



**13969** 19,00€

0.01	10	100	-
Kg	Sub	Up	Tray

VAG



**53537** 14,50€

0.05	10	100	4000
Kg	Sub	Up	Tray

BMW



**53538** 14,50€

0.10	10	100	4000
Kg	Sub	Up	Tray

FORD



5 PCS

## JOGO DE CHAVES PARA BUJÃO DE CARTER

**53735** 44,00€

1.70	-	5	375
Kg	Sub	Up	Tray

3/8" 23 PCS

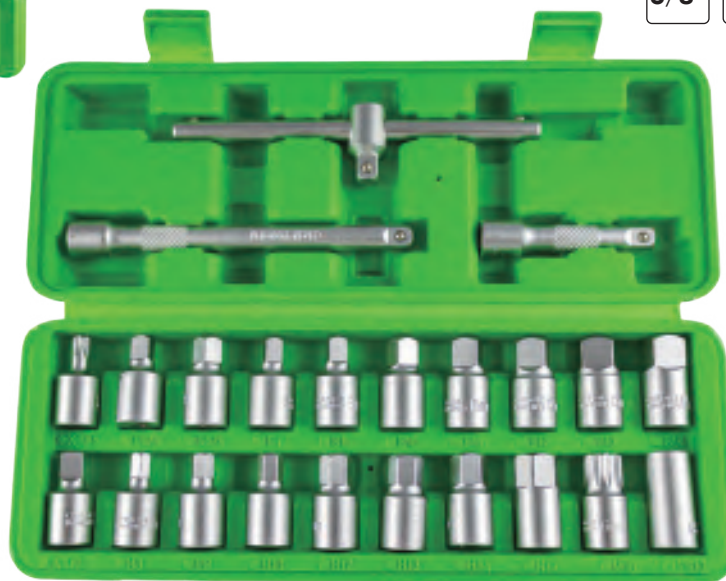

### CONTÉM

	x2	5/16", 3/8"
	x7	7, 8, 10, 11, 12, 13, 14mm
	x1	10mm
	x1	10mm
	x7	8, 9, 10, 12, 13, 14, 17mm
	x1	T45
	x1	M16
	x1	200mm
	x2	75, 150mm

## MÓDULO DE CHAVES PARA BUJÃO DE CARTER

**15084** 68,00€

1.70	-	-	-
Kg	Sub	Up	Tray

MÓDULO COM ACABAMENTO EM FIBRA DE CARBONO

240x135x32mm

22 PCS

### CONTÉM

	x2	5/16", 3/8"
	x7	7, 8, 10, 11, 12, 13, 14mm
	x1	10mm
	x1	10mm
	x7	8, 9, 10, 12, 13, 14, 17mm
	x1	T45
	x1	M16
	x1	200mm
	x1	150mm

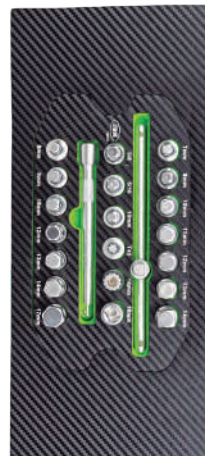

## CHAVE PARA BUJÕES DE CARTER DE PLÁSTICO (VAG)

53472 12,00€

0.10	10	100	1200
Kg	sub	ff	ff

OEM: T10549



- Função: Para a extração de bujões de cárter de plástico.

- Aplicações:

Audi: A1, A3, A4, A5, A6, A7, Q3, Q5, Q7, TT, TTS.

Seat: Alhambra, Leon, Toledo.

Skoda: Octavia, Rapid, Superb, Yeti.

VW: Beetle, Caddy, CC, Golf, Jetta, Passat, Polo,

Scirocco, Sharan, Tiguan, Touran.

## CHAVE QUADRADA PARA BUJÕES

52617 7,00€

0.23	6	36	1512
Kg	sub	ff	ff

8 - 10mm

- Para Citroën, Renault, Peugeot.



## CONJUNTO EXTRATOR DE BUJÕES DE CÁRTER DE PLÁSTICO

53473 36,00€

0.40	10	50	800
Kg	sub	ff	ff

5 PCS

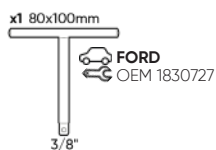

FORD, VAG, PEUGEOT, CITROËN, BMW

## KIT DE REPARAÇÃO DE BUJÕES DE CARTER

51337 50,00€

1.55	-	10	180
Kg	sub	ff	ff



- Bujões de SKS3.  
- Machos de 1015.  
- Anilhas de Cobre.

- Contém:  
M13x1,5P  
M15x1,5P  
M17x1,5P  
M20x1,5P

- Macho: 1 x medida.  
- Bujões: 5 x medida.  
- Anilhas: 10 x medida.

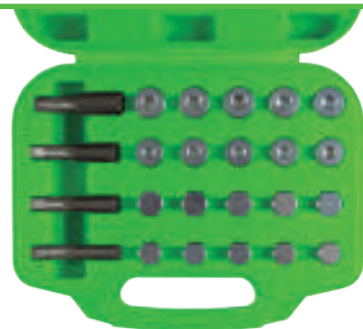

### REPOSIÇÕES DISPONÍVEL

5 nozes + 5 arruelas\*

\*Entregado em bolsas de 5 unidades.  
5 nozes + 5 arruelas

REF.	CARACTERÍSTICAS	Kg	5	50	100	€
51403	M13 x 1,5P	0,13	5	50	100	17,50€
51400	M15 x 1,5P	0,17	5	50	100	17,00€
51401	M17 x 1,5P	0,15	5	50	100	22,00€
51402	M20 x 1,5P	0,10	5	25	50	20,50€

REF.	CARACTERÍSTICAS	Kg	5	50	100	€
14930	M13 x 1,5P	0,05	10	100	9,50€	
14931	M15 x 1,5P	0,05	50	100	8,00€	
14932	M17 x 1,5P	0,07	5	100	9,50€	
14933	M20 x 1,5P	0,10	5	100	9,50€	

## KIT REPARADOR DE ROSCAS DE TAMPÃO CÁRTER

53235 10,40€

0.25	10	40	-
Kg	sub	ff	ff

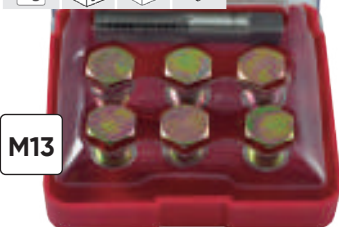

M13

53236 11,50€

0.35	10	40	-
Kg	sub	ff	ff



M15

53237 12,90€

0.35	10	40	-
Kg	sub	ff	ff



M17

53238 18,40€

0.40	10	40	-
Kg	sub	ff	ff



M20



## EXTRATOR PNEUMÁTICO PARA INJETORES

54186

320,00€

Bosch, Delphi, Denso, Siemens

S

6-8 bar

20-30 Nm

6,79 - 2 80  
Kg SUB

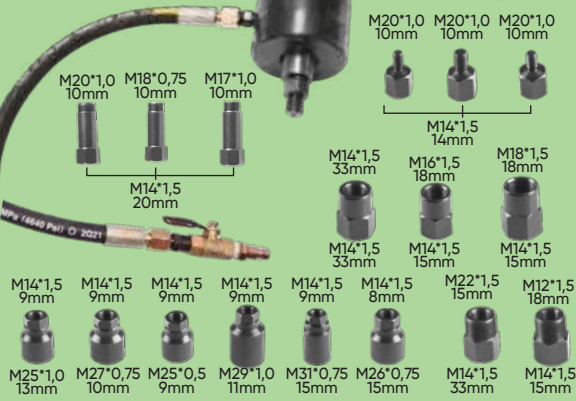

## EXTRATOR DE INJETORES HIDRÁULICO

54245

580,00€

Bosch, Delphi, Denso, Siemens

1795 - 1 100  
Kg SUB

Este conjunto de ferramentas foi concebido para remover injetores apertados com pouco esforço, graças ao seu sistema hidráulico que lhe permite exercer uma força que chega às 10 toneladas.

Conexão do cilindro hidráulico: 3/8 de polegada NPT  
Força do cilindro hidráulico: 10 toneladas

Adequado para a extração de injetores de gasóleo, especificamente:

Tem de ser utilizado com uma bomba manual hidráulica.



M17 x 1.0	Bosch	M20 x 1.0	Denso
M14 x 1.5	Delphi	M25 x 1.0 / M27 x 1.0	Siemens
M16 x 1.0	Toyota		

## BOMBA HIDRÁULICA MANUAL

54257

318,00€

PARA REF. 54245

11,40 - 1 32  
Kg SUB

1,8m

1000 PSI

Número de etapas: 2

Pressão de funcionamento:

Etapa 1: 0-20 kg/cm<sup>3</sup>

Etapa 2: 20-700 kg/cm<sup>3</sup>

Pressão de trabalho máxima:

1000 PSI

Óleo utilizável: 700cc



Fluxo:

Etapa 1: 13cc

Etapa 2: 2.3cc

Comprimento da mangueira: 1,8m

Conexão: 3/8 de polegada NPT

Peso: 10,32kg

## EXTRATOR DE INJETORES DIESEL PARA CITROËN, PEUGEOT

53069

98,00€

CITROËN PEUGEOT

3,44 - 5 150  
Kg SUB

- 1x ponte rolante.
- 3x suportes de ponte.
- 2x fuso extrator - Ø17mm, Ø25mm
- 1x porca cilíndrica para fuso.
- 2x mangas de injetores de 25 mm e 29 mm.
- 1x chave hexagonal de segurança de 21 mm.



## JOGO EXTRAÇÃO DE INJETORES

51494

107,00€

3,60 - 4 96  
Kg SUB

- Com martelo deslizante para motores CDI e motores Mercedes CDI Om 611, 612, 613 etc. para extrair os INJETORES entupidos e common-rail sem desmontar a culaça.
- A construção robusta permite uma melhor extração dos INJETORES mais bloqueados.

- Material: aço S45C.
- Longitude total: 350mmL.

- Contém: Martelo: 1.75Kgs. Adaptador: M17 x 1,0 Adaptador: M27 x 1,0



## CHAVE DUPLA ABERTA PARA INJETORES

52821

28,80€

0,24 - 6 96 -  
Kg SUB



17mm



# JOGO DE EXTRAÇÃO DE INJETORES

**52858** 298,00€

21,20	-	1	40
Kg	Sub	ff	

- Para remover os INJETORES diesel.  
- Adequado para a maioria dos INJETORES diesel, muitos adaptadores incluídos.

- Componentes:

3 martelos diferentes:  
1,6 kg - 160 mm de comprimento.  
2,7 kg - 460 mm de comprimento.  
5,1kg - 600 mm de comprimento.

Puxando a aderência com a abertura da forquilha:  
13,7x18mm, comprimento 105mm.  
12,7x19mm, comprimento 130mm.

1/2 "vasos de fenda 6pt, 100 mm de comprimento.  
Tamanhos: 25, 27, 28, 29, 30.  
Eixo EXTRATOR Injector M17x1,0.

Adaptador com rosca externa:  
M27x1,0x1,0 e M25.

Adaptador com rosca interna:  
M27x1,0 parafuso.



# ESTOJO DE ANILHAS DE COBRE PARA INJETORES 551 PCS

**53464** 153,00€

1,85	-	5	90
Kg	Sub	ff	



**551**  
PCS

pg.328

# EXTRATOR DE BOMBA DE INJEÇÃO DIESEL BMW

**53501** 24,00€

0,55	10	20	1120
Kg	Sub	ff	

- Segura as engrenagens durante a montagem da bomba de injeção.

- BMW: M47 / M47T2 / M47TU / M57 / M57TU.  
- SERIES: E46 (318D-320D) (1988 - 2005) and E60, E61 (318TD-320TD-525D-530D-530-535) (2000 - 2006).  
- OEM1 13 5 191 | 13 5 192 | 13 5 190 BMW.



# EXTRATOR DE INJETORES PARA MERCEDES

**52629** 99,00€

1,22	5	10	440
Kg	Sub	ff	

MERCEDES



M16X1.5

# EXTRATOR DE TUBO DE INJEÇÃO DIESEL

**53009** 42,00€

0,50	4	20	560
Kg	Sub	ff	



14, 17, 19mm



- EXTRATOR de INJETORES para Mercedes C/E/S CLASS, VITO.  
- Com conexão eléctrica.  
- Este conjunto foi especialmente desenhado para a eliminação dos INJETORES.

# EXTRACTOR DE ANILHAS DE INJETORES

**53522** 24,00€

Ø 4,5 - 15mm

0,80	5	20	480
Kg	Sub	ff	





# MEDIDOR E COMPROVADOR DE SISTEMA DE INJEÇÃO

51493

68,00€

Adequado para uso em  
BOSCH, SIEMENS, DENSO e  
DELPHI

1.85	-	5	80
Kg	sub	ff	ff

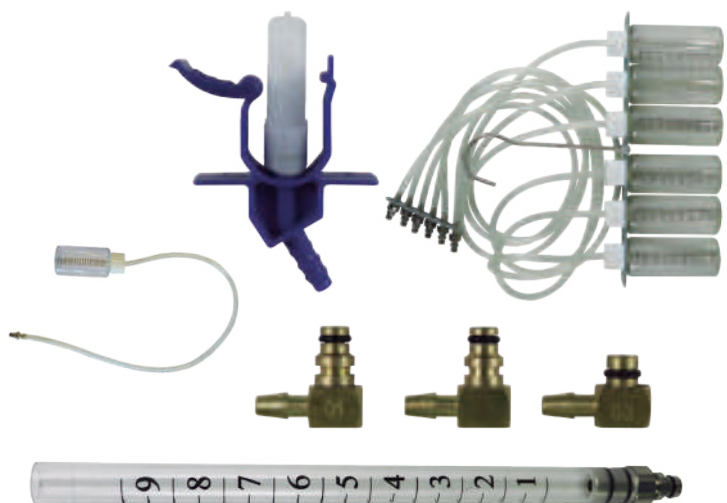

POTE + TAMPA + MANGUEIRA  
PARA 51493

12901

5,20€

0.03

10

60

Kg

sub

ff

ff

- A finalidade deste kit é medir com rapidez e eficácia a quantidade de combustível que cada injetor retorna ao depósito, de modo que você saberá se algum injetor está estragado.

- Contém:  
Suporte para pendurar os 6 frascos para a medição do combustível.  
6 tubos de medição (para crack única condição).  
Tubos brancos.  
Caixa de armazenamento.

## KIT DE CHAVES DE INJETORES

52813

79,00€

2.23	-	5	180
Kg	sub	ff	ff

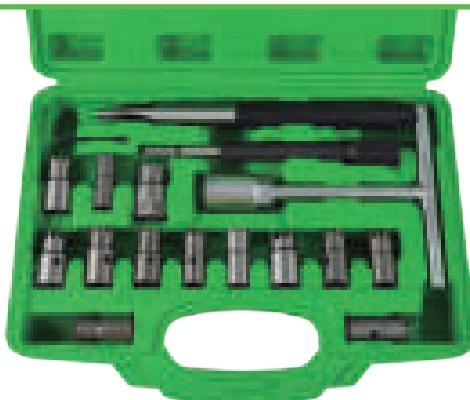

17  
PCS

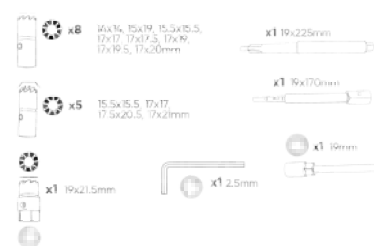

- Jogo de 17 rectificadores para limpar as sedes dos INJETORES.

## KIT DE CHAVES DE INJETORES

52273

44,00€

1.40	-	5	180
Kg	sub	ff	ff



8  
PCS



- Jogo de 7 rectificadores para limpar as sedes dos INJETORES, quando nos motores diesel se reacondicionam ou substituem os INJETORES

## KIT DE LIMPEZA DE ASSENTOS DE INJETORES

53650 47,00€

0,90	-	10	140
Kg	Sub	ff	ff

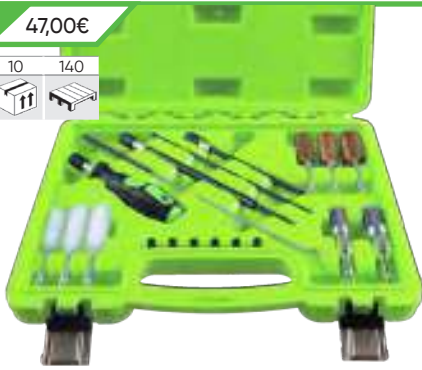

- Kit com três escovas de aço com revestimento de latão para limpar os depósitos de carbono restantes das paredes laterais do ASSENTO INJETOR, bem como duas escovas de nylon de silicone para limpar a base do ASSENTO.  
- As escovas de limpeza podem ser rapidamente conectadas à extensão flexível fornecida.  
- Este kit também contém seis tampões de vedação e uma haste de inserção para impedir que depósitos de carbono entrem acidentalmente na câmara de combustão durante o processo, além de uma escova de aço de pequeno calibre para limpar o fundo do ASSENTO.

- Contém:  
3 escovas de latão.  
2 escovas de silicone-nylon.  
1 extensor.  
6 tampões de fechamento para vedação da câmara de combustão.  
1 haste para inserção dos bujões de fechamento.  
1 escova de aço para limpeza da cabeça do cilindro.

CONJUNTO DE 3 ESCOVAS DE LIMPEZA DE LATÃO (REF.53650)

14348 0,05 50  
12,50€ Kg ff

CONJUNTO DE 2 ESCOVAS DE LIMPEZA DE SILICONE (REF.53650)

14349 0,07 100  
20,50€ Kg ff

## SET DE CHAVES PARA BOMBA INJETORA

53330 38,00€

0,75	-	20	144
Kg	Sub	ff	ff

- Bomba de injeção BOSCH.  
- TDI.  
- Common Rail.



Cr-V 1/2" 1/4" 5 PCS

## BOMBA INJECTOR DIESEL

52801 26,00€

0,10	5	50	600
Kg	Sub	ff	ff

- Durante a substituição da bomba de injeção, filtros ou outras partes, impede e retracção do combustível para o depósito.  
- Após a montagem de peças para substituir bomba permite bombear combustível para linha de injeção.



## KIT PARA O SISTEMA DE INJEÇÃO - LAMBDA

51491 154,00€

3,99	-	5	150
Kg	Sub	ff	ff

- 17x78mm (12PT): Renault, Audi, Seat, Mazda.  
- 19x78mm (12PT): VW, Polo, Audi, Seat, Mazda.  
- 20x78mm (6PT): Deschis Japon.  
- 27x78mm (6PT): Deschis Japon.  
- 21x90mm (12PT): Seat, Audi, VW, Skoda, Alfa Romeo, Mitsubishi.  
- 22x78mm (12PT): Seat, Audi, VW, Skoda, Opel.  
- 22x110mm (12PT): Mercedes, Citroen, Peugeot, Ford, Nissan, Mazda, Mitsubishi, Seat, Audi, VW, etc.



14 PCS

## CHAVE PARA SONDA LAMBDA

52822 32,00€

22mm

0,41	5	20	-
Kg	Sub	ff	ff

- Chave hexagonal com janela, permite a extracção de sondas lambda localizadas em lugares de difícil acesso.



CABEÇA ARTICULADA

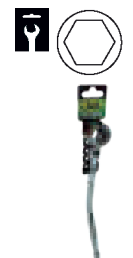



# FERRAMENTA DE INSTALAÇÃO E REMOÇÃO DE INJETORES DE COMBUSTÍVEL BMW MERCEDES BENZ

**54220** 197,00€

4,40	-	2	240
Kg	Sub	ff	tr

## MARCAS

**BMW:**  
135is (2008-), 335 (2007-), 335xi (2007-), 535i (2008-), 535xi (2008-), 550i GT (2010-), 750Li (2009-), 750i (2009-), X3 3.0i (2007-), X5 (2011-), X5 3.0i (2008-), X6 (2008-)  
**MERCEDES-BENZ:**  
C-class (2007-), CLK / SLK (2007-), E-class (2007-), A / CLA / GLA 45 AMG (2013-), CL / CLS 63 AMG (2010-), E / G / GL 63 AMG (2011-), GLE 63 AMG (2015-) / SL 63 AMG (2010-), SLK 55 AMG (2012-)

## FERRAMENTAS OEM

BMW: 130180(1), 130195(2), 130270(3), 130320(4), 2249115(5)  
Mercedes-Benz: 271589023300(6), 278589003300(7)

## CÓDIGOS DE MOTOR

BMW : N14 / N18 / N20 / N47 / N54 / N57 / N55 / N63  
Mercedes-Benz : M133 / M152 / M157 / M270 / M271 / M274 / M276 / M278



pg.183

## KIT DE REPARAÇÃO DE ROSCAS INTERNAS E EXTERNAS

**54003** 104,00€

1,60	-	10	270
Kg	Sub	ff	tr

Tamanhos da rosca:

- M14x1,5
- M16x1,5
- M18x1,5
- M20x1,5
- M22x1,5
- M24x1,5
- M27x2,0
- M28x1,5



**9**  
PCS

CrMo



## KIT 7 PEÇAS PARA SISTEMA DE INJEÇÃO LAMBDA

**51119** 62,00€

2,09	5	10	240
Kg	Sub	ff	tr

1/2"

3/8"



- Contém chaves de:  
1/2" de 29x9 a 90mm de comprimento.  
1/2" de 7/8" a 50mm de comprimento.  
1/2" de 27x12 a 78mm de comprimento.  
3/8" de 7/8" x 6 a 90mm de comprimento.  
3/8" de 7/8" x 6 a 80mm de comprimento.  
3/8" de 7/8" a 30mm de comprimento.  
3/8" de 1" e 1-1/16" a 74mm de comprimento.

## KIT REPARAÇÃO ROSCAS HELICÓIDAIS

**51896** 82,00€

2,10	-	5	300
Kg	Sub	ff	tr

**115**  
PCS



REF.	CARACTERÍSTICAS	Kg	PCS	€ / x5
52016	M5x0,8	0,01	10	2,10€
52017	M6x1,0	0,01	10	2,40€
52018	M8x1,25	0,05	10	2,60€
52019	M10x1,50	0,01	10	3,20€
52021	M12x1,75	0,02	10	3,40€

REF.	CARACTERÍSTICAS	Kg	PCS	€ / x5
52022	M14x2,0	0,01	10	4,50€
52023	M16x2,0	0,01	10	6,60€
52024	M18x2,5	0,05	10	10,60€
52025	M20x2,5	0,01	10	13,00€



- Contém por medida:  
Broca.  
Macho de rosca.  
Chave helicoidal.  
Punção de ruptura.  
Conjunto helicóide aço Inox.

- Conteúdo:  
25 x M5x0,8  
25 x M6x1  
25 x M8x1,25  
25 x M10x1,5  
10 x M12x1,75

**51897** 122,00€

2,21	-	5	378
Kg	Sub	ff	tr

**39**  
PCS



- Contém por medida:  
Broca.  
Macho de rosca.  
Chave helicoidal.  
Punção de ruptura.  
Conjunto helicóide aço Inox.

- Conteúdo:  
9 x M12x1,75  
9 x M14x2  
9 x M16x2,0

## KIT REPARAÇÃO ROSCAS HELICÓIDAIS

**53041** 37,60€

0,54	-	10	1000
Kg	Sub	ff	tr

- ESPECIAL VELA DE IGNIÇÃO.



M14x1,25



**51898** 139,00€

1,81	-	4	252
Kg	Sub	ff	tr

M18x2,5

**51899** 137,00€

2,12	-	4	252
Kg	Sub	ff	tr

M20x2,5



- Contém por medida:  
Broca.  
Macho de rosca.  
Chave helicoidal.  
Punção de ruptura.  
Conjunto helicóides aço Inox.

## CONJUNTO FERR. CORTE 60 P. MACHOS E CAÇONETES. MÉTRICO E PULGADA

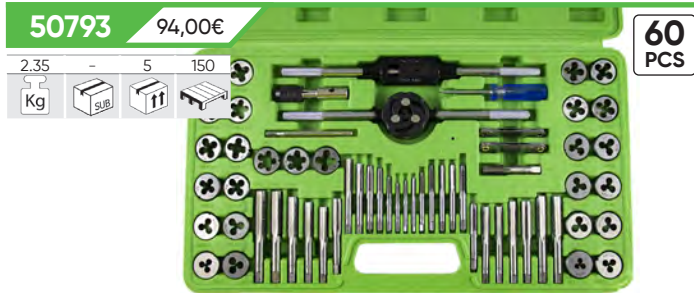

50793 94,00€

2,35 - 5 150

Kg SUB fff

1 NPT macho (pol.): 1/8-27.  
1 NPT caçonete (pol.): 1/8-27.  
1 Porta Macho misto tip: M3 ~ M12 e 3/16 "a 1/2".  
1 Porta Macho misto tip: M3 ~ M6 ~ 6-32 e 4-40.  
1 Porta caçonetes misto: 25mm Ø.  
1 chave de fenda.  
1 jogo de galgas em polegadas para rosca.  
1 jogo de galgas métricas para rosca.  
10 Machos (métricos): M3x0.5, M4x0.7, M5x0.8, M6x1.0, M7x1.0, M8x1.25, M9x1.25, M10x1.0, M10x1.5, M12x1.75.

60 PCS

10 Machos UNC (polegadas): 4-40, 10-24, 6-32, 8-32, 12-24, 1/4-20, 5/16-18, 3/8-16, 7/16-14, 1/2-13.  
6 caçonetes UNF (polegadas): 10-32, 1/4-28, 5/16-24, 3/8-24, 7/16-20, 1/2-20.  
10 Caçonetes (métricas): M3x0.5, M4x0.7, M5x0.8, M6x1.0, M7x1.0, M8x1.25, M9x1.25, M10x1.0, M10x1.5, M12x1.75.  
10 Caçonetes UNC (polegadas): 4-40, 10-24, 6-32, 8-32, 12-24, 1/4-20, 5/16-18, 3/8-16, 7/16-14, 1/2-13.  
6 caçonetes UNF (polegadas): 10-32, 1/4-28, 5/16-24, 3/8-24, 7/16-20, 1/2-20.

## CONJUNTO FERR CORTE 58P. MACHOS E CAÇONETES RECOBERTAS DE TITÂNIO



50792 105,00€

2,59 - 6 216

Kg SUB fff

1 Macho e 1 caçonete tipo NPT: 1/8-27.  
1 Porta Machos tipo: M3 ~ M6.  
1 Porta caçonete: 25mm O / D.  
1 chave de fenda.  
1 jogo de galgas para rosca.

58 PCS

17 Machos: 2x0.4, 3x0.6, 3x0.5, 3.5x0.6, 4x0.75, 4x0.7, 5x0.8, 6x0.75, 6x1.0, 7x0.75, 7x1, 8x1.0, 8x1.25, 10x1.25, 10x1.5, 12x1.25, 12x1.75.  
17 Caçonetes: 2x0.4, 3x0.6, 3x0.5, 3.5x0.6, 4x0.75, 4x0.7, 5x0.8, 6x0.75, 6x1.0, 7x0.75, 7x1, 8x1.0, 8x1.25, 10x1.25, 10x1.5, 12x1.25, 12x1.75.

## KIT UNIVERSAL DE TESTE DE PRESSÃO DO SISTEMA DE REFRIGERAÇÃO (5 PÇS)



54139 147,00€

3,15 - 5 60

Kg SUB fff

5 PCS

- Durante a substituição da bomba de injeção, filtros ou outras partes, impede e retracção do co bombustível para o depósito.
- Após a montagem de peças para substituir bomba permite bombear combustível para linha de injeção.

## PROVADOR DE PRESSÃO E VÁCUO



53426 39,80€

0,90 4 16 160

Kg SUB fff

## MEDIDOR DE PRESSÃO DE ÓLEO

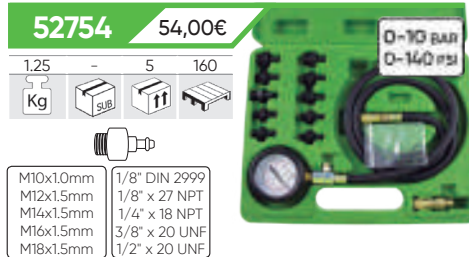

52754 54,00€

1,25 - 5 160

Kg SUB fff

M10x1.0mm  
M12x1.5mm  
M14x1.5mm  
M16x1.5mm  
M18x1.5mm

1/8" DIN 2999  
1/8" x 27 NPT  
1/4" x 18 NPT  
3/8" x 20 UNF  
1/2" x 20 UNE

- Útil para a verificação da pressão de óleo e diagnosticar problemas no sistema.

## COMPROVADOR DE PRESSÃO DO TURBO



53489 68,00€

0,70 5 10 260

Kg SUB fff

## MEDIDOR DE COMPRESSÃO DIESEL PARA CAMIÓN

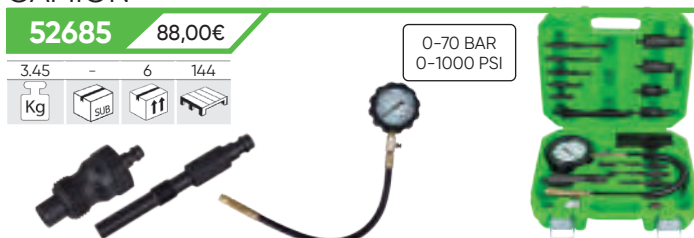

52685 88,00€

3,45 - 6 144

Kg SUB fff

0-70 BAR  
0-1000 PSI

- Kit completo para medir a compressão de veículos diesel.  
- Grande variedade de adaptadores para medir na maioria de veículos do mercado.  
- Sistema de enganche rápido para

trabalhos em sitios de difícil acesso.  
- Adaptador em ângulo e adaptador de roscas de M18 e M24.  
- Dispõe de válvula de descarga e de sistema de retenção da leitura.

## MEDIDOR DE COMPRESSÃO GASOLINA



52488 28,00€

0,65 5 20 300

Kg SUB fff

0-300 PSI  
0-21 Kg/cm<sup>2</sup>

- Relógio regulado de dupla leitura (0-300psi e 0-2,000kpa) com válvula de descompressão.  
- O seu sistema de enganche rápido permite uma medição rápida e exacta em sitios de difícil acesso; o adaptador cónico permite o uso na maioria de veículos do mercado.



## JOGO DE ALICATES PARA DESCONEXÃO DO TUBO DE COMBUSTÍVEL

53445 17,10€

0,35 12 48 576  
Kg SUB



5/16"  
8mm Ø



3/8"  
10mm Ø



APLICAÇÃO ESPECIAL



## KIT DE TESTE DE PRESSÃO GASOLINA

53997 48,00€

1,40 - 5 150  
Kg SUB

- Para detectar problemas no sistema de combustível.
- O dispositivo é compatível com os sistemas de injeção Schrader.



1 Comprimento: 25,5cm  
Diâmetro externo: 1,2cm  
Diâmetro interno: 0,6cm

2 Comprimento: 29,5cm  
Diâmetro externo: 1,2cm  
Diâmetro interno: 0,6cm

3 Comprimento: 110cm

## COMPRESSÍMETRO PARA SISTEMA DE CIRCUITO DE COMBUSTÍVEL GASOLINA

52599 230,00€

4,00 - 5 60  
Kg SUB

0-145 PSI

0-1000 KPA



- O kit inclui todas as ferramentas necessárias para verificar o sistema de injeção de combustível na maioria dos carros de produção nacional e estrangeira.
- Em no kit ficam incluídos um instrumento de medição de 3-1/2 polegadas, com leituras de exibição de 0-145 psi e 0-1 000 kPa, e outro instrumento de medição de 2-1/2 polegadas com dois modos de exibição das leituras.
- Todos os adaptadores, medidores e conexões de mangueira estão equipados com um sistema de conexão rápida.



## MEDIDOR DE COMPRESSÃO DIESEL

52489 58,00€

2,15 - 6 144  
Kg SUB

- Ford, BMW, Mercedes Benz, VW, Citroën, Mitsubishi, Toyota, Peugeot, Renault, Volvo, Mazda.

- Kit completo para medir a compressão de veículos diesel.
- Grande variedade de adaptadores para medir na maioria de veículos do mercado.
- Sistema de enganche rápido para trabalhos em locais de difícil acesso.
- Adaptador em ângulo e adaptador de roscas de M18 e M24.
- Dispõe de válvula de descarga e de sistema de retenção de leitura.

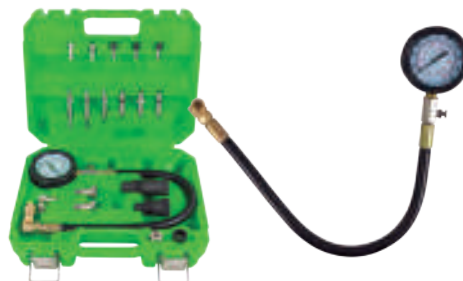

0-1000 PSI  
0-70 Kgs/cm<sup>2</sup>

M18x1.5mm  
M24x2.0mm  
M24x1.5mm



M10x1.0x68mm  
M10x1.25x54mm  
M10x1.25x68mm  
M12x1.25x45mm

## KIT DE TESTE DE COMPRESSÃO DIESEL

51893 690,00€

4,25 - 3 54  
Kg SUB

0-1000 PSI  
0-70 Kgs/cm<sup>2</sup>



- Para diagnóstico de compressão para sistemas de injeção diesel.
- Abrange até 70kg/cm<sup>2</sup> (1.000PSI).
- Relógio de medição em borracha, com adaptador em ângulo e prolongadores para trabalhos em locais de difícil acesso.
- Apto para uso na maioria de motores diesel do mercado.
- Com adaptadores de gama Alfa, BMW, Chrysler, Daewoo, Fiat, Ford, Hyundai, Isuzu, Land Rover, LDV, Mazda, Mercedes, Mitsubishi, Nissan, Opel, PSA, Renault, Suzuki, Saab, Toyota, VAG, Opel, Volvo diesel.
- Injector : M20, M22, M24 e Ford.

## COMPROVADOR DE PRESSÃO PARA DIESEL E GASOLINA

53490 275,00€

5,50 - 2 40  
Kg SUB

- Alfa Romeo, BMW, Chrysler, Citroen, Daewoo, Fiat, Ford, Honda, Hyundai, Isuzu, Jeep, Kia, Lada, Lancia, Land Rover, LDV, Mazda, Mercedes, MG, Mitsubishi, Nissan, Peugeot, Renault, Rover, Saab, Ssangyong, Suzuki, Toyota, VAG, Vauxhall/ Opel, Volvo.

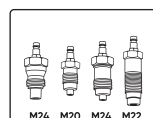

M24 M20 M24 M22

Ø 10, 12, 14, 18mm



# JOGO PARA REPARAR ROSCAS DE VELAS DIESEL

52076 111,00€

0,85 - 10 36



1. Ferramenta instalação de casquilho - 2uds.
2. Pega para varilha - 1ud.
3. Casquilhos M8 x 1,0 - 5uds.
4. Casquilhos M10 x 1,0 - 5uds.
5. Casquilhos M10 x 1,25 - 5uds.
6. Casquilhos M12 x 1,25 - 5uds.
7. Bujão c/ extremidades s/roscas - 3uds.
8. Barra de instalação de casquilhos - 1ud.

- A. Macho de roscar M14 x 1,25 (para casquilhos de M12 x 1,25) - 1ud.
- B. Macho para abrir roscas M12 x 1,25 - 1ud.
- C. Macho de roscar M12 x 1,0 (para casquilhos de M10 x 1,25) - 1ud.
- D. Macho de abrir rosca M10 x 1,25 - 1ud.
- E. Inserção de corte M10 x 1,0 (para roscas de M8 x 1,0) - 1ud.
- F. Inserção de corte M8 x 1,0 - 1ud.

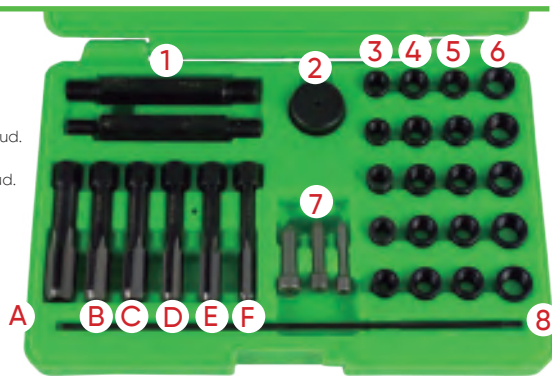

REF.	CARACTERÍSTICAS	Kg	Sub	ff	€
11893	Helicóidais M8x1,0	0,01	5		7,00€
11894	Helicóidais M10x1,0	0,01	5		7,00€
11895	Helicóidais M10x1,25	0,05	5		8,65€
11896	Helicóidais M12x1,25	0,01	5		8,80€

## KIT REPARADOR DE VELAS DE AQUECIMENTO

52305 106,00€

1,79 - 10 180



16  
PCS

- EXTRATOR de velas de pré-aquecimento de 16 peças.
- Este kit é útil para a extração da vela partida ou presa.
- Universal e ideal para motores Mercedes-Benz CDI.
- Extraí as velas partidas ou presas M8 e M10.
- Inclui machos para rosca 1/4" M8 e broca de alta resistência de duplo tamanho M8 e M10.

## JOGO EXTRATOR DE VELAS INCANDESCENTES

52815 110,00€

0,95 - 5 280



- Útil especialmente concebido para extrair pontas de eléctrodos de aquecimento em caso de ruptura durante o processo de extração.

## EXTRATOR DE CONEXÕES DE AQUECEDOR - BOCA EM ÂNGULO

52816 28,10€

0,27 - 6 36 -



52817 23,50€

0,27 - 6 36 -

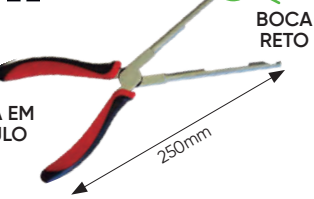

- Alicates para retirar as fichas no diesel aquecedores.
- Indicado para a remoção de rapidamente.
- Com conectores localizados em pontos de difícil acesso, os alicates permitem que você execute a operação sem risco de danos ao aquecedor ou outras partes de veículo.
- Empunhadura ergonômica emborrachada.

## KIT CHAVES TWIST DE 1/2" PARA EXTRAÇÃO DE FÊMEAS

52153 46,00€

0,93 - 5 20 640



- 17, 19, 21, 23, 27mm
- 1/2"

## KIT CHAVES 3/8" PARA EXTRAÇÃO DE PORCAS

51998 38,00€

0,69 - 5 20 360



9, 10, 11, 12, 13, 14, 15, 16, 17, 19mm

10  
PCS



NOVO DESIGN:  
PARTE HEXAGONAL

52962 42,00€

0,75 - 5 20 1500



6, 8, 10, 11, 12, 13, 14, 15, 16, 17, 19mm

11  
PCS

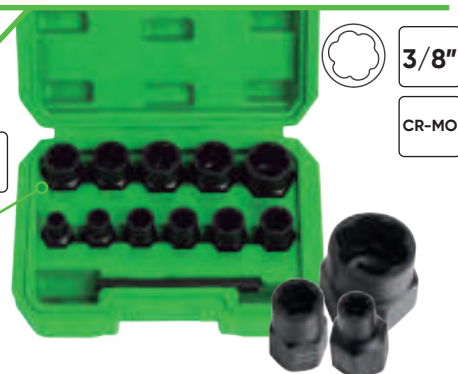

3/8"

CR-MO



## KIT DE REMOÇÃO DE PARAFUSO DE SEGURANÇA DA RODA

54253 166,00€



Simple de usar, Master Kit é capaz de remover praticamente qualquer porca de travamento de roda. O kit inclui proteções, que protegem a roda contra qualquer dano.

Muito eficaz, uma ferramenta obrigatória em qualquer oficina.

O kit contém dois tamanhos de lâminas de corte de impacto para encaixar as porcas de travamento mais comuns, cortando o aro externo.

Também estão incluídas três lâminas de dupla face para moldar diretamente na forma do soquete Universal - Remove uma ampla variedade de tamanhos, tipos e perfis, incluindo aqueles com colares giratórios.

Inclui driver de impacto e punção.



UNIVERSAL

9 PCS

## KIT DE PARAFUSO DE SEGURANÇA PARA BMW

53208 126,00€



- BMW Serie 1 F20/F21.
- BMW Serie 3 F30/F31.
- BMW Serie 4 F32/F34/F36.
- BMW Serie 5 F10/F11.
- BMW Serie 6 F12/F13.
- BMW Serie 7 F01/F02/F04.

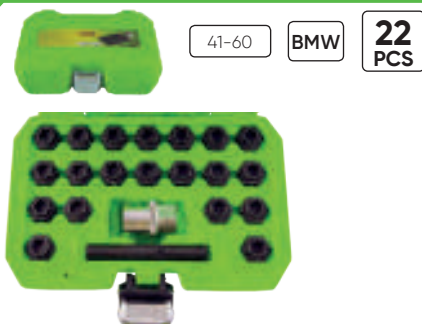

41-60

BMW

22 PCS

## KIT DE PARAFUSO DE SEGURANÇA VW

53207 118,00€

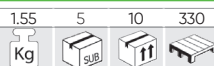

- |            |             |
|------------|-------------|
| b51 / 6pt  | b62 / 17pt  |
| b52 / 7pt  | abc0 / 10pt |
| b53 / 8pt  | abc1 / 11pt |
| b54 / 9pt  | abc2 / 13pt |
| b55 / 10pt | abc3 / 14pt |
| b56 / 11pt | abc4 / 15pt |
| b57 / 12pt | abc5 / 16pt |
| b58 / 13pt | abc6 / 17pt |
| b59 / 14pt | abc7 / 19pt |
| b60 / 15pt | abc8 / 20pt |
| b61 / 16pt | abc9 / 21pt |



23 PCS

VW

## KIT DE PARAFUSO DA SEGURANÇA PARA BMW

52802 54,00€



- 30/13 PT, 31/15 PT, 32/16 PT, 33/17 PT, 34/18 PT, 35/19PT, 36/20 PT, 37/21 PT, 38/22 PT, 40/23 PT

- Útil para remover os parafusos.



10 PCS

BMW



## KIT DE PARAFUSO DA SEGURANÇA PARA VAG

52823 124,00€

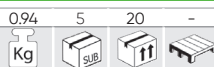

VAG

A, B, C, E, F, G, H, I, J, L, M, N, P, Q, R, S, T, V, W, X

22 PCS

- Especialmente concebido para remover os parafusos de segurança nas rodas veículos Volkswagen, cobrindo praticamente 100% da frota de veículos VW no mercado.

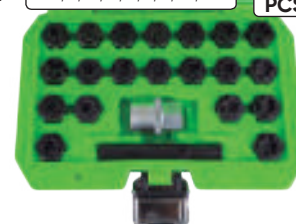

## KIT DE PARAFUSO DA SEGURANÇA PARA MERCEDES

53328 76,00€

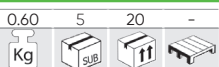

- Classe A, B, C, GLK, CLC, CLS, CLK, E, SL, SLK, M, C300, C250, C350, E320, 204, 211, 212, R.

MERCEDES

5A, 5C, 5D, 5E, 5F, 5G, 5N, 5L, 5P, 5X

12 PCS



## KIT DE REPARAÇÃO DE ROSCA PARA PINOS DE RODA

53652 53,00€

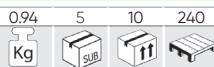

- M12x1.25 - PSA
- M12x1.5 - MERCEDES BENZ / BMW
- M12x1.75 - VOLVO
- M14x1.5 - VAG



- Conjunto de ferramentas para reparar e recondicionar os parafusos das rodas, bem como ancorá-lo à rosca fêmea do veículo; útil em roscas parcialmente danificadas.

## EXTRATOR DE BOBINA DE IGNIÇÃO PARA VW

51495 59,00€



- Para retirar e instalar as bobinas de encendido com tampa de motores de injeção de VW CYL 8 e 12 / 5 e 6 CYL, VW GOLF, BORA, 4 e 5 CYL, VW Passat, 6 CYL, Sharan VW, Touareg, Phaeton.

- Para retirar e instalar as bobinas de encendido com etapa de potência de VW Polo, Golf 1.4, 1.6i, 1.4i CADDY, BORA 1.4, 1.6i Phaeton, Passat, Touran 1.6i, Transporter T4.



VW

## REPOSIÇÕES DISPONÍVEIS



DISCO DE REPARO

REF.	CARACTERÍSTICAS	Kg	tt	€
14344	M12x1.25	0,49	20	11,00€
14345	M12x1.5	0,50	20	11,00€
14346	M14x1.5	0,46	20	11,00€



PARAFUSO DE REPARO

REF.	CARACTERÍSTICAS	Kg	tt	€
14340	M12x1.25 - PSA	0,05	20	10,50€
14341	M12x1.5 - MERCEDES / BMW	1,14	20	10,50€
14342	M12x1.75 - VOLVO	1,12	20	10,50€
14343	M14x1.5 - VAG	1,29	20	10,50€



## EXTRATOR DE PARAFUSOS PARTIDOS

51496 8,00€

5  
PCS

0,12	12	72	2016
Kg			

- Nº 1: 1/8" - 1/4" (M 3-6)
- Nº 2: 1/4" - 5/16" (M 6-8)
- Nº 3: 5/16" - 7/16" (M 8-11)
- Nº 4: 7/16" - 9/16" (M 11-14)
- Nº 5: 9/16" - 3/4" (M 14-18)



- Fabricados a partir de um tratamento térmico de aço cromo molibdênio.
- Conseguem uma rápida eliminação com a ajuda das hélices actuando como parafuso.

## KIT EXTRATOR DE MACHOS DE ROSCAR QUEBRADOS

53502 38,70€

9  
PCS

0,55	5	20	900
Kg			

- #2 M5
- #3 M6
- #4 M8
- #5 M10
- #6 M12
- #7 M14
- #8 M16
- #9 M20
- #10 M22



## JOGO DE CHAVES EXTRATOR DE PERNOS 1/2"

52833 39,30€

1/2"

0,80	5	20	-
Kg			



6, 8, 10, 12mm

### REPOSIÇÕES DISPONÍVEIS

REF.	DESCRIÇÃO	Kg			€
14211	6mm	0,10	20	100	11,00€
14212	8mm	0,10	20	100	12,00€
14213	10mm	0,20	20	100	12,00€
14214	12mm	0,20	20	100	14,00€

## JOGO DE ABOCARDADO DE TUBOS

52700 20,50€

3/16, 1/4, 5/16, 3/8, 1/2

0,95	6	12	468
Kg			

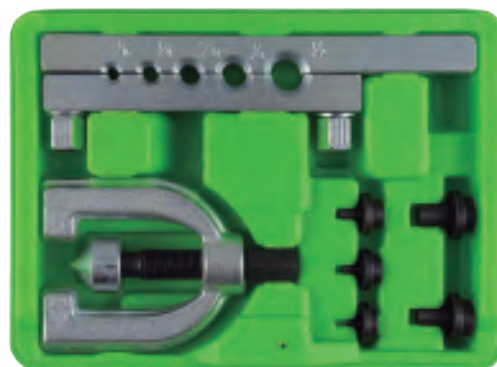

## CHAVE DE VELA ARTICULADAS

52691 54,00€

8, 9, 10, 12, 14, 16mm

3/8"

0,79	6	24	480
Kg			



COM FIXAÇÃO MECÂNICA



## CHAVE DE VELA MAGNÉTICA

52317 19,90€

250mm 3/8"

0,30	12	72	2880
Kg			

Ø16mm



52316 18,90€

0,20	12	48	2880
Kg			

Ø14mm



## CHAVE DE VELAS HEX.

10054 2,90€

10055 3,90€

1/2"

0,08	10	100	-
Kg			

0,14	10	100	-
Kg			

16mm



21mm



BORRACHA DENTRO





## KIT DE EXTRAÇÃO DE POLIAS DE 30 PEÇAS

52293 98,00€

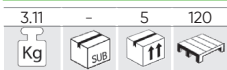

- 1/2" T50 c/33 dentes 19mmX33T -110mmL.
- 1/2" M10 c/33 dentes 19mmX33T - 110mmL.
- H15x33 dentes 15mmx33T - 30mmL.
- H22x33 dentes 22mmx33T - 30mmL.
- H22 - 30mmL.
- H17x4 Pins especial H17x4Pins - 30mmL.
- 1/2"Dr. xH10 Bit adaptador.
- H8xH10 Punta 75mmL.
- H10xH10 Punta 75mmL.
- M8xH10 Punta 75mmL.
- M10xH10 Punta 75mmL.
- T40 xH10 Punta 75mmL.
- T50xH10 Punta 75mmL.
- M10xH12 Punta 64mmL.
- Especial H22xH28 - 30mmL.
- Especial H19xH28 - 30mmL.

- 1/2"Dr.xM10 punta M10 - 140mmL.
- 3/8"Dr.xM10 c/31 dentes. - 14mmx31T- 85mmL.
- Especial H21xH28 - 30mmL.
- Especial H17 - 35mmL.
- Especial H38x3 Pins- 20mmL.
- Especial 15mmx33T- 30mmL.
- H10xFH10 x68L. 68mmL.
- T50xH12 Bit 64mmL.
- Especial H17xH21-30mmL.
- Especial H15xH28 - 30mmL.
- 3/8"Adaptador x10mm.
- 1/2"Dr.xT50 punta T50 140mmL.
- 1/2"Dr.xT50 punta T50 200mmL.
- 1/2"Dr.xM10 punta T50 200mmL.

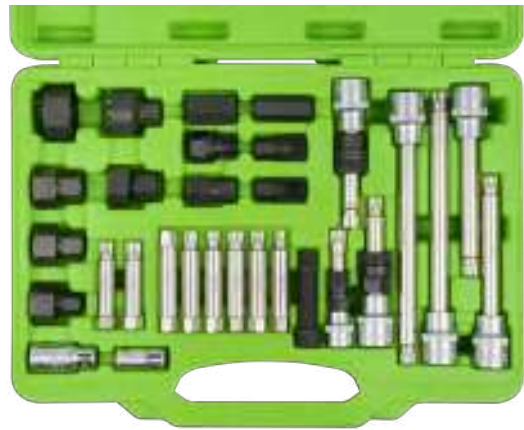

30  
PCS

## KIT DE EXTRAÇÃO DE POLIAS DE 18 PEÇAS

51259 58,00€

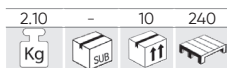

- 3 x Chaves combinadas: T50x113mm, M10x113mm, M10x90mm.
  - 1 x Chave dentada: M10x140mm.
  - 2 x Adaptadores hexag. 19 e 22mm.
  - 3 x Chaves hexagonais: 22x28mm, 19x28mm, 21x28mm.
  - 1 x Adaptador Hex. 1/2" x 10mm.
  - 1 Punta M10x12x64L.
  - 6 x Pontas 10mm (varilha hexagonais) x 75mm.
- Medidas: T40, T50, M8, M10, H8, H10.



18  
PCS

### REPOSIÇÕES DISPONÍVEL



10494 6,50€

CHAVE D'EXTENSÃO  
14cm



10495 3,00€

PONTA H10



10496 3,00€

PONTA H8



10497 3,00€

PONTA M10



10498 3,00€

PONTA M8



10499 3,00€

PONTA T40



10500 3,00€

PONTA T50



10501 8,10€

CHAVE PONTA  
XZN M10 90mm



10502 3,50€

PONTA M10 TORX



10485 8,10€

CHAVE PONTA  
XZN M10 110mm

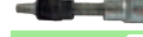

10486 8,00€

CHAVE PONTA  
TORX T50 110mm

## JOGO DE CHAVES CURVADAS PARA EXTRAÇÃO DE CORREIAS 12 FACES

52832 75,00€



12, 13, 14, 15, 16,  
17, 18, 19mm



CABEÇA  
INTERCAMBIÁVEL

## ALAVANCA PARA AFROUXAR CORREIAS

52690 54,00€



13, 15, 16,  
18mm



13, 14,  
15mm



- Alavanca de 230 mm com acionamento de 1/2".
- Alavanca de 585 mm com acionamento de 3/8".
- 3 chaves de 13,14,15 mm e 3/8" quadradas.
- 4 soquetes hexagonais de 3/8" quadrado e 13,15,16,18mm.

3/8"

1/2"

3/8"

1/2"

230mm

585mm

## EXTRATOR DE TORCAS FÊMEAS

51368 19,00€

0,41	5	50	1000
Kg	Sub	ff	ff

∅  
↑ 42mm  
↓ 33mm



## EXTRATOR DE PORCAS FÊMEAS AXIAIS

51369 28,00€

0,55	6	36	756
Kg	Sub	ff	ff

∅  
↑ 42mm  
↓ 35mm



## EXTRATOR DE PERNOS

51414 14,00€

0,59	5	40	1440
Kg	Sub	ff	ff

∅  
↑ 20mm  
↓ 15mm



## ALINHADOR DE QUEDAS (VAG)

53488 61,00€

2,75	-	5	200
Kg	Sub	ff	ff

- Permite que uma única pessoa ajuste o ângulo de queda da roda.

- Inclui:  
Fuso hexagonal de 22 mm.  
3 comprimentos diferentes:  
- 75mm: Seat - Toledo | VW - Jetta / Golf.  
- 85mm: Seat - Córdoba | VW - Polo /  
95  
- 115 mm: Chrysler - Voyager.



## COMPROVADOR ANGULAR MAGNÉTICO

52318 73,00€

0,64	6	24	336
Kg	Sub	ff	ff

-6° / +6°

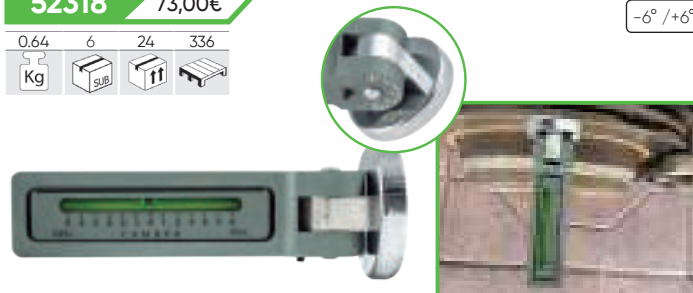

## EXTRATOR DE POLIAS ARMÔNICO

52624 28,00€

1,25	-	5	450
Kg	Sub	ff	ff

- Contém:  
2 x parafuso 5/16" de 4".  
2 x parafuso 1/4" de 3".  
3 x parafuso 5/16" de 2".  
3 x parafuso 1/4" de 2".  
1 x 5" parafuso de pressão de ALU.  
1 x ponta giratória 3/4".



## EXTRATOR DE POLIAS ENCRAVADAS

51500 29,00€

1,55	-	10	640
Kg	Sub	ff	ff

40-168mm

- Apto para o uso em cambotas, alternadores, unidades de A/C e bombas de água.  
- Os braços de perfil baixo permitem um fácil acesso a zonas difíceis do motor.  
- Desenhado para a extração da cambota encravada, amassada e de polias auxiliares.  
- Rang: 40-160mm.



## EXTRATOR DE POLIAS UNIVERSAL

53664 38,00€

0,80	-	10	2500
Kg	Sub	ff	ff

- Uso universal.  
- Opção de multiposição para atender à maioria das polias.  
- Ideal para trabalhar em áreas estreitas, economizando tempo de trabalho.



## CHAVE DE EMBREAGEM ESPECIAL FIAT

52190 8,00€

0,39	-	10	1000
Kg	Sub	ff	ff

220x110mm



Facilita o acesso à carilha da forquilha para a sua extração e posterior substituição do disco.  
Rosca: 1,5cm de compr. x 0,5cm diam.  
Especificações:  
Útil para desmontar forquilha em embreagens de Fiat Ducato



## GANCHOS PARA EXTRAIR JUNTAS

53053 12,00€

0,21	10	50	1000
Kg	Sub	ff	ff

1x15,5cm / 1x16,5cm / 1x12cm





## ALAVANCA PARA BRAÇOS DE SUSPENÇÃO

**51902** 84,00€

4,90	-	1	66

- Comprimento: 118cm.
- Diâm. Tubo: 3,5cm.
- Distância de anclajes: 50, 45, 40, 35, 30 cm.
- Anclaje de 15x13cm.



**REPOSIÇÃO ÂNCORA DE FIXAÇÃO PARA REF. 51902**

**10953** 12,50€



## KIT DE FERRAMENTAS PARA REMOÇÃO DE BRAÇOS DE DIRECÇÃO

**52639** 123,00€

5,05	-	4	84

- Ø 30-35mm
- Ø 35-40mm
- Ø 40-45mm



## ALINHADOR DE DIRECÇÃO

**51991** 48,00€

1,15	-	10	120

- Comprimento total aberto: 1950mm.
- Comprimento total fechado: 1100mm.
- Medida do parafuso: M6x15mm.
- Tubo exterior de 20x20 de aluminio.
- Tubo interior de 16x16 de ferro zincado.

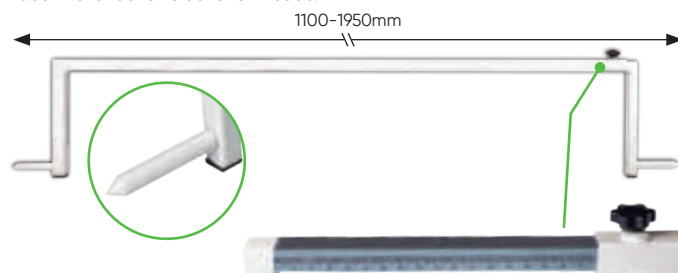

## EXTRATOR PARA BRAÇO DE DIRECÇÃO

**52640** 52,00€

1,80	-	4	256

Ø 28-35mm

**52641** 55,00€

2,20	-	4	140

Ø 35-45mm



## EXTRATOR PARA BRAÇO DE DIRECÇÃO

**52874** 82,00€

1,20	4	20	1500

Ø 9-20mm

**52875** 79,00€

1,25	5	20	1500

Ø 14-23mm



## KIT PARA EXTRAÇÃO DE AIRBAGS

**51501** 38,00€

0,88	5	20	240

- Pontas 0,5 PC 1/4" x 87mm (L):
- 2x Torx: T25 (para BMW), T30 (para Audi, Opel, Renault, VW).
- 2x Torx (inviolable): T25H (Para BMW), T30H (Para AUDI, BMW, Mercedes, Opel).
- 1x Hex: 5 mm (Para AUDI).

- 0,7 PC Ferramenta extração:
- 1x para Airbag conductor. 1999-04 nuevo estilo de carroçeria de VW Passat, JETTA, GOLF.
- 2x Para VW Passat B5, POLO, LUPO; AUDI A4, A6, Skoda Superb.
- 2x Para VW GOLF 4, New Beetle, SEAT, SKODA FABIA, AB Oktavia BJ.99.
- 1x Para VW GOLF 4 (BJ, 1998-2004), VW PASSAT BJ.1997 AB, AB BORA BJ.1999.
- 1x Para U.A VW modelle: AB PASSAT BJ.2000.

**12 PCS**

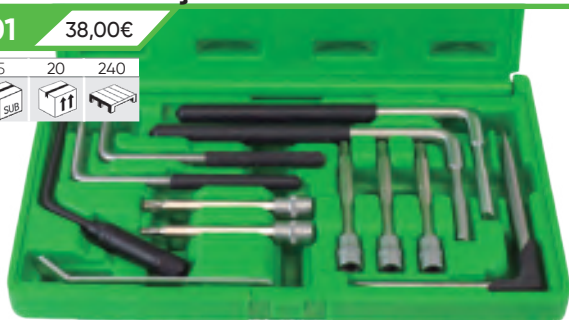

## EXTRATOR DE RÓTULAS HIDRÁULICO

53384 165,00€

7.30	-	2	74
Kg	sub	ff	tr



Visão geral: 100mm.  
Largura: 35mm.

10kg



1 1/2"-16UNF

M20X1.5

FUSO HIDRÁULICO

15253  
62,00€

## JOGO DE 5 EXTRATORES DE RÓTULA

51123 91,00€

5.29	-	2	136
Kg	sub	ff	tr



- Jogo de EXTRATORes versáteis.
- Permite a fácil extração dos tipos mais populares de articulações de rótulas e demais.
- O tipo de separador de prensa de junta, permite o etiro da junta de rótula sem estragos aos carregadores e a outras peças que outro tipo de EXTRATORes podem causar.

## JOGO DE EXTRATORES DE RÓTULAS

51490 36,00€

1.88	-	5	300
Kg	sub	ff	tr



- Forquilhas feitas de aço cromo vanádio reforçado de alta resistência.
- Ambos cabos são intercambiáveis.
- 1 cabo desenhado para utilizarse com um martelo pneumático.

- Conteúdo:  
1 cabo para usar com um martelo.  
3 forquilhas: 11/16, 15/16" e 1-1/8".

## COMPROVADOR DE EIXOS

52541 45,00€

2.10	-	10	110
Kg	sub	ff	tr



- Jogo para detectar deficiências: em rolamentos, sinoblocos silenciosos, rolamentos de rodas, articulações axiais, rolamentos, estabilizadores, etc.

## EXTRATOR UNIVERSAL DE BOLA

52642 32,00€

1.32	5	20	600
Kg	sub	ff	tr

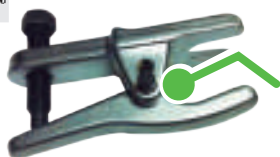

- Abertura Max: 60mm.
- Abertura Min: 20mm

17 - 22mm

2 MEDIDAS AJUSTÁVEL

## EXTRATOR DE RÓTULAS

52699 22,00€

0.80	5	30	1050
Kg	sub	ff	tr



- Abertura: 15-50mm.

Ø 18-22mm

## JOGO DE EXTRATORES DE GUILHOTINA

51125 88,00€

4.72	-	5	160
Kg	sub	ff	tr

Capacidade das guilhotinas:

- Set Polegada:  
1/4", com 30mm e 50mm.  
Parafuso de 3/8" de 9,5x125 - 24 UNF.  
Cabeça de 3/8" x 16 UNC.

- Set 2 Polegadas:  
1/4" - 3 1/2", com 50x75mm.  
Parafuso de 1/2" de 12,7x135 - 20 UNF.  
Cabeça de 3/8" x 16 UNC.



## EXTRATOR DE GUILHOTINA

52626 46,00€

3.65	-	5	800
Kg	sub	ff	tr

75 - 105mm

52627 120,00€

6.50	-	2	231
Kg	sub	ff	tr

105 - 150mm

- Para extração do rolamentos em autos e comerciais ligeros.
- Extrae as caixas de cambio, polias e volantes.



## CHAVE PONTA XZN ESP. VAG

12029 5,50€

0.17	5	100	1500
Kg	sub	ff	tr



INVOLÁVEL  
M16X58MM



12030 6,50€

0.25	8	80	-
Kg	sub	ff	tr



INVOLÁVEL  
M16X100MM



CrV

1/2"





# CONJUNTO UNIVERSAL DE EXTRATORES DE 2/3 GARRAS

**53701** 188,00€

8,45 - 1 44

Kg SUB

**13**  
PCS

- Faixa de trabalho 2 pernas: 45-120mm.
- Faixa de trabalho 3 pernas: 50-130mm.
- Profundidade da faixa 100, 200, 250 mm.
- Completude:
  - Guia central de 3 pernas.
  - Guia central de 3 pernas.
  - Pino 275mm.
  - Pino: 165mm.
  - Pernas longas com alças: 250mm.
  - Pernas médias com alças: 200mm.
  - Pernas curtas com alças: 100mm.



**PONTA GARRA PARA REF. 53701**

14611 0.10 50  
12,00€ Kg

**PARAFUSO PARA REF. 53701**

165mm

14612 0.15 20  
11,00€ Kg

**PARAFUSO PARA REF. 53701**

275mm

14613 0.30 20  
13,50€ Kg

## JOGO DE EXTRAÇÃO DE ROLAMENTOS

**51124** 88,00€

3,20 - 5 120

Kg SUB

- Contém:
  - EXTRATOR Universal (38,5mm).
  - Adaptador de 3/8" a 1/2" (10-14mm).
  - Adaptador de 9/16" a 11/16" (15-19mm).
  - Adaptador de 5/8" a 1" (18-25mm).
  - Adaptador de 1" a 1 1/4" (25-32mm).



## EXTRATOR DE TERMINAIS COM SEIS CONECTORES

**54112** 18,00€

0,04 20 100 1800

Kg SUB

## EXTRATOR UNIVERSAL PARA INTERIORES/EXTERIORES

**53250** 85,00€

4,80 - 4 72

Kg SUB

- Material: Cromo molibdeno SD45C.
- Para motores VW / Audi DIESEL.
- Aplicações: 1.4 SDI, TDI, 1.9 D, SDI, TDI, TDI (PD), 2.0 TDI (PD) & (PD 4-VALVES), 2.5 TDI / TDI(PD), 2.8 TDI (PD), 2.7, 3.0 TDI (Common Rail), 4.2 TDI (Common Rail).

- Material: aço.
- Extração externa: de 40 a 80mm.
- Extração interna: de 50 a 150mm.
- Inclui:
  - Extrator de três garras exterior.
  - Triplas garras int. para extração de rolamentos.
  - 1 Extrator profundo.
  - 1 conector de parafuso.



## KIT DE EXTRATORES DE ROLAMENTOS COM ESFERAS FALSAS

**53062** 99,00€

2,41 - 10 160

Kg SUB

5, 6, 8, 9, 11, 12,5mm

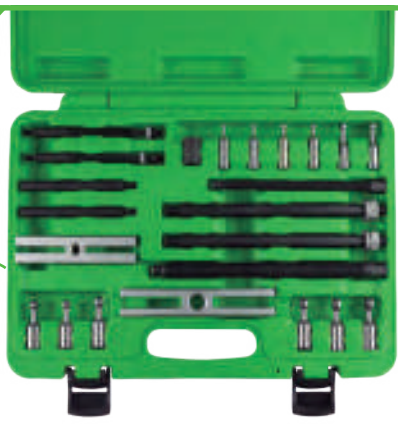

IVA não incluído

## EXTRATOR DE 2 GARRAS

**52727** 34,60€

0,20	10	60	1200
Kg	Sub	ff	ff

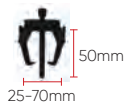

**52728** 68,00€

120	5	10	500
Kg	Sub	ff	ff

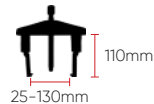

**52727**



## EXPOSITOR DE EXTRATORES

**53146** 30,50€

0,70	5	10	140
Kg	Sub	ff	ff



**52729** 128,00€

3,39	-	3	240
Kg	Sub	ff	ff

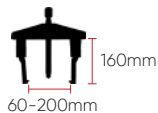

**52730** 288,00€

8,57	-	2	108
Kg	Sub	ff	ff

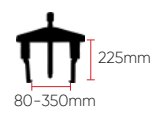

**52728**  
**52729**  
**52730**

- EXTRATORes não incluídos.

## EXTRATOR DE 3 GARRAS

**52731** 38,00€

5,30	4	24	504
Kg	Sub	ff	ff

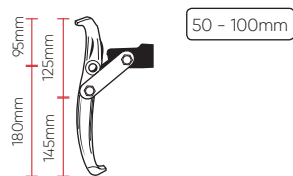

**52732** 58,00€

2,54	5	20	200
Kg	Sub	ff	ff

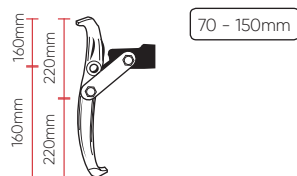

**52733** 98,00€

5,20	-	4	112
Kg	Sub	ff	ff

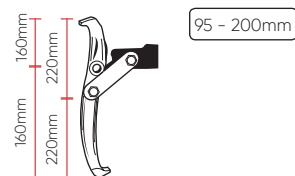

## EXTRATOR DE 3 GARRAS CONVERSÍVEL EM 2 REVERSÍVEL

**52010** 80,00€

0,50	4	40	360
Kg	Sub	ff	ff

- Medida da Garra: 90mm.
- Medida do pasador: 124mm.
- Unha du agarre: 12mm.
- Comprimento de cruzeta: 66mm.
- Profundidade: 75mm.



**52296** 119,00€

1,57	4	8	120
Kg	Sub	ff	ff

- Medida de garra: 132mm.
- Medida do pasador: 217mm.
- Unha du garra: 14mm.
- Comprimento de cruzeta: 95mm.
- Profundidade: 110mm.



**52298** 177,00€

2,65	3	6	396
Kg	Sub	ff	ff

- Medida de la garra: corta 134mm, larga 207mm.
- Medida do pasador: 218mm.
- Unha du garra: corta 13mm, larga 15mm.
- Comprimento de cruzeta: 95mm.
- Profundidade: 110 - 180mm.

GARRA CURTA  
E LONGA



**52297** 172,00€

3,33	-	6	36
Kg	Sub	ff	ff

- Medida da garra: 210mm.
- Medida do pasador: 313mm.
- Unha du garra: 15mm.
- Comprimento de cruzeta: 152mm.
- Profundidade: 180mm.



## KIT DE 52 PEÇAS PARA EXTRAÇÃO DE EQUIPAMENTOS DE AUDIO

**53388** 90,00€

1,50	-	5	120
Kg	Sub	ff	ff



**52**  
PCS

## KIT DE ACESSÓRIOS PARA EXTRAER EQUIPAMENTOS DE AÚDIO

**51126** 18,00€

0,20	10	100	1500
Kg	Sub	ff	ff



**10**  
PCS

- Blaupunkt, Clarion, Skoda, BMW, Audi, Grundig, JVC, Pioneer, Volkswagen, Mercedes, Opel Doppel-Kugel-Inbus, Porsche, Becker, Kenwood, Sony, Panasonic, Fiat Brava, Ford.

- Blaupunkt, Peugeot, Clarion, Skoda, Alpine, BMW, Opel, Audi, Grundig VDO, JVC, Pioneer, Volkswagen, Mercedes, Porsche, Renault, Becker.



## KIT DE 23 EXTRATORES DE TERMINAIS

53393 118,00€

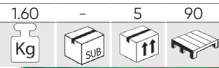

23  
PCS

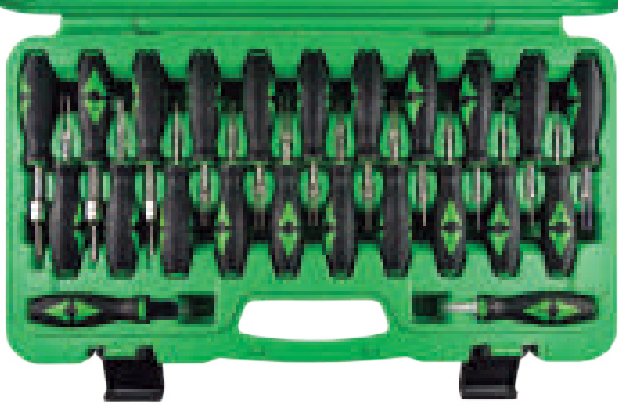

- BMW, Audi, Volkswagen, Mercedes, Opel, Porsche, Jaguar, Saab, Seat, Ford, Skoda, Renault, Citroën, Chrysler, Fiat, Honda, Mazda, Mitsubishi, Toyota.

## KIT DE 19 EXTRATORES DE TERMINAIS

53391 86,00€

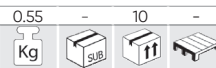

A, B, C, D, E, F, G, H, I, J, K, L, A1, B2, C3, D4, E5, F6, G7

19  
PCS



## EXTRATOR DE CASQUILHOS FRONTAIS PARA VAG

52432 35,00€

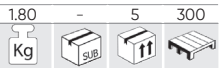

- Útil para VW POLO modelo 2002.  
- Facilita a troca dos casquilhos de borracha do eixo frontal.

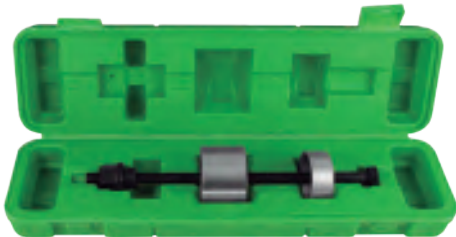

## EXTRATOR DE CASQUILHOS PARA VAG

52270 109,00€

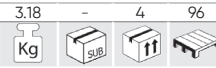

- Contém:  
- Extensão de eixo.  
- Porca de aperto de M10 x 1,25.  
- Cabeça adaptadora de aço carbônico.  
- Separador.  
- Peça de pressão.  
- Mandril centrado em aleação de alumínio.



## KIT CHAVES COM DENTES EXTERIORES

52834 195,00€

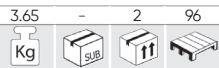

- Kit para a extração de porcas com fenda em **veículos industriais**.

11  
PCS

1/2"

CR-MO

mm  
22x3.3  
26x3.8  
30x4.3  
33x4.0  
37x4.8  
44x5.3  
50x5.8  
56x5.8  
63x6.3  
69x6.8  
75x6.8



## KIT CHAVES COM DENTES INTERIORES

52835 272,00€

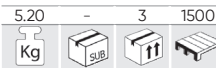

- Kit para a extração de porcas com fenda em **veículos industriais**.

10  
PCS

1/2"

mm  
26x5.3  
1.2x6.25  
34.2x6.3  
38.2x6.65  
42.2x7.3  
50.1x8.25  
58.2x9.8  
74.6x11.9  
82.2x13.25  
87.7x13



# FERRAMENTA UNIVERSAL DE REMOÇÃO / INSTALAÇÃO DE ROLAMENTOS E CASQUILHOS

52494

227,00€

17.35 - 1 48  
Kg SUB ff



- Útil para instalar e desinstalar casquilhos e rolamentos de suspensão.
- Peças de duplo tamanho e varilhas de rosca de diferentes métricos.
- Medidas: M10, M12, M14, M16, M18.

12926

21,50€

M10



12927

21,50€

M12



12928

22,00€

M14



12929

23,00€

M16



12930

23,50€

M18



## KIT DE MONTAGEM PARA ROLAMENTOS

53058

193,00€

8.19 - 1 102  
Kg SUB ff



220mm Ø 12mm

Ø  
18, 19, 20, 21, 22, 23, 24,  
25, 26, 27, 28, 29, 30, 31,  
32, 33, 34, 35, 36, 37,  
38, 39, 40, 41, 42, 43,  
44, 45, 46, 47, 48, 49,  
50, 51, 52, 53, 54, 55,  
56, 57, 58, 59, 60, 61, 62,  
63, 64, 65, 74mm

## JOGO DE EXTRAÇÃO E INSTALAÇÃO DE ROLAMENTOS

53056

127,00€

8.32 - 2 64  
Kg SUB ff

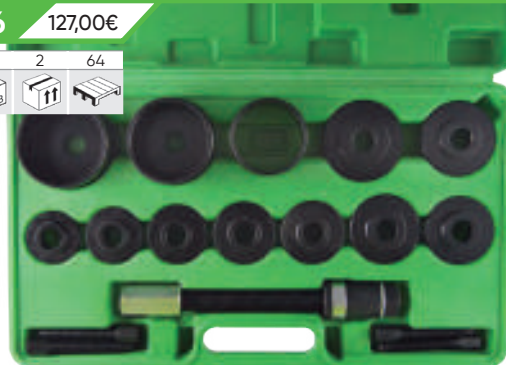

Ø 55.5, 59, 62, 65, 66,  
71.5, 73, 78, 84mm

Ø 75.5, 83mm

295mm Ø 69mm

## JOGO PARA INSTALAÇÃO DE ROLAMENTOS

51349

37,30€

1.00 - 10 180  
Kg SUB ff

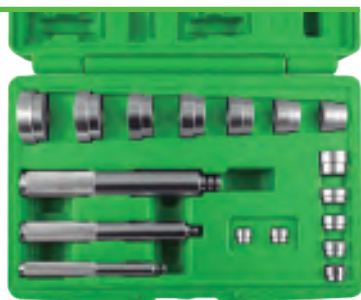

42 - 38mm  
40 - 35mm  
36 - 32mm  
30 - 28mm  
24 - 22mm  
27 - 25mm  
18 - 16mm  
20 - 18mm  
22 - 20mm  
12 - 10mm  
14 - 12mm  
16 - 14mm  
17 - 15mm

- Adaptadores de manutenção para porcas.
- Apto para todo tipo de eixo e rolamento.
- Medidas: de 10mm a 42mm.

## INSTALADOR AJUSTÁVEL DE RETENS

53129

84,00€

0.96 2 10 180  
Kg SUB ff

18 - 90mm





## JOGO PARA EXTRAÇÃO DE ROLAMENTOS

**52551** 151,00€

10.42	-	2	58

- Parafuso: 27mm
- Porca: 32mm
- Cilindros: 76, 82, 92, 101mm
- Parafuso reforçado para uso com ferramentas de impacto.
- Eje de aço fosfato é projetado para evitar a corrosão.



Número	955-08	955-11	955-07	955-12	955-13	955-14	955-09	955-15	955-06	955-17	955-18	955-19	955-16
Diâmetro (mm)	55.7	63.3	67.8	70.7	71.9	71.7	72.8	73.4	74.7	77.4	81.4	83.3	88.4

## JOGO DE INSTALAÇÃO DE ROLAMENTOS E FREIOS INTERIORES

**53059** 52,00€

1.70	5	10	160

∅  
39,5, 44,5, 50, 59, 63,  
65, 72, 76, 81mm



## KIT DE REMOÇÃO E INSTALAÇÃO DE BUCHAS DE RODA E ROLAMENTOS

**54299** 227,00€

15,00	-	1	-



	8,6x10,9cm		8,9x17,6cm
	8,2x10cm		9,9x 17,6cm
	7,1x9,45cm		12x17,8cm

∅ 2,3mm

	5,3cm		5,8cm		6,5cm		6,6cm		6,8cm
	7,1cm		7,3cm		7,8cm		8,3cm		
	9,5cm		∅ 2,3cm		9,55cm		∅ 8,6cm		

**19**  
PCS



## EXTRATOR DE JUNTAS HOMOCINÉTICAS

**51364** 26,00€

2,00	-	5	280

∅  
31mm

140 - 240mm



## EXTRATOR DE POLIA

**51140** 64,00€

1,02	-	24	290

- Desenhado para manter a polia da árvore de cames fixa.
- Permite o ajuste do eixo central quando se dá a junção.
- Usando a barra rosca para extrair a polia.
- Parafusos de fixação: M6, M8.



# KIT DE FERRAMENTAS DE LIMPEZA DE BUCHAS, 14 PÇS

54069 29,50€

0.20	10	40	360
Kg	Sub	Box	Tray

Remove a sujeira e a corrosão da superfície dos cubos com pinos.

- 1 bico 8 mm com adaptador 1/2"
- 1 rebolo de eixo redondo e cabeça hexagonal de 8 mm.
- 2 almofadas removíveis com base autoadesiva.
- 5 rebolos de grão grosso, diâmetro externo de 40 mm.
- 5 rebolos de grão fino, diâmetro externo de 40 mm, diâmetro interno de 14 mm.
- Dimensões gerais de um conjunto: 30,5\*17\*2,5 cm
- Peso de um conjunto: 240 g



# EXTRATOR HIDRÁULICO DE BUCHAS DA RODA

53638 243,00€

13.35	-	1	32
Kg	Sub	Box	Tray

- Este kit inclui: 3 EXTRATORes / martelos: eixo hidráulico, parafuso e martelo de impacto, especialmente projectados para simplificar a remoção do cubo da roda e liberar o eixo do cubo sem danificá-lo.
- Para extração manual ou hidráulica.
- Com uma capacidade máxima de 10 TON.
- Martelo de 4 kg.
- Comprimento da barra: 57cm.
- Para 3, 4, 5 e 6 furos.

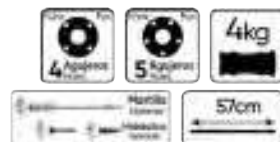

FUSO HIDRÁULICO

VAG (VW, AUDI, SEAT, SKODA), PSA (CITROËN, CITROËN DS, PEUGEOT), RENAULT, FORD, OPEL, BMW, MERCEDES BENZ

15253 62,00€

# REMOVEDOR DE ROLAMENTOS DE RODA COM A PLACA DESLIZANTE DE CHOQUE

53635 85,00€

6.50	-	2	80
Kg	Sub	Box	Tray

440 - 630mm

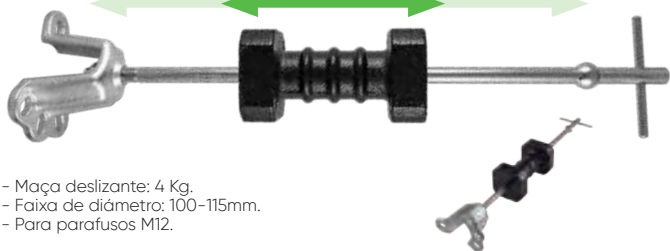

- Maça deslizante: 4 Kg.
- Faixa de diâmetro: 100-115mm.
- Para parafusos M12.

# SET DE EXPANSÃO PARA TUBOS DE ESCAPE

52637 48,00€

3.01	-	5	220
Kg	Sub	Box	Tray

1-1/8" - 1-3/4"  
1-1/2" - 2-1/2"  
2-1/8" - 3-1/2"



# SET DE 2 GANCHOS PARA EXTRAIR BORRACHA DA TUBO DE DESCARGA

52849 8,50€

0.22	10	40	480
Kg	Sub	Box	Tray



# KIT DE EXTRAÇÃO DE BRAÇO DE LIMPA PRARA-BRISAS

53463 98,00€

1.65	-	10	180
Kg	Sub	Box	Tray

- VW:** Polo, Lupo, Touareg, Porsche Cayenne.
- Opel:** Astra G, Zaphira B, Corsa C, Vectra C.
- Honda:** Jazz, CRV, FRV, Accord, Turnier.
- BMW:** 5º Modelo de EU 39 a 2005. 7º Modelo de E 38 a 2005
- Audi:** A3, A4, A5, A6. Audi Q7.
- Ford:** Galaxy, Alhambra.
- Mercedes:** A-Class, B-Class.



# EXTRATOR DE BRAÇO LIMPA-PÁRA-BRISAS

52454 12,90€

0.20	6	36	1152
Kg	Sub	Box	Tray



- Projectado com pernas finas e extremos acabados em latão para evitar qualquer tipo de dano na carroçaria, pintura ou vidro.
- Aplicável à maioria dos veículos do mercado.
- Seu manuseio permite uma extração segura dos limpa-pra-brisas evitando danos no braço.





## CHAVE DINAMOMETRICA COM CABEÇA INTERCAMBIAVEL 200NM

52913 292,00€

- Certificado de calibração de fábrica incluído.

1/2"

3,94	-	4	128
Kg	sub	ff	tbl

- Par de aperto: 40-200Nm.
- Cabeçales incluídos: Chaves 13, 14, 15, 17, 19, 22, 24, 27, 30mm.
- Cabeça catraca 1/2".
- Diferentes cabeças disponíveis separadamente.

18x14mm



## CHAVE DINAMOMÉTRICA

51262 51,00€

270mm

2-24 Nm  
0,2 - 2,4 M.Kg

1/4"

0,80	4	16	384
Kg	sub	ff	tbl



51338 53,00€

365mm

19-110 Nm  
1,9 - 11 M. Kg

3/8"

1,05	4	16	320
Kg	sub	ff	tbl



51127 56,00€

470mm

28-210 Nm  
2,9 - 21,4 M. Kg

1/2"

1,70	4	8	256
Kg	sub	ff	tbl



- Certificado de calibração de fábrica incluído.

## KIT DE REPARAÇÃO

51262R 14,00€

0,05	20
Kg	ff



51338R 14,00€

0,05	20
Kg	ff



51127R 14,00€

0,15	20
Kg	ff



IVA não incluído

## CHAVE DE TORQUE COM O APROFUNDAMENTO

- Certificado de calibração de fábrica incluído.

53081 115,00€

1,10	5	25	350
Kg	sub	ff	tbl

1/4"

4-20NM (36T)

375mm



53082 148,00€

1,90	4	8	168
Kg	sub	ff	tbl

1/2"

40-210NM (24T)

560mm



53972 550,00€

8,75	-	2	42
Kg	sub	ff	tbl

3/4"

1000-1.210mm

200-800 Nm  
21,4 - 81,6 Kg

SMC/M

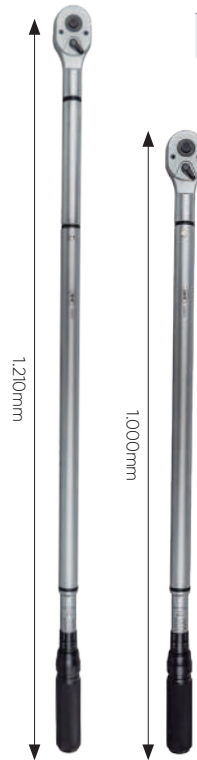

24

DINAMOMÉTRICAS



# CHAVE DINAMOMÉTRICA MECÂNICA

**51830** 94,00€

- Certificado de calibração de fábrica incluído.

1,00	-	12	300
Kg	sub	ft	mm

- Exactitude: CW: +/- 4%
- Alcance de operação: 2-10 N-m
- Unidades de selecção: N-m, in-lb.
- Comprimento (mm): 242mm
- Dedo: 1/4"
- Vida útil: 100.000 ciclos



# CALIBRE DE PROFUNDIDADE COM SUPORTE MAGNÉTICO

**52904** 61,00€

2,00	-	5	200
Kg	sub	ft	mm

- Medição: 0-10mm.
- Calibrado: 0,01mm.
- Esfera: 58mm.
- Base magnética: 40kg.



CALIBRE DE PROFUNDIDADE PARA REF. 52904

**13704** 21,00€

0,10	-	50	1500
Kg	sub	ft	mm

# DESMULTIPLICADOR DE ROQUETE 3/4" + REDUCTOR DE 1/2"

**51958** 422,00€

4,35	-	4	96
Kg	sub	ft	mm

- Características:
- Relação de transmissão 1:4.
- Relação de par 1:3.3.
- Par máximo de entrada: 303Nm.
- Par máximo de saída: 1000 Nm.



- Inclui:
- 1 Desmultiplicador de par.
- 1 Roquete manual.
- 1 Adaptador 1/2" M x 3/4" F.
- 1 Kit de desbloqueio.
- 1 ALAVANCA de extensão 90°.
- 1 ALAVANCA de extensão 350mm.

# GONIOMETRO 1/2"

**52583** 8,50€

0,20	4	48	864
Kg	sub	ft	mm



# GONIÓMETRO DE 1/2" MAGNÉTICO

**52794** 28,00€

0,48	6	24	288
Kg	sub	ft	mm

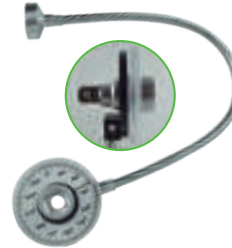

- Útil para apertar os parafusos de acordo com especificações determinadas pelos fabricantes de veículos e máquinas.
- Aperte feita pela catraca ou 3/4" chave de torque.
- Janela transparente para uma visão correta da medição.
- Faixa de medição 0-360.
- Em blister.

# APALPA-FOLGAS

**52433** 4,80€

0,10	10	50	1000
Kg	sub	ft	mm

0,05 - 1mm



# PÉ DE REI

**50937** 10,50€

0,24	10	50	1500
Kg	sub	ft	mm

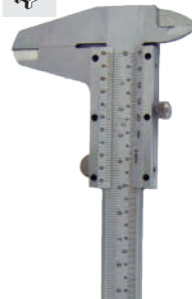

**50724** 28,00€

0,30	5	50	1200
Kg	sub	ft	mm



# MEDIDOR DE PROFUNDIDADE DIGITAL

**53042** 9,90€

0,05	10	100	2000
Kg	sub	ft	mm

0-25,4mm



# CALIBRE DE PROFUNDIDADE

**52873** 11,00€

0,04	5	300	1500
Kg	sub	ft	mm

0-40mm





## DESMULTIPLICADOR DE FORÇA COM AUMENTO

51919

89,00€

7,75	-	3	120
Kg	sub	if	

- Material: 40CR.
- Potência máxima : 5800Nm.
- Potência de trabalho: 3800Nm.
- Múltipla alcance 1:56.
- Inclui chaves de 32mm e 33mm de 1".



## DESMULTIPLICADOR DE FORÇA ARTICULADO

52796

98,00€

8,88	-	3	72
Kg	sub	if	

6.000Nm

- Use um camião com tampa de cubo de roda e protetor.
- Previne danos ao aro.
- Único no mercado.
- Fácil adaptação a qualquer veículo universal.
- Util para aparafusar sem esforço e desenroscar.

- Inclui:
- 1x chave 1" 32mm.
- 1x chave 1" 3mm.

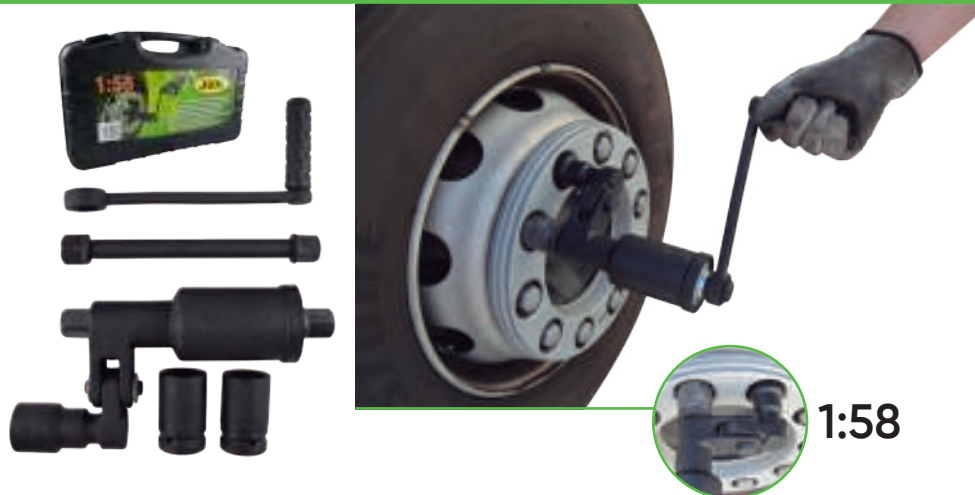

1:58

## DESMULTIPLICADOR DE FORÇA

52012

68,00€

2,34	-	4	128
Kg	sub	if	

- Inclui:
- 1 desmultiplicador de par.
- 1 ALAVANCA de extensão 90°.
- Chaves 17mm, 19mm e 21mm.



PARA AUTOMÓVEL

1/2"

- Alcance: 1:18.
- Par máx. saída: 360Nm.
- Par máx. torção: 800Nm.



## KIT DE 8 CHAVES 1" DESMULTIPLICADOR DE FORÇA

52056

66,00€

5,45	-	4	128
Kg	sub	if	

22, 24, 27, 30, 32, 33, 38, 41mm

CrV

1"

8 PCS



### REPOSIÇÕES DISPONÍVEI

REF.	DESCRIÇÃO	Kg	if	€
10672	32mm	0,58	1	9,50€
10673	33mm	0,58	1	9,50€
10674	27mm	0,54	1	9,50€
10675	30mm	0,54	1	9,50€

# KIT CENTRADOR DE EMBREAGEM SAC

**53001** 242,00€

905	-	1	40

- A ferramenta especial de pré-carga da embreagem, impede que o anel de aperto rode no prato de pressão da embreagem.
- A não utilização da ferramenta especial pode provocar danos no prato de pressão da embreagem e provocar um falho do conjunto da embreagem.
- Adequado para quase todas as embreagens SAC (auto-ajustáveis).

- Vantagens: Tensado da placa de pressão do embreagem em o montagem e desmontagem. Reposição mola de ajuste com a ferramenta de reinicialização. Centralização da válvula com respeito ao rolamento guia.

- Conteúdo: Tensor de Embreagem. Centralizador de 3 braços. Ferramenta para repor parâmetros de origem. Jogo de pinos centralizadores. Centralizador de 4 braços.



**PARA:**  
VW  
Audi  
Bmw  
Mercedes  
Volvo  
Renault  
Opel

# CENTRALIZADOR DE EMBREAGEM SAC

**53410** 92,00€

1.60	-	5	230



- Diâmetro centradores: 15-19 / 20-26,6 / 23-36mm
- Diâmetro acessórios: 12, 14, 15, 16, 17, 18, 19, 20mm



# KIT DE REPARAÇÃO DO EMBREAGEM DUPLA FACE PARA LA TRANSMISSÃO DSG DE VAG

**53057** 149,00€

5.55	-	2	120

- Para serviço em câmbios DSG em Golf (2004-), Golf Plus (2005-), AUDI A3 (2004-) com transmissão de 7 velocidades código 0AM, e em Touareg (2003-) com transmissão de 6 velocidades código 08D.
- Referências OEM dos úteis T10323, T10373, T10374.



# JOGO DE CHAVES DE CAIXA ESPECIAL PARA AUTOMÓVEL DE 10 PCS

**53669** 45,00€

0.70	5	20	1080



TOYOTA, NISSAN, RENAULT, OPEL ASTRA G/ZAFIRA, SMART, CITROËN, PEUGEOT, HONDA CIVIC

## CONTÉM

	<b>10S</b>	para engrenagem intermédia Toyota		<b>14 mm</b>	para pinços de freio Opel Astra G, Opel Zafira e Smart
	<b>6S</b>	para embreagens, cabeça do bloco de cilindros e eixo de equilíbrio Nissan e Renault		<b>10 mm</b>	para sistema de freio e bomba de combustível Nissan
	<b>8S</b>	para embreagens, cabeça do bloco de cilindros e eixo de equilíbrio Nissan e Renault		<b>12.5 mm</b>	para sistema de freio e bomba de combustível Nissan
	<b>12S</b>	para embreagens, cabeça do bloco de cilindros e eixo de equilíbrio Nissan e Renault		<b>19 mm</b>	para pinços de freio Peugeot, Renault e Citroën
	<b>8TS</b>	para eixo balanceador Nissan		<b>20 mm</b>	para braço de controle inferior Honda Civic



# CENTRALIZADOR EMBREAGENS UNIVERSAL PLÁSTICO

**52495** 14,50€

0.25	4	48	384



- Centralizador de embreagem útil para maioria dos modelos do mercado.
- Inclui 3 adaptadores de diferentes diâmetros.

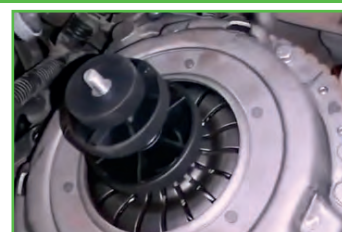



# SET DE COMPROVAÇÃO, ENCHIMENTO E Esvaziamento DE SISTEMA AACC

**53456** 98,00€

BAR

2,90	-	5	75
Kg	Sub	ff	

- Tente variações sobre os lados dos sistemas de alta e baixa pressão de ar condicionado do veículo.

- Blocos de alumínio leve com vista vidro e alta antivibrático legível.

- Acopladores de serviços profissionais (codificados por cores e rotulados).

- Três mangueiras de carregamento, codificados por cores e um gancho de suspensão para permitir o uso de mãos-livres.

- Aplicação: R134a, R12.

- Comprimento da mangueira: 1550mm.

- Alta pressão: 0-34 BAR.

- Pressão baixa: 0-24 BAR.



**ACOPLADOR DE REMOÇÃO RÁPIDA DE ALTA PRESSÃO (REF. 53456)**

**14300** 19,00€

0,20	100
Kg	ff

R-134a

**ACOPLADOR DE REMOÇÃO RÁPIDA DE BAIXA PRESSÃO (REF. 53456)**

**14301** 19,00€

0,20	100
Kg	ff

R-134a

## ADAPTADOR PARA CARGA DE GÁS 1234YF

ALTA

**53499** 29,00€

0,30	15	60	2400
Kg	Sub	ff	



Adaptador de ar condicionado / refrigerante de conexão rápida R1234YF. Vermelho (alta pressão). O desenho de conexão rápida permite segurança completa.

Com conexão que protege contra ferimentos e perda de refrigerante se desconectada sob pressão.

Uso: AACC e refrigerante

Material: latão e metal

Cor: vermelho, azul  
Tamanho: Altura 55 mm, diâmetro 30 mm

BAIXA

**53500** 29,00€

0,20	15	60	2400
Kg	Sub	ff	



## CONJUNTO DE VÁLVULAS PARA O AR CONDICIONADO

**53599** 30,30€

0,16	10	100	-
Kg	Sub	ff	



**134**  
PCS

R12 5mm L: 19mm	R12 6mm L: 19mm	R134A 7mm L: 20mm
R12 5mm L: 19mm	R12 6mm L: 22mm	R12 8mm L: 22mm
R12 5mm L: 19mm	R12 6mm L: 26.5mm	R12 9mm L: 22mm



### REPOSIÇÕES DISPONÍVEL

REF.	MEDIDA	Kg	ff	€/u.
14594	5x19mm R12 (VERDE)	0,01	10	2,00€
14595	5x19mm	0,01	10	1,50€
14596	5x19mm R12	0,01	10	2,00€
14597	6x19mm	0,01	10	7,60€
14598	6x26.5mm	0,01	10	17,80€
14599	7x20mm R134A	0,01	10	4,50€
14600	6x22mm	0,01	10	9,50€
14601	8x22mm	0,01	10	11,00€
14602	9x22mm	0,01	10	11,00€

## CAIXA DE O'RINGS PARA AA/CC

**50807** 38,00€

0,16	6	24	672
Kg	Sub	ff	



HNBR **270**  
PCS

5.29x1.78mm 20 PCS	6.07x1.78mm 20 PCS	6.8x1.9mm 20 PCS	7.65x1.78mm 20 PCS	7.80x1.90mm 20 PCS	8.0x2.0mm 20 PCS
8.80x1.90mm 20 PCS	10.82x1.78mm 15 PCS	10.77x2.62mm 15 PCS	11.0x2.0mm 15 PCS	12.0x2.0mm 15 PCS	13.9x1.80mm 10 PCS
13.95x2.62mm 10 PCS	14.0x2.0mm 10 PCS	15.0x2.0mm 10 PCS	17.0x2.00mm 10 PCS	17.17x1.78mm 10 PCS	17.04x3.53mm 10 PCS

## KIT PARA A DESCONEXÃO DO AR CONDICIONADO

**53459** 66,00€

1,05	-	10	150
Kg	Sub	ff	



8mm (5/16"),  
9,5mm (3/8"),  
13mm (1/2"),  
16mm (5/8"),  
19mm (3/4"),  
22mm (7/8")



9,5 mm (3/8"),  
16mm (5/8"),  
13mm (1/2"),  
19mm (3/4")

## KIT DETECÇÃO FUGA AA/CC

**53539** 78,00€

1.42	-	5	150
Kg	sub	ff	ff



- Conjunto especialmente concebido para detectar perdas de pressão de ar condicionado e sistemas de refrigeração com facilidade.  
- Consiste na inserção de um líquido neutro fluorescente no circuito para detectar a fuga rapidamente.

- Contém:  
1 x lâmpada UV 100Lm.  
1 x óculos de visão UV.  
1 x seringa inserção líquido.  
1 x adaptador rápido.  
1 x adaptador de extensão.  
1 x pila recarregável.  
1 x carregador.

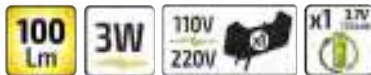

LÍQUIDO DETECÇÃO FUGA SISTEMA AA/CC



**12977** 36,50€

0.33	3	12	480
Kg	sub	ff	ff

250ml

- Uma aplicação de 7,5 ml para 1.4L de refrigerante.

ÓCULOS UV (REF.53539)

**14187** 6,00€

0.05	10	120	1080
Kg	sub	ff	ff

BATERIA PARA 53539

**15052** 3,00€

0.05	5	10
Kg	sub	ff

SERINGA DETECÇÃO DE VAZAMENTO AA/CC

**12200** 14,50€

1.10	50
Kg	ff

LANTERNA PARA 53539

**15054** 34,00€

0.12	5	10
Kg	sub	ff

CARREGADOR PARA 53539

**15053** 10,50€

0.08	10
Kg	ff

## LÂMPADA PORTÁTIL COB ULTRAVIOLETA FLEXÍVEL COM BASE MAGNÉTICA

**53530** 46,00€

0.35	-	20	620
Kg	sub	ff	ff

380mm 45mm

LUZ ULTRAVIOLETA

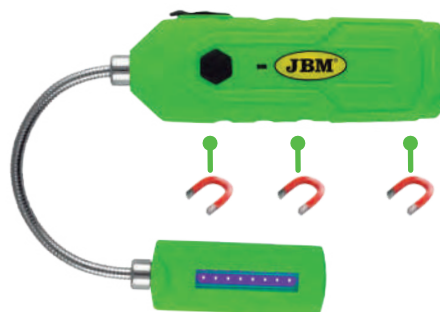

UV



## COMPROVADOR DE VAZAMENTO DE PRESSÃO PARA SISTEMA DE REFRIGERAÇÃO

**52687** 168,00€

6.70	-	1	24
Kg	sub	ff	ff

- Alcance de comprovação 0 -2,5 bar.  
- 19 cabeçiais de comprovação de radiadores específicos.  
- 1 cabeçal de comprovação de radiadores universais.



1: Bomba de pressão com válvula de descarga.  
2A: conector 1: acoplador para os cabeçiais No.3(R123) e No.4 (R124); 2B: conector 2: acoplador para os cabeçiais No. 3(R123) y No. 5(R125)  
3: Mercedes (W123, W126, W124, W201), GM(Buick), Jeep  
4: Peugeot, Subaru, Chrysler, Acura, GM (Nova, Spectrum, Sprint), Mitsubishi, Nissan, Mazda, Toyota, Infiniti, GEO, Suzuki, Isuzu, Mercedes  
5: Honda, Toyota, Suzuki, Mitsubishi, Chrysler, Acura  
6: Mercedes Benz (ML, W163, W164), GM (Acliva, Skylark, Grand Am 1992-2002)  
7: Volvo, Saab, Sterling, Citroen, Renault, Fiat, Alfa, Jeep  
8: VW(Vento, T4, Passat-1996, Golf, Beetle, Sharan)  
9: Audi(A4, A5, A6), BMW 345, VW(Pas-

sat- 1997-2002), Porsche(Cayenne)  
10: BMW (E46, E36, E34, E39, E38, E32, E90).  
11: Audi, VW.  
12: Internacional, Land Rover, Jaguar.  
13: Mercedes.  
14: Ford Focus.  
15: Mazda(M3).  
16: Mercedes classe A (W168).  
17: BMW E60, E63, E64, E65.  
18: VW SHARAN 1.8T 2.8.  
19: TOYOTA-RAV4, PREVIA Adaptador universal de goma para purga e enchimento adores.  
20: SAAB.  
21: LAND ROVER.



# JOGO DE ENCHIMENTO DE ÓLEO COM FUNIL E ADAPTADORES

**53485** 140,00€

3,00	-	4	40
Kg	Sub	ff	Tr

**15**  
PCS

**53347** 100,00€

2,75	-	4	36
Kg	Sub	ff	Tr

**8**  
PCS

Conteúdos:

- 1- Adaptador roscado M42 x 4.5 para Subaru
- 2- Adaptador roscado M37 x 3.0 (tipo curto) para Lotus, Pontiac, Scion, Toyota
- 3- Adaptador roscado M35 x 4.0 para Ford, Jaguar, Land Rover, Mazda
- 4- Adaptador roscado M32 x 3.5 para Acura, Dodge, Ford, Honda, Jaguar, Jeep, Land Rover, Mazda, Nissan
- 5- Adaptador baioneta para Toyota & Lexus 3.0 & 3.3L V6
- 6- Adaptador baioneta para Audi, BMW, Mercedes-Benz, Porsche, Volvo, VW
- 7- Adaptador roscado M30 x 3.0 para Dodge Cummins
- 8- Adaptador roscado (1/2 volta) para Mazda 3 / 6 / CX-5
- 9- Adaptador roscado (1/2 volta) para Cadillac, Chevy, Ford, GMC, Hyundai, Jaguar, Land Rover, Mazda, Saab, Mercury
- 10- Adaptador roscado (1/4 volta) para novas tampas de óleo desde 2008 para Audi, Seat, Skoda, VW com motor EA888
- 11- Adaptador roscado (1/2 volta) para Dodge Hemi 6.4L (2011-) > 3.6L (>2014)
- 12- Adaptador roscado M37 x 3.0 (tipo longo) para Lotus, Pontiac, Scion, Toyota



Conteúdos:

- 1- Adaptador roscado M42 x 4.5 para Subaru
- 2- Adaptador roscado M37 x 3.0 (tipo curto) para Lotus, Pontiac, Scion, Toyota
- 3- Adaptador roscado M35 x 4.0 para Ford, Jaguar, Land Rover, Mazda
- 4- Adaptador roscado M32 x 3.5 para Acura, Dodge, Ford, Honda, Jaguar, Jeep, Land Rover, Mazda, Nissan
- 5- Adaptador baioneta para Toyota & Lexus 3.0 & 3.3l V6
- 6- Adaptador baioneta para Audi, BMW, Dodge, Mercedes-Benz, Porsche, Volvo, VW

## BOMBA DE COMPROVAÇÃO DE PRESSÃO

**54016** 76,00€

1,50	-	5	100
Kg	Sub	ff	Tr

Juntamente com a bomba de vácuo, o kit inclui um conjunto de bicos, adaptadores, plugues, juntas de borracha e medidores para sangrar e verificar o sistema de freio de maneira adequada e fácil.

Pressão máxima:  
40 psi (3 bar)  
Pressão mínima:  
-20 psi (-0,75 bar)



**MAX**  
40 PSI  
3 bar

**MIN**  
-20 PSI  
-0,75 bar

## COMPROVADOR DE FUGA PARA JUNTAS DE CILINDROS

**53662** 89,00€

1,78	5	10	80
Kg	Sub	ff	Tr

- Esta ferramenta foi projetada para verificar vazamentos entre a combustão e o sistema de resfriamento de motores refrigerados a água.
- O processo de combustão produz (entre outros gases) 13-14% de CO2 no escape, e vazamentos desse gás no sistema de refrigeração são facilmente detectáveis.
- Se houver gases de combustão, o cor do fluido de teste mudará para amarelo ou verde e isso será uma prova do vazamento de CO2 no refrigerante.
- O fluido de teste NÃO pode ser reutilizado.

- Contém:  
Garrafa redonda de 200ml.  
Garrafa quadrada de 250 ml.  
Adaptadores:  
Pequeno: Suzuki, Toyota, Mitsubishi.  
Médio: Suzuki, Toyota, Mitsubishi, Subaru, Peugeot, Nissan, Lexus, Mazda.  
Grande: Ford, GM, Benz, JEEP.



**FLUIDO DE TESTE DE FUGAS DE COMBUSTÃO**

**14563**  
18,00€

0,23	5	50
Kg	Sub	ff



## CONJUNTO DE 6 CHAVES 1/2" TIPO E EXTRA LONGA

53915 65,00€

CABEÇA COM ESCURECIMENTO

2.10	-	10	240
Kg	sub	ff	ff

**E12** Socket for BMW cylinder head:  
- M42 engine, 1.8L, 4 cylinders, 16V, model 318 is from 1989  
- M50 engine, 2.0L, 2.5L, 6 cylinders, 24V, model 520i, 525i from 1991



CINCADO



1/2"

6 PCS

CrV

## GRAMPO DE MOLA DE VÁLVULAS

52693 24,50€

0.65	5	20	450
Kg	sub	ff	ff



- Válido para os motores OHV, OHC, CHV.  
- Permite o reemplazo das molhas e sellos de válvulas com a cabeça del cilindro montada.  
- Capacidade para comprimir u extraer.  
- Com grampo / adaptador reversible e bloqueio da posição predeterminada.

## GRAMPO DE VÁLVULAS

51120 41,00€

2.10	-	5	160
Kg	sub	ff	ff

- Apto para carros e motas.  
- Os 5 adaptadores permitem um encaixe correcto e fácil para comprimir a mola da válvula.



- Compressor de Molhas.  
- Adaptador de: 30, 25, 23, 19, 16mm.

## GRAMPO DE MOLA DE VÁLVULAS 45-145MM

52734 51,00€

2.61	-	5	175
Kg	sub	ff	ff



## 2PCS FERRAMENTA PARA RODAR VÁLVULAS

52850 7,80€

0.11	6	72	1008
Kg	sub	ff	ff

Ø 3,49-2,86mm  
Ø 1,59-2,06mm

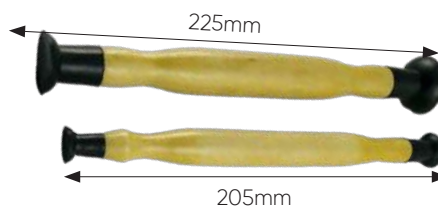

## ORGANIZADOR PARA COMPONENTES DO MOTOR

53637 85,00€

1.40	-	5	20
Kg	sub	ff	ff

260mm 400mm 450mm

- Especial para peças de cabeçotes.  
- Mantém todos os componentes limpos e arrumados à medida que são removidos da cabeça do cilindro.  
- Economize tempo. Isso facilita o seu trabalho.



## FERRAMENTA PNEUMÁTICA POLIMENTO VÁLVULAS - PERCUSSÃO E ROTAÇÃO

53572 348,00€

1.90	-	5	80
Kg	sub	ff	ff

- Conteúdo:  
1 x máquina pneumática para válvulas.  
5 x ventosa (16, 20, 30, 35 e 45 mm).  
5 x adaptador de válvula.  
Chave Allen de 1 x 3 mm.



REGULA A VELOCIDADE

50

16mm

20mm

30mm

35mm

40mm

14157

8,30€

14158

9,95€

14159

12,60€

14160

12,80€

14161

13,70€

VIRAR À DIREITA +  
VIRAR À ESQUERDA



## KIT DE FERRAMENTAS PARA AROS DE PISTÃO

53251 88,00€

2.80	-	4	72
Kg	sub	ff	ff



- Conjunto completo de aros e anéis de pistão.  
- Pinça ou alicata para instalar segmentos de pistões.  
- O aperto dos cintos tem um sistema de roquete dentado.

H:3"  
Ø 53-125mm

H:4"  
Ø 60-175mm

H:6"  
Ø 60-175mm

## COMPRESSOR AROS PISTÃO

52697 16,00€

0.50	5	40	720
Kg	sub	ff	ff

Ø 60-175mm

6"

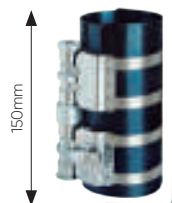

52696 12,00€

0.28	5	40	1200
Kg	sub	ff	ff

Ø 53-175mm

3"

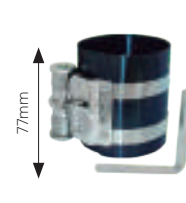



## POLIDORA DE CILINDROS

### 2 BRAÇOS

**52591** 12,00€

0,10 12 72 1728  
Kg SUB

Ø ↑ 55mm  
↓ 19mm

28,6mm

1-1/8"



### 3 BRAÇOS

**52592** 22,00€

0,20 - 20 480  
Kg SUB

Ø ↑ 85mm  
↓ 35mm

50,8mm

2"

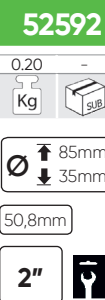

**52593** 34,00€

0,47 6 36 360  
Kg SUB

Ø ↑ 170mm  
↓ 55mm

101,6mm

4"



PASTILHA DE POLIR 1 - 1/8"  
EM BLISTER DE 2 UNIDADES  
PARA REF. 52591

**11878** 4,10€

0,10 25 100  
Kg SUB



PASTILHA DE POLIR 2"  
EM BLISTER DE 3 UNIDADES  
PARA REF. 52592

**11879** 5,10€

0,04 25 100  
Kg SUB



PASTILHA DE POLIR 4"  
EM BLISTER DE 3 UNIDADES  
PARA REF. 52593

**11880** 10,50€

0,09 25 100  
Kg SUB



## COMPRESSOR DE MOLAS

**53394** 598,00€

29,70 - 1 18  
Kg SUB



- Kit profissional que permite remover e instalar rapidamente as molas da suspensão dianteira e traseira sem desmontar o eixo.

- Braço telescópico e superfícies antiderrapantes que permitem um aperto sólido das molas.
- Garras equipadas com uma proteção de plástico intercambiável para evitar danificar a pintura da mola.
- Impede que as molas se dobrem na compressão.
- Universal, cobre 90% da frota de veículos.
- Pode ser usado tanto para molas retas como cónicas.

- Conteúdo:  
Dispositivo / pistão.  
Três pares de grampos  
com tampas de plástico.

300 mm

2 x 68-123MM  
2 x 68-160MM  
2 x 118-212MM

36.000 Nm  
1.050 Kg

Adequado para uso com ferramentas pneumáticas



## KIT PARA REMOÇÃO DE AMORTECEDOR

**53118** 231,00€

6,66 - 2 44  
Kg SUB



CRV 6140  
CRMO  
SCM415  
CRV 50BV30



39  
PCS



## COMPRESSOR MOLAS PARA AMORTECEDORES

**50827** 387,00€

32,90 - 1 15  
Kg SUB



- Capacidade: 1T (2200 lbs)
- Diâmetro da mola comprimida: 200mm
- Comprimento de compressão: 200-500mm

1T

200-500mm

830mm

350mm

190mm



## COMPRESSOR DE MOLAS PROFESSIONAL McPHERSON

**52227** 247,00€

15,10 - 1 36  
Kg SUB



- Especificações  
Carga máxima: 2500N.  
Um corpo principal.  
Um suporte estendido.  
3 pares de mandíbulas.

- Par 1: Alcance de uso: 80-115mm. Peso: 1,45kg.
- Par 2: Alcance de uso: 110-195mm. Peso: 2,2kg.
- Par 3: Alcance de uso: 140-195mm. Peso: 2,3kg.

- BMW, Toyota, Ford, Mitsubishi, VW, Audi, Saab, Nissan, Honda Accord, Subaru, Volvo, Opel, Porsche.

NÃO USAR COM PISTOLA NEUMÁTICA

## KIT COMPRESSOR DE MOLAS

**51121** 27,30€

1,80 - 5 420  
Kg SUB



- Garras e pernos reforçados com aleação de ferro - carbono (termo-tratados).
- Indicada para usar em espaços limitados e baixo o arco da roda.
- Abertura máxima: 250mm.

270mm

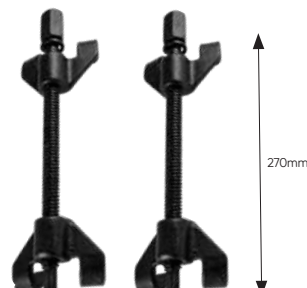

## PISTOLA ESTROBOSCÓPICA

- Ajuste de ignição de motores.

DIGITAL

**53474** 94,00€

0,85 5 20 160

Kg SUB ITT

12V 1.8m 0,1° 9.000

3,6W

**53240** 58,00€

0,75 - 20 160

Kg SUB ITT

12V 1.5m

3,6W



2 PINÇAS



SENSOR INDUTIVO



2 PINÇAS



SENSOR INDUTIVO

## ESTETOSCÓPIO ELECTRÔNICO

**53249** 192,00€

2,65 - 5 40

Kg SUB ITT

- Kit adequado para detecção de falhas em coletores de admissão/escape, INJETORES, radiadores, etc.
- Permite a auscultação de diversos pontos do veículo de forma simultânea facilitando o trabalho do operário na hora de encontrar e diagnosticar avarias.
- Sondas marcadas por cor que facilitam o trabalho do operário.
- Inclui velcro de fixação para os sensores.

- Características
- Comprimento do cabo sensor: 4,8 m
- Comprimentos da sonda de áudio: 14 cm
- Baterias de 9V (incluída)
- Quantidade de sensores: 6
- Adequado para conector de 3,5 mm
- Comprimento ajustável do microfone: 21 cm



## ESTETOSCÓPIO

**51347** 9,90€

0,14 5 50 400

Kg SUB ITT

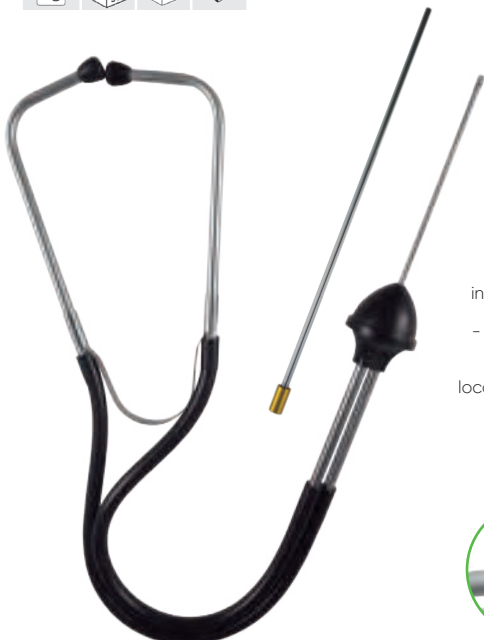
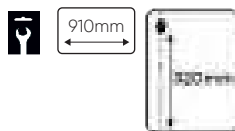

- Aumenta e localiza ruídos internos mecânicos e de passagem de fluidos.
- Localiza a fonte de ruído do motor rapidamente.
- Escuta os problemas de localização de fluidos de água, petróleo, gás ou vapor.
- Ponta à prova de golpes.



Ø 12mm

## FERRAMENTA DE DESMONTAGEM DE CONECTORES

**53663** 8,00€

0,01 10 100 4800

Kg SUB ITT

VAG



- Ferramenta para desmontar conectores em veículos do grupo VAG sem danificá-los.



## CONJUNTO DE FERRAMENTAS PARA AJUSTAR FARÓIS

**53729** 19,10€

0,40	10	40	480
Kg	Sub	ft	ft



## GRAMPO PARA ABRIDORES DO CAPO E PORTA-MALAS

**53525** 12,00€

0,10	5	30	1770
Kg	Sub	ft	ft



## CABO EXTENSÍVEL MULTIFUNÇÃO

**52497** 26,80€

0,29	6	48	480
Kg	Sub	ft	ft

↑120mm  
↓53mm

**53196** 33,00€

0,37	6	48	-
Kg	Sub	ft	ft

↑160mm  
↓71mm

- Para comprobar o funcionamento correcto das luzes de travão: esticando o cabo, um extremo pressionando o pedal do travão e o outro no volante.
- Para determinar a pressão dos pneumáticos.
- Para eliminar pequenas pedras ou cravos nas ranhuras dos pneumáticos.
- Para levantar o capô convenientemente e comprobar o óleo do motor, bateria, correia, radiator, etc.

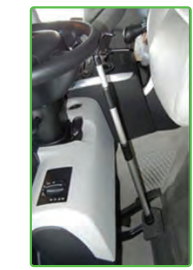

## CHAVE PARA MAÇANETAS VAG

**53655** 12,00€

0,09	12	96	1152
Kg	Sub	ft	ft



## PORTAPUNTAS ANGULAR

**52620** 8,80€

0,05	6	36	1584
Kg	Sub	ft	ft



## JOGO DE 8 PINÇAS PARA A DESCONEXÃO DE MANGUEIRAS

**53477** 36,10€

0,80	-	10	220
Kg	Sub	ft	ft

8 PCS

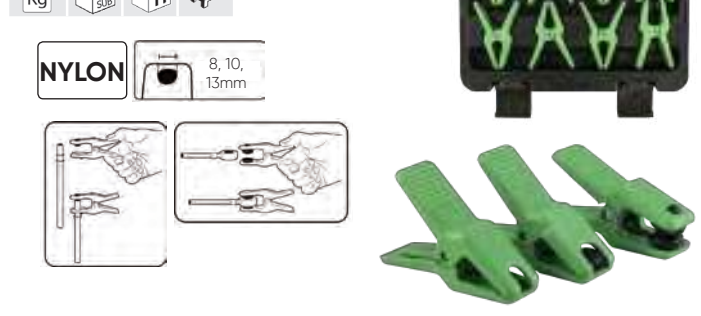

## KIT DE ALICATES PARA MANGUEIRAS FLEXÍVEIS

3 PCS NYLON

1/2" 3/4" 5/8"

**52066** 12,00€

0,28	5	40	480
Kg	Sub	ft	ft

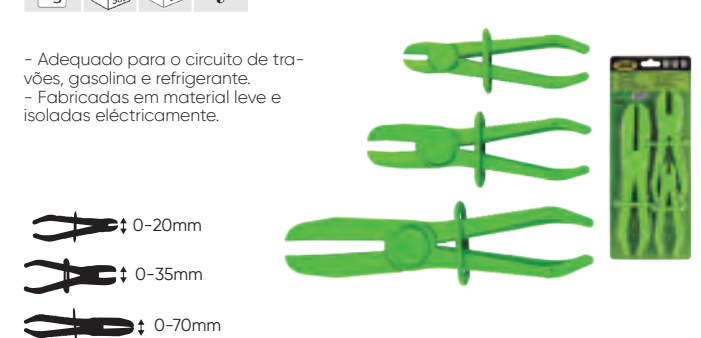

**53395** 16,00€

0,30	5	20	360
Kg	Sub	ft	ft



# CONJUNTO DE 3 BANDEJAS DE FERRAMENTAS ELÁSTICAS ANTI DERRAPANTE

**53903** 59,00€

1,65	-	10	100

- Materiale antiscivolo.
- Ideale per tutti condizioni operative, offre un accesso facile e comodo agli strumenti.
- Maniglia incorporata, portatile e comoda.
- Resistente all'olio.
- Resistente alle temperature fino a 140°C.
- Righele incorporato su entrambi i lati del vassoio.

- Scomparti separati per una corretta organizzazione degli utensili.
- Ventosa dal design unico per un fissaggio sicuro su superfici piane.



## VASSOIO PICCOLO

**15010** 16,50€

0,40	20	360

## VASSOIO MEDIO

**15011** 18,00€

0,45	20	320

## VASCHETTA GRANDE

**15012** 31,50€

1,05	10	120

- Piccolo: 285 x 137 x 27 mm
- Medio: 285 x 202 x 27 mm
- Grande: 543 x 300 x 27 mm
- Materiale: gomma morbida

## RECIPIENTE MAGNÉTICO FLEXÍVEL

- Prato de plástico flexível magnético para aguentar parafusos, parafusos e peças pequenas.

**52516** 28,00€

0,42	6	24	1152

- Ø superior: 225mm.
- Ø base: 88mm.
- Medidas implementadas: 135mm.
- Medidas dobráveis: 43mm.

**52517** 6,00€

0,10	12	72	1152

- Ø superior: 135mm.
- Ø base: 53mm.
- Medidas implementadas: 90mm.
- Medidas dobráveis: 31mm.



## RECIPIENTE MAGNÉTICA

**52466** 11,00€

0,43	-	20	180

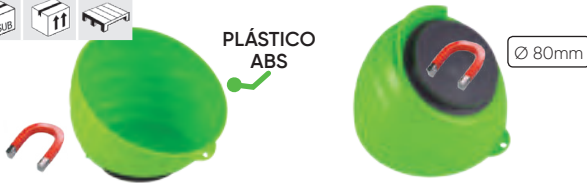

Ø 150mm  
112mm  
Ø 80mm

## RECIPIENTE MAGNÉTICO

**50787** 8,00€

0,35	6	36	648



x1 Ø 150mm

**50788** 14,50€

0,62	6	24	432



x1 239 x 139mm

## SUPORE PARA FERRAMENTAS MAGNÉTICO

**52467** 10,30€

0,50	-	24	1008

- Imán de grande alcance almofadado para evitar estragar as superficies.

40mm  
145mm  
75mm



## GANCHO MAGNÉTICO

**52378** 10,00€

0,36	10	40	720

3KG Ø 60mm



**51341** 35,00€

1,62	-	12	96

9KG Ø 70mm



## KIT 2 ESTANTES MAGNÉTICAS

**50790** 29,00€

1,17	-	12	96

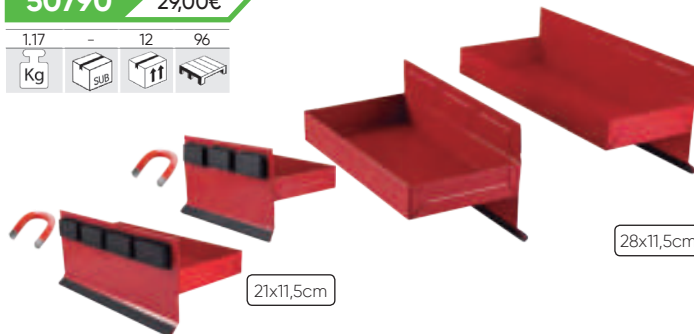

21x11,5cm

28x11,5cm

## BARRA MAGNÉTICA PARA FERRAMENTAS

**50789** 29,00€

0,89	10	20	500

600mm



## CONJUNTO DE 5 ÍMÃS

**53958** 6,50€

0,05	10	100	-

Ø 15mm



NEODYMIUM RECUBRIDO  
5 PCS



## RECÂMBIO DE GAS

51986 11,90€

0,18	-	24	1584
Kg	SUB	ff	ff

200ml



## MAÇARICO

51920 18,00€

0,14	10	100	400
Kg	SUB	ff	ff

- Gás não incluído.



## EXTRATOR DE ABRAÇADEIRAS HENN

53696 22,00€

0,10	6	96	1536
Kg	SUB	ff	ff

- Volkswagen, Audi, Seat, Škoda, BMW, Peugeot, Citroën, Dacia, Fiat, Ford, Kia, Lexus, Mazda, Mercedes, Nissan, Opel/Vauxhall, Porsche, Renault, Toyota, Volvo.

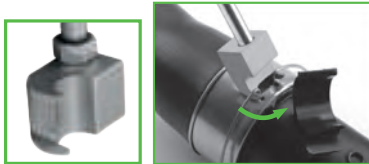

## CORTADOR E REBITADOR DE CORRENTE MOTOCICLETAS

53055 33,00€

0,89	5	10	480
Kg	SUB	ff	ff



## CORTADOR DE CORRENTE DE MOTOCICLETA

53665 19,00€

0,35	10	60	1920
Kg	SUB	ff	ff

25-60



53666 28,00€

0,70	5	30	1920
Kg	SUB	ff	ff

60-100



## LIMPADOR DE TERMINAIS DE BATERIA

52319 8,80€

0,18	12	48	720
Kg	SUB	ff	ff



52621 11,00€

0,14	10	40	960
Kg	SUB	ff	ff



x2

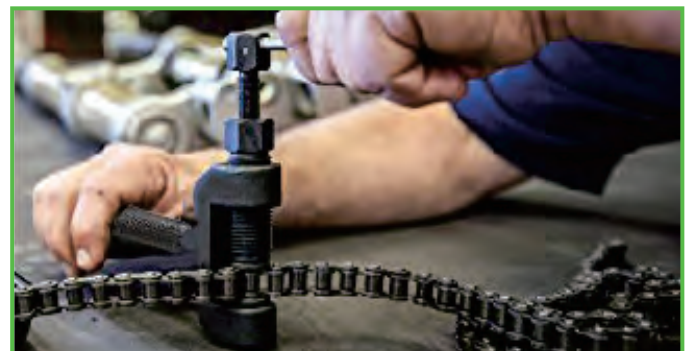

## KIT 38 ESCOVAS DE LIMPIEZA METAL / PLÁSTICO

**51989** 49,00€

1,64	-	10	120
Kg	sub	ff	ff



Ø 8, 9, 10, 11, 12, 13, 14,  
15, 16, 17, 18, 19mm

**38**  
PCS

- 1 Cabo de 1/4".
- 1 Alargador.
- 36 escovas.



## ESCOVAS METÁLICAS

**52760** 4,10€

0,09	6	120	2160
Kg	sub	ff	ff



**52515** 9,10€

0,14	6	72	800
Kg	sub	ff	ff

- 1 x latão.
- 1 x nylon.
- 1 x aço.



225mm

**3**  
PCS

## CHAVE PARA TAMPA DE AFORADORES

**53096** 28,80€

1,00	5	10	300
Kg	sub	ff	ff



89-170mm

15mm



## EXTRATOR UNIVERSAL DE AFORADORES

**52757** 16,00€

0,55	5	20	480
Kg	sub	ff	ff

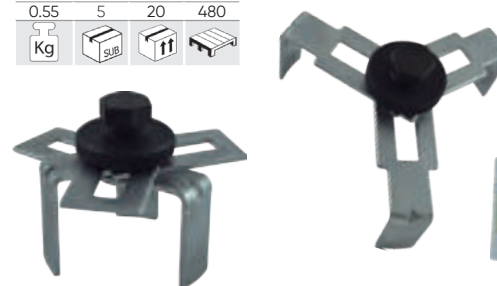

160mm  
75mm



## CHAVE ESPECIAL PARA MOTAS

**53054** 6,00€

0,16	12	72	1500
Kg	sub	ff	ff



19, 22, 24mm



## CHAVE PARA MOTAS

**53086** 9,00€

0,18	12	72	1500
Kg	sub	ff	ff

Yamaha, Kawasaki,  
BMW, Suzuki, Honda



17, 19, 22, 24mm

**3/8"**







## **KIT DE BLOQUEIO**

- |     |   |
|-----|---|
| 218 | BMW   |
| 222 | MERCEDES  |
| 224 | VAG   |
| 229 | RENAULT / NISSAN                                    |
| 231 | FORD / MAZDA  |
| 233 | JAGUAR / LAND ROVER                                 |
| 234 | OPEL / VAUXHALL                                     |
| 238 | CITROËN / PEUGEOT                                   |
| 242 | VÁRIOS  |
| 244 | GABINETE COM FERRAMENTAS DE AJUSTE DE SINCRONIZAÇÃO |
| 245 |   |

## KIT DE BLOQUEIO BMW N42 / N46 1.8 / 2.0 CADEIA

53259 97,00€

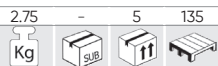

GASOLINA/PETROL

### MARCAS

BMW 1 SERIES: 118i E81/82/87/88 (04-14), 120i E81/82/87/88 (04-14).  
 BMW 3 SERIES: 316i/ti Compact E46 (01-07), 318i/ti Compact E46 (01-07), 318i, E90/91/92/93 (05-12), 320i E90/91/92/93 (05-12).  
 BMW 5 SERIES: 520i E60/61 (07-10), Z4 2.0 E85/86 (04-09).  
 BMW X SERIES: X1 sDrive 18i E84 (10-12), X1 xDrive 18i E84 (10-12), X3 2.0 E83 (05-10).

### FERRAMENTAS OEM

119350 (1), 119340 (2), 119291 (3), 119292 (4), 119270 (5), 115120 (6), 119190 (7), 119293 (8)

### CÓDIGOS DE MOTOR

1.8: N42; B18A, N46; B18. / 2.0: N42; B20A, N46; B20, B20B, N46T; B20, B20B, B20BD, B20BZ, B20O2, B2O2.

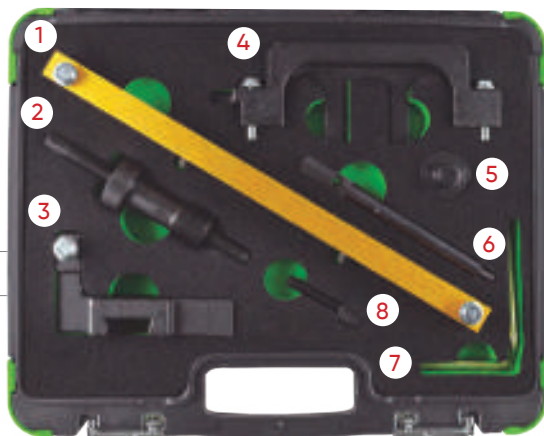

## KIT DE BLOQUEIO BMW N43 1.6 / 2.0 CADEIA

53260 168,00€



GASOLINA/PETROL

### MARCAS

BMW

BMW 1 SERIES: 116i E81/82/87/88 (07-12), 118i E81/82/87/88 (06-14), 120i E81/82/87/88 (06-14).  
 BMW 3 SERIES: 316i/ti Compact E46 (01-07), 318i E90/91/92/93 (07-11), 318i E90/91/92/93 (07-13), 320i E90/91/92/93 (07-14).  
 BMW 5 SERIES: 520i E60/61 (07-10).

### FERRAMENTAS OEM

118690 (118691/118692/118693) (1), 118710 (118711/118712) (2), 113340 (3) (4), 118700 (5), 119340 (119341/119342) (6), 115120 (7).

### CÓDIGOS DE MOTOR

1.6: N43 B16A/AA, B16AA, B16AA/OO.  
 2.0: N43 B20A, B20A/AA, B20AA, B20AY, B20KO, B20UO.

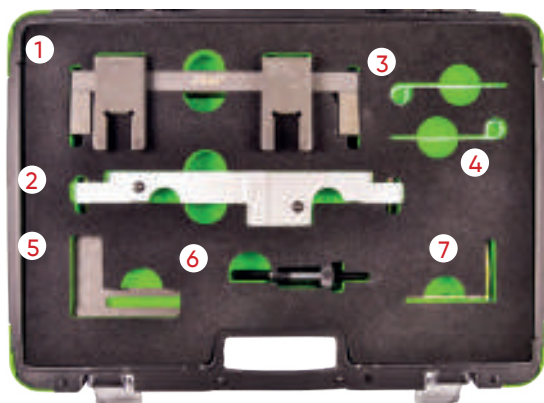

## KIT DE BLOQUEIO BMW N42 / N46

53261 214,00€

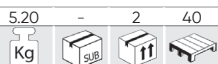

GASOLINA/PETROL

### MARCAS

BMW 1 SERIES: 118i E81/82/87/88 (04-14), 120i E81/82/87/88 (04-14).  
 BMW 3 SERIES: 316i/ti Compact E46 (01-07), 318i/ti Compact E46 (01-07), 318i E90/91/92/93 (05-12), 320i E90/91/92/93 (05-14).  
 BMW 5 SERIES: 520i E60/61 (07-10).  
 BMW X SERIES: X1 E84 sDrive 18i (10-12), X1 E84 xDrive 18i (10-12), X3 E83 2.0 (05-10).  
 BMW Z SERIES: Z4 2.0 E85/86 (04-09).

### FERRAMENTAS OEM

119190 (1), 119310 (2), 119302 (3)

### CÓDIGOS DE MOTOR

2.0: N42 B18A, N42 B20A, N46 B18, N46 B20, N46 B20B, N46T B20, N46T B20B, N46T B20BD, N46T B20BZ, N46T B20O2, N46T B2O2

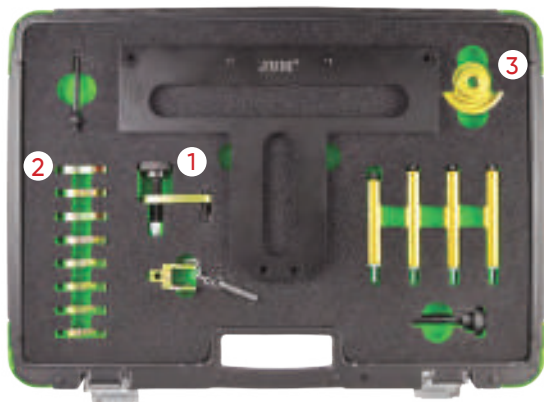

## KIT DE BLOQUEIO EIXO DE COMANDO BMW M52TU / M54 / M56 DUPLO VÃOS

53262 251,00€



GASOLINA/PETROL

### MARCAS

M52TUB25: 1997-2001 E46 323i/323Ci/323ti (M52T); 1998-2001 E39 523i (M52TU); 1998-2001 E36/7 Z3 (M52TU).  
 M52TUB28: 1997-2001 E46 328i/328Ci (M52TU); 1997-2001 E36/7 Z3 2.8 (M52B28/Z3); 1998-2001 E39 528i (M52TU); 1998-2001 E38 728i (M52TU).  
 M54B22: 2001-2003 E46 320i/320Ci; 2001-2003 E39 520i; 2001-2002 E36 Z3 2.2i; 2003-2005 E85 Z4 2.2i; 2003-2005 E60/E61 520i.  
 M54B25: 2001-2002 E36/7 Z3 2.5i; 2001-2005 E46 325i/325xi; 2001-2006 E46 325Ci; 2001-2004 E46 325ti; 2001-2004 E39 525i; 2003-2004 E60/E61 525i/525xi; 2004-2006 E83 X3 2.5i; 2004-2006 E85 Z4 2.5i.  
 M54B30: 2001-2005 E46 330i/330xi; 2001-2006 E46 330Ci; 2001-2003 E39 530i/2001-2002 E36 Z3 3.0i; 2003-2005 BMW E60 530i; 2003-2006 E85 Z4 3.0i; 2001-2006 E53 X5 3.0i.

### FERRAMENTAS OEM

116150 (1), 113450 (2), 113292 (3), 116180 (4), 114220(5)

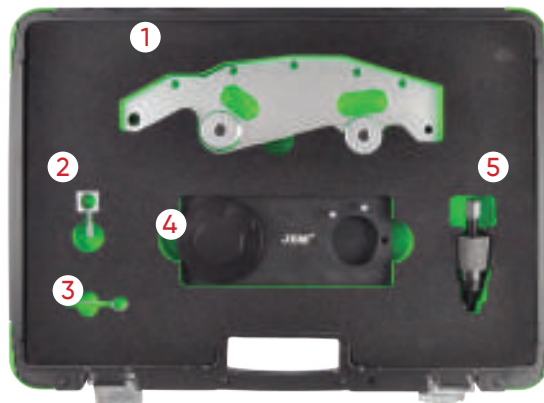



## KIT BLOQUEIO EIXO DE COMANDO BMW M47

**53263** 57,00€

180 - 5 165

Kg SUB

**DIESEL/GASOIL**

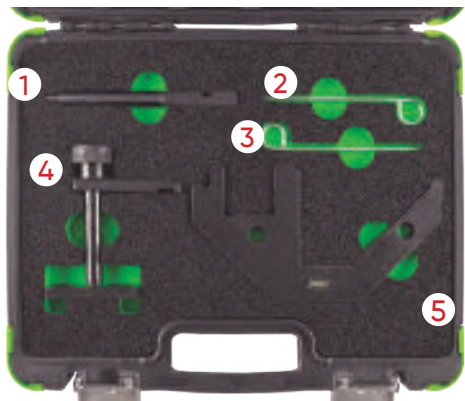

<b>MARCAS</b>	BMW BMW 1 SERIES: 118d E87 (04-07), 120d E87 (04-07). BMW 3 SERIES: 318d/td Compact E46 (01-05), 318d/td E90/91 (05-08), 320d/td Compact E46 (98-05), 320d/cd E90/91 (05-08), 325d E90/91/92/93 (02-10), 330d/cd E46/90/91/92/93 (99-07), 335d E90/91/92 (06-11). BMW 5 SERIES: 520d E39/60/61 (00-09), 525d/xd E39/60/61 (00-10), 530d/xd E46/60/61 (98-10), 535d E60/61 (04-10). BMW 6 SERIES: 635d E63/64 (07-11). BMW 7 SERIES: 730d/ld E38/65/66 (98-08). BMW X SERIES: X3 2.0d E83 (04-07), X3 3.0d/sd E83 (03-10), X5 3.0d E53/E70 (00-10), X6 3.0d E71/72 (08-10), X6 3.5d E71/72 (08-10). LAND ROVER: Freelander Td4 (00-06), Range Rover Td6 (02-06). MG/ROVER: MG-ZT/T (01-05), Rover 75 CDT/CDTi (99-05). VAUXHALL/OPEL: Omega-B (01-03).
<b>FERRAMENTAS OEM</b>	112300/12-108, 12-171/KM-813 (1), 113340/12-172/KM-823 (2) (3), 116322/12-174/KM-6267 (4) 116320 (5)
<b>CÓDIGOS DE MOTOR</b>	BMW 2.0D: M47, M47T2, M47TU / 2.5D: M57, M57T2, M57TU / 3.0D: M57, M57T2, M57TU LAND ROVER 2.0D: 204D3 (TD4) / 3.0D: 306D1 (TD6) MG/ROVER 2.0D: M47R / 2.0d CDT: M47R VAUXHALL/OPEL 2.5D: Y25DT

## KIT DE BLOQUEIO DE DISTRIBUIÇÃO PARA BMW, MINI 1.2, 1.5, 2.0, 3.0

**54228** 187,00€

5.15 - 2 48

Kg SUB

**GASOLINA/PETROL**

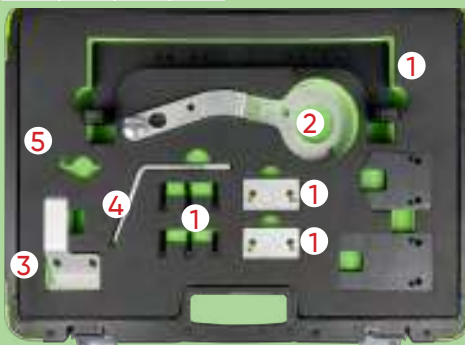

<b>MARCAS</b>	BMW: 1 Series (2015 - 2019), 2 Series (desde 2014), 3 Series (desde 2015), 4 Series (desde 2015), 5 Series (desde 2017), 6 Series (desde 2017), 7 Series (desde 2015), 8 (desde 2014), X1 (desde 2015), X2 (desde 2018), X3 (desde 2017), X4 (desde 2018) and Z4 (desde 2019); MINI: Clubman (desde 2015), Hatch (desde 2014), Convertible (desde 2016) and Countryman (desde 2017)
<b>FERRAMENTAS OEM</b>	2 358 122 (1), 2 357 904 (2), 2 365 488 (3), 2 288 380 (4), 11 4 120 (5).
<b>CÓDIGOS DE MOTOR</b>	BMW: 1,5 B38 A15A, B38 B15A, B38 K15A ,1,6 B48 B16A, 2,0 B48 A20A, B48 A20B, B48 A20E, B48 B20A, B48 B20B , 3,0 B58 B30A, B58 B30B, B58 B30C Mini 1,2 B38 A12A , 1,5 B36 A15A, B38 A15A , 2,0 B46 B20A, B48 A20A, B48 A20B

## KIT DE DISTRIBUIÇÃO PARA MINI 1.6

**54222** 59,00€

1.40 5 10 240

Kg SUB

**GASOLINA/PETROL**



<b>MARCAS</b>	BMW: Mini cooper S(07-10) Peugeot: 207(06-10), 307(06-10), THP(06-10), GTI(06-10) Citroen: DS3(06-10), C4(06-10), Grande Picasso TPH(06-10)
<b>FERRAMENTAS OEM</b>	119550(1), 119551(2), 119552(3), 119590(4)
<b>CÓDIGOS DE MOTOR</b>	N14 B16A , N14 B16CD , N14 B16TO

## KIT DE BLOQUEIO BMW DIESEL

**53265** 195,00€

5.45 - 2 40

Kg SUB

**DIESEL/GASOIL**

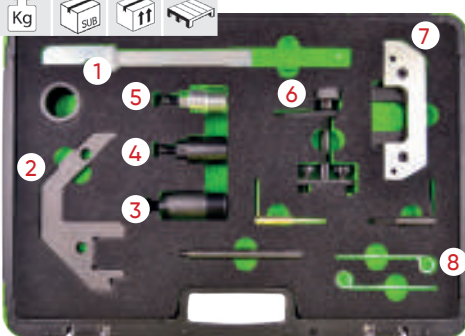

<b>MARCAS</b>	BMW
<b>FERRAMENTAS OEM</b>	113360 (1), 116321 (2), 135190 (3), 135191 (4), 135192 (5), 116322 (6), 112300 (7), 113340 (8)
<b>CÓDIGOS DE MOTOR</b>	M41 / M51 / M47TU / M47TU T2. M57TU T2 3.01 1998 - 2008.

# KIT DE BLOQUEIO BMW M42 / 44 / 50 / 52 / 54 / 56

53267

277,00€

GASOLINA/PETROL

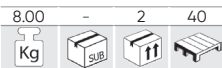

MARCAS

BMW SERIES: 3, 5, 7, X, Z

FERRAMENTAS OEM

114220 (1), 112300 (2), 113240 (3), 115490 (4), 113292 (5), 113450 (6)

CÓDIGOS DE MOTOR

M40, M44, M50, M52, M54, M56.

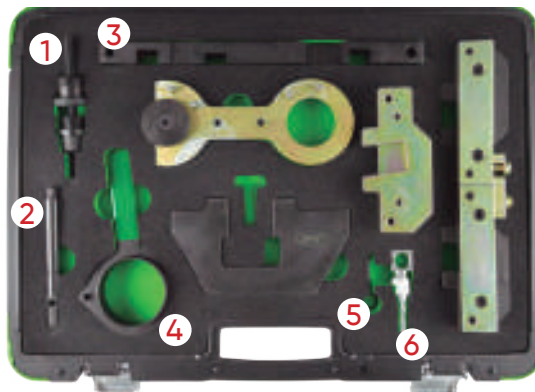

# KIT DE BLOQUEIO BMW N62 / N73

53264

143,00€

GASOLINA/PETROL

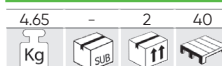

MARCAS

BMW 5 SERIES: 540i E60/61 (05-10), 545i E60/61 (03-06), 550i E60/61 (05-10).

BMW 6 SERIES: 645i E63/64 (03-06), 650i E63/64 (05-11).

BMW 7 SERIES: 735i E65/66 (02-05), 740i E65/66 (05-10), 745i E65/66 (02-05), 750i E65/66 (05-08), 760i E65/66 (02-08).

BMW X SERIES: X5 4.4 E53 (03-07), X5 4.8 E53/E70 (04-10).

FERRAMENTAS OEM

119463 (1), 119462 (2), 119340 (3), 119461 (4), 119190 (5)

CÓDIGOS DE MOTOR

3.6 V8: N62 B36A  
4.0 V8: N62 B40A  
4.4 V8: N62 B44A  
4.8 V8: N62 B48B  
6.0 V12: N73 B60A

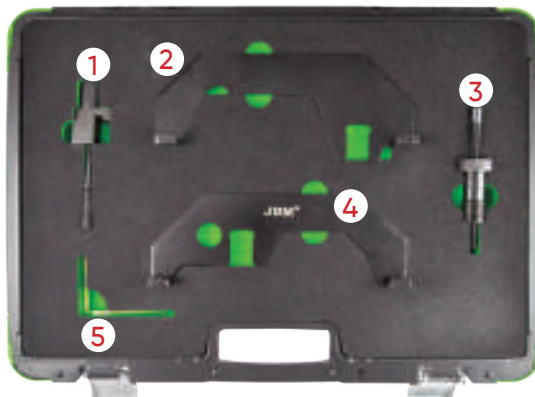

# KIT DE BLOQUEIO BMW

53266

224,00€

DIESEL/GASOIL

GASOLINA/PETROL



MARCAS

BMW

FERRAMENTAS OEM

113240 (1), 115490 (2), 113190 (3), 112300 (4) (5), 113292 (6), 113320 (7)

CÓDIGOS DE MOTOR

GASOLINA: M42, M43, M50, M52, M60.  
DIESEL: M51

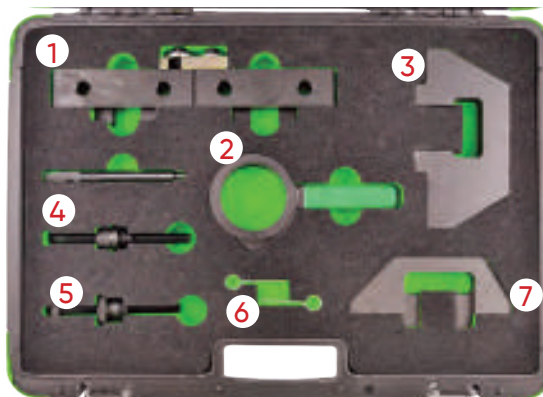

# KIT DE BLOQUEIO BMW

53269

50,00€

DIESEL/GASOIL

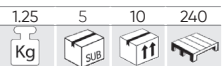

MARCAS

BMW

BMW 1 SERIES: 116d E81/82/87/88 (08-12), 118d E81/82/87/88 (07-14), 120d E81/82/87/88 (07-14), 123d E81/82/87/88 (07-14).

BMW 2 SERIES: 218d (11-14), 220d (11-14), 225d (11-14).

BMW 3 SERIES: 316d E90/91/92/93 (09-12), 318d E90/91/92/93 (07-12), 320d E90/91/92/93 (07-12), 325d E90/91/92/93 (10-14), 330d/xd E90/91/92/93 (08-14).

BMW 5 SERIES: 520d E60/61 (07-10), 525d F10/11 (10-12), 530d F10/11 (10-13), 530dGT F07 (09-12), 535d F10/11 (10-17), 535dGT F07 (10-12).

BMW 7 SERIES: 730d/Ld F01/02/04 (08-12), 740d F01/02/04 (09-12), 740d xDrive F01/02/04 (09-12), 750d xDrive F01/02/04 (12-15).

BMW X SERIES: X1 sDrive 18d E84 (09-15), X1 sDrive 20d E84 (09-12), X1 xDrive 18d E84 (09-15), X1 xDrive 20d E84 (09-15), X1 xDrive 23d E84 (09-12), X3 2.0d E83 (07-10), X3 xDrive 18d E83 (08-10), X3 xDrive 30d E83 (11-12), X3 xDrive35d F25 (11-17), X5 3.0d E70 (10-13), X5 xDrive 40d X5 F15 M50d (13-17), E70 (10-13), X6 xDrive 30d E71/72 (10-14), X6 xDrive 40d E71/72 (10-14), X6 F16 M50d (14-17).

BMW MINI: Paceman (13-17), Countryman (10-17), Mini (10-15), Roadster (12-14), Clubman (10-14), Clubvan (12-14).

FERRAMENTAS OEM

118760 (1), 118740 (2), 116480 (3), 115320 (4)

CÓDIGOS DE MOTOR

1.6 D: N47, C16K1, C16U1.  
2.0 D: N47, C20K1, C20U1N47, D20, D20A, D20B, D20D, D20K1, D20O0, D20O1, D20T1, D20U0, D20U1, N47S D20T0, N47T, D20, D20O1, D20U1.  
3.0 D: N57, B30B, B30B/T0, B30C, D30BTO, D30O0, D30O1, D30T0, D30T1, D30U0.

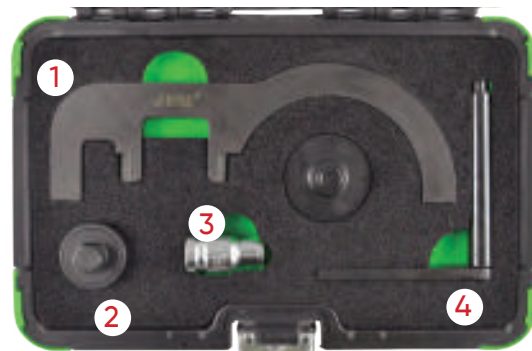



## KIT DE BLOQUEIO DE DISTRIBUIÇÃO PARA BMW & MINI 1.5/ 2.0L

**54206** 113,00€ **GASOIL/DIESEL**

1.75 - 5 135  
Kg SUB ff



<b>MARCAS</b>	<b>BMW</b> - 1 Series - 114d, 116d, 214d - (F20/ 21) - (2015- 2017) - 2 Series - 216d, 118d, 125d - (F22/ 23/ 45/ 46) - (2014-2017) - 3 Series - 218d, 220d, 225d - (F30/31/34) - (2015-2017) - 4 Series - 316d/320d/325d - (F32, 33, 36) - (2015-2017) - 5 Series - 420d, 425d, 418d - (F10, 11) - (2014-2017) - X1 Series - 518d - (F48) - (2015-2017) - X3 Series - (F25) - (2014-2017) - Efficient Dynamics - X4 Series - (F26) - (2014-2017) - xDrive - X5 Series - (F15) - (2015-2017) - sDrive <b>Mini</b> - Clubman - (F54) - (2015-2017) - One D Convertible - (F57) - (2016-2017) - Cooper D/ SD Mini Hatch (F55, 56) - (2014-2017)
<b>FERRAMENTAS OEM</b>	114120 (1), 2347904 (2), 2365488 (3), 2288380 (4), 118760 (5), 118740, 118030 (6)
<b>CÓDIGOS DE MOTOR</b>	1.5: B37 D15A, B37 C15A 2.0: B47 D20A, B47 D20B, B47 C20A, B47, B47 C20B

## KIT DE BLOQUEIO BMW MINI / PSA 1.4 / 1.6

**53268** 92,00€ **GASOLINA/PETROL**

2.60 - 5 120  
Kg SUB ff



<b>MARCAS</b>	<b>BMW MINI:</b> Mini Clubvan R55 (12-14), Mini Clubman R55 (08-14), Mini Countryman R55 (07-10), Mini Clubman R56/R57 (07-15), Mini R56/R57 (08-15), Mini Coupe R58 (11-15), Mini Roadster R59 (08-15), Mini Clubman R60 (10-14), Mini Clubvan R60 (12-14), Mini Roadster R61 (13-15), Mini Paceman R61 (14-15), Mini Countryman R60 (10-17). <b>CITROËN:</b> C4 (08-11), C4 Picasso (08-13) C4 Grand Picasso (13-15). <b>PEUGEOT:</b> 207 (06-14), 207CC (07-15), 308 (07-15), 3008 (09-15), 5008 (09-15).
<b>FERRAMENTAS OEM</b>	<b>BMW MINI:</b> 115590 (1), 119340 (2), 119551 (3) <b>CITROËN:</b> 0197-A1, 0197-A3, 0197-B. <b>PEUGEOT:</b> 0197-A1, 0197-A3, 0197-BZ.
<b>CÓDIGOS DE MOTOR</b>	1.4: N12B14, N14B14AB. 1.6: EP3(8FS), EP3C(8FR), EP6(5FW), EP6C(5FS), EP6CDT(5FV), EP6DT(5FT), EP6DT(5FX), EP6DTS(5FY), N14B16A, N14B16CD, N14B16TO, N14B16CD/TO, N16B16A, N16B16KO, N16B16A/MO, N16B16A/MO, N16B16MO, N16B16UO.

## KIT DE BLOQUEIO BMW MINI N13, N18

**54227** 122,00€ **GASOLINA/PETROL**

2.40 - 5 135  
Kg SUB ff



<b>MARCAS</b>	BMW : Serie 1 (2011 - 2015), Serie 3 (2012 - 2015). MINI: Clubman (2011 - 2014), Mini (2010 - 2015), Coupe (2011 - 2015), Roadster (2012 - 2015), Countryman (2010 - 2017) and Paceman (2013 - 2017).
<b>FERRAMENTAS OEM</b>	117440 (1), 119340 (2), 2299362 (3)
<b>CÓDIGOS DE MOTOR</b>	N12, N13, N14, N18, EP3, EP6

## KIT DE BLOQUEIO BMW/MINI/CITROËN/PEUGEOT

**54219** 60,00€ **GASOLINA/PETROL**

1.09 - 5 135  
Kg SUB ff



<b>MARCAS</b>	BMW, MINI, PSA
<b>FERRAMENTAS OEM</b>	115140(1), 119280(2), 119330(3), 113340 (4), 114360 (5)
<b>CÓDIGOS DE MOTOR</b>	<b>BMW</b> 1.6 (N40 / N45 / N45T, B16, B16A, B16AC) 1.8 / 2.0 (N42 / N46 / N46T) 2.0 / 3.0 (N51 / N52 / N52-Componente / N53 / N54) <b>PSA</b> 1.4 / 1.6 16V (EP3 / EP6 / EP6DT / EP6DTS) <b>MINI</b> 1.4 / 1.6 (N12 / N14)

# FERRAMENTA DE INSTALAÇÃO E REMOÇÃO DE INJETORES DE COMBUSTÍVEL **BMW MERCEDES BENZ**

**54220**

197,00€

GASOLINA/PETROL

4,40	-	2	240
Kg	Sub	ff	

**MARCAS**

**BMW:**  
135is (2008-),335 (2007-),335xi (2007-),535i (2008-),535xi (2008-),550i GT (2010-),750Li (2009-)  
750i (2009-), X3 3.0i (2007-),X5 (2011-),X5 3.0i (2008-),X6 (2008-)  
**MERCEDES-BENZ:**  
C-class (2007-),CLK / SLK (2007-),E-class (2007-),A / CLA / GLA 45 AMG (2013-),CL / CLS 63 AMG (2010-),E / G / GL 63 AMG (2011-),GLE 63 AMG (2015-S / SL 63 AMG (2010-),SLK 55 AMG (2012-)

**FERRAMENTAS OEM**

BMW : 130180(1), 130195(2), 130270(3), 130320(4), 2249115(5)  
Mercedes-Benz: 271589023300(6), 278589003300(7)

**CÓDIGOS DE MOTOR**

BMW : N14 / N18 / N20 / N47 / N54 / N57 / N55 / N63  
Mercedes-Benz : M133 / M152 / M157 / M270 / M271 / M274 / M276 / M278

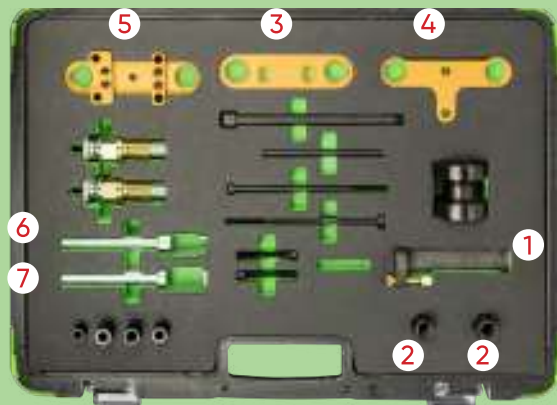

## KIT DE BLOQUEIO **MERCEDES BENZ M271**

**53271**

227,00€

GASOLINA/PETROL

GASOIL/DIESEL

4,55	-	2	40
Kg	Sub	ff	

**MARCAS**

MERCEDES

**FERRAMENTAS OEM**

271 589 003100 (1), 271589014000 (2), 271589001500 (3), 156589006100 (4)

**CÓDIGOS DE MOTOR**

M271, E18ML 2002, DE18ML 2003 - 2005, E16ML 2008, DE18LA 2009.

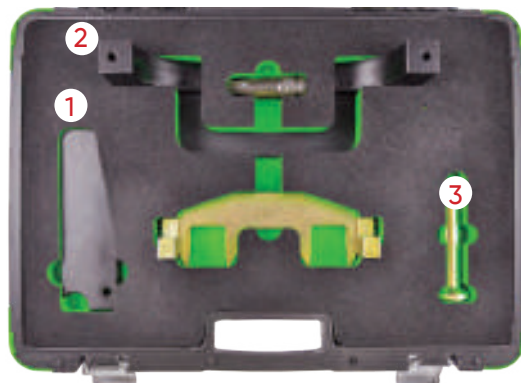

## KIT DE BLOQUEIO **MERCEDES AMG 156**

**53272**

195,00€

GASOLINA/PETROL

GASOIL/DIESEL

2,10	-	5	160
Kg	Sub	ff	

**MARCAS**

MERCEDES

**FERRAMENTAS OEM**

156589006100 (1), 156589003200 (2), 156589016300 (3), 156589006900 (4)

**CÓDIGOS DE MOTOR**

BENZ AMG 156,ML 63 AMG.S 63L AMG.S 63. AMG. R 63 AMG L 4MATIC. R63 AMG 4MATIC. E 63 AMG. CLS 63 AMG. CLK 63 AMG. CLK 63 AMG Black series. CLK 63 AMG Cabrio. CL 63 AMG.

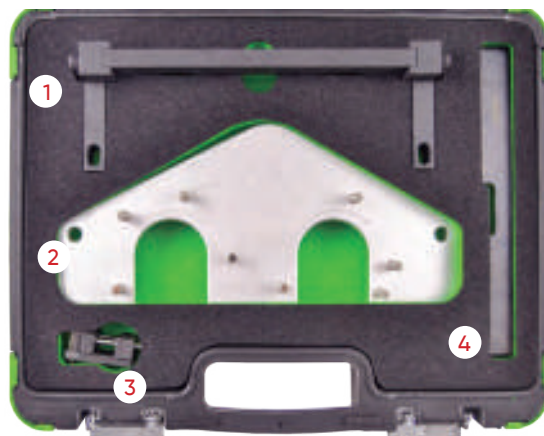

## KIT DE BLOQUEIO **MERCEDES / CHRYSLER / JEEP**

**53270**

70,00€

GASOLINA/PETROL

GASOIL/DIESEL

1,40	-	10	-
Kg	Sub	ff	

**MARCAS**

MERCEDES  
CHRYSLER  
JEEP

**FERRAMENTAS OEM**

112589034000 (1), 601589024000 (2), 111589031500 (3)

**CÓDIGOS DE MOTOR**

Herr.: 112 589 03 40 00: 112, 113, 137, 155, 156, 272/979, 273, 629, 642/992.  
Herr.: 601 589 02 40 00: 102, 103, 104, 111, 601, 602.91/93/94/96/983, 603.91/93/96/97, 604, 605, 606, 611, 612/965/966, 613.  
Herr.: 111 589 03 15 00: 111, 119, 604, 605, 606, 611/980, 612, 613, 628, 629, 640, 642/922, 612.965/966, 646, 647, 648.

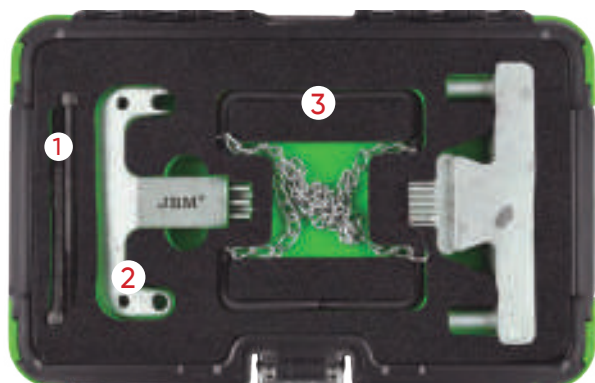



# KIT DE BLOQUEIO MERCEDES M276 / M157 / M278

53273 75,00€

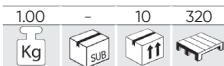

GASOLINA/PETROL

GASOIL/DIESEL



MARCAS	MERCEDES	
FERRAMENTAS OEM	27658901400	
CÓDIGOS DE MOTOR	CL 500 / 63 AMG (C 216) 2010-2013. S 500 / 63 AMG (C 217) 2014. CLS 300 (C 218) 2012. E 300 / 350 / 400 (C/A 207) 2011. CLS 350 / 400 / 500 / 63 AMG (C/X 218) 2011-2014. SLK 350 (R 172) 2011. SL 350 / 400 / 500 / 63 AMG (R 231) 2012. S 500 PLUG-IN HYBRID (V 222) 2014. ML 300 / 350 / 500 / 63 AMG (W 166) 2011.	C 400 (W 205) 2014. E 400 HYBRID (W 212) 2012. G 63 AMG (W 463) 2012. E 300 / 350 / 400 / 500 / 63 AMG (W/S 212) 2011. C 350 (W/S/C 204) 2011. S 350 / 500 / 63 AMG (W/V 221) 2010. S 400 / 63 AMG (W/V 222) 2013. R 350 BlueEFFICIENCY (W/V 251) 2012. GL 450 / 500 (X 166) 2012. GLK 350 (X 204) 2011.

# KIT DE BLOQUEIO DE DISTRIBUIÇÃO CHRYSLER 2.5 JEEP LDV CRD

54207 38,90€



GASOIL/DIESEL



MARCAS	Chrysler: Voyager (01-08), Grand Voyager (01-08) Jeep: Cherokee (01-08) LDV: Maxus (05-09)	
FERRAMENTAS OEM	VM 9660 (1), VM1052 (2), VM1053 (3), VM1068 / VM1089 (4), VM1080 (5), VM8873 (6)	
CÓDIGOS DE MOTOR	2.5D CRD: R2516C, R2516K, R2516LVM39/40B.	2.8D CRD: R2816C5.05A, R2816K4.

# KIT DE BLOQUEIO VAG 1.2 TFSI

54092 24,00€



GASOLINA/PETROL

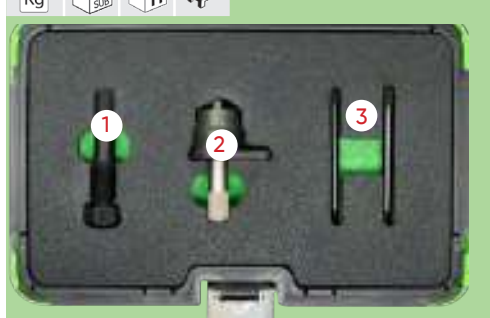

MARCAS	Audi: A1, A3, A3 Sportback, A3 Cabrio Seat: Altea, Altea XL, Ibiza, Leon, Toledo Skoda: Fabia II, Oktavia II, Praktik, Rapid, Rapid Spaceback, Rommster, Yeti VW: Beetle, Caddy, Caddy Maxi, Golf Plus, Golf VI, Golf VI Cabrio, Golf VI Estata, Jetta, Polo, Touran
FERRAMENTAS OEM	T10340(1), T10414(2), T10341(3)
CÓDIGOS DE MOTOR	CBZA, CBZB, CBZC

# KIT DE FERRAMENTAS PARA CORREIA DE DISTRIBUIÇÃO VW / AUDI

53277 45,00€



GASOLINA/PETROL

GASOIL/DIESEL



MARCAS	GASOLINA AUDI: 80, 100, A3, A4, A6 1.6, 1.8/Turbo, 2.0, 2.0 16v, A3, A4 1.6 (96-). SEAT: Ibiza/Cordoba, Toledo, Alhambra, Inca 1.6, 1.8, 1.8 16v, 2.0, 2.0 16v/Ibiza/ Cordoba, Leon, Toledo 1.6 (99-), Alhambra 2.0 (00-). VOLKSWAGEN: Polo Classic, Scirocco, Corrado, Golf, Jetta, Vento, Passat, Sharan, Transporter 1.6, 1.8/Turbo, 1.8 16v, 2.0, 2.0 16v, Polo Classic, Golf, Bora, Beetle 1.6 (97-), 2.0 (99-). SKODA: Octavia 1.6 (97-), 2.0 (99-). DIESEL AUDI: 80, 100, A3, A4, A6 1.9 Turbo D, 1.9TDi, 2.5TDi, A3, A4, A6 2.0TDi, A2, A3, A4, A6 1.2TDi, 1.4TDi, 1.9TDi (99-). SEAT: Ibiza/Cordoba, Leon, Toledo, Alhambra, Inca 1.7SDi, 1.9D/TD /Sdi/Tdi. FORD: Galaxy (02-06). SKODA: Felicia, Octavia 1.9D/Tdi. VW: Polo, Polo Classic, Golf, Jetta, Vento, Bora, Beetle, Passat, Sharan, Caddy, Transporter 1.5D, 1.6D/ Turbo, 1.7D/Sdi, 1.9Sdi/Tdi, Golf, Passat 2.0TDi.
FERRAMENTAS OEM	T10020 (1), 3387 (2), V159 (3), T10060/T100604 (4), T10115 (5), T40011 (6)
CÓDIGOS DE MOTOR	2.0, 2.8, 3.0

## KIT DE BLOQUEIO DE DISTRIBUIÇÃO PARA VAG 1.2/1.4 TSI

53648 107,00€

GASOLINA/PETROL

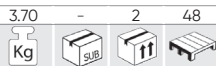

### MARCAS

AUDI: A1 (12-15), A1 Sportback (12-15), A3 (13-15), A3 Sportback (12-15).  
SEAT: Ibiza (12-15), Leon (12-15), Toledo (12-15).  
SKODA: Fabia (10-13), Octavia II (10-13), Octavia III (10-15).

### FERRAMENTAS OEM

T10060A (1), T10340 (2), T10476 (3), T10494 (4), T10499 (5),  
T10504/1 (6), T10504 (7), T10504/2 (8).

### CÓDIGOS DE MOTOR

1.2 TSi: CJZA, CJZB.  
1.4 TSi: CGGA, CHPA, CMBA, CPVA, CRJA, CXSA.  
1.4 TSi ACT: CPTA.

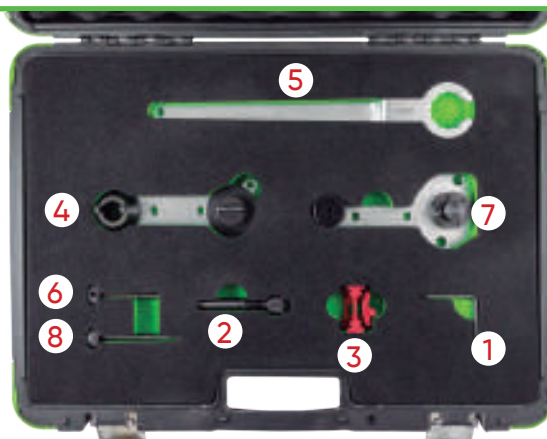

## KIT DE ALINHAMENTO DO EIXO DE COMANDO VAG 1.4/1.6/2.0 TDI COM O SISTEMA COMMON RAIL

53706 98,00€

GASOIL/DIESEL

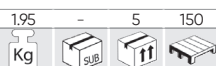

### MARCAS

VOLKSWAGEN: Golf Alltrack, Golf Sportsvan, Golf VII, Golf VII Kombi, Passat, Polo.  
AUDI: A1, A1 Sportback, A3, A3 Cabriolet, A3 Limousine, A3 Sportback, TT, TT Roadster.  
SEAT: Ibiza, Ibiza V Sportcoupe, Ibiza V ST, Leon, Leon SC, Leon ST, Toledo IV.  
SKODA: Fabia, Fabia Kombi, Octavia, Octavia Combi, Rapid, Rapid Spaceback.

### FERRAMENTAS OEM

OEM 3204 (1), OEM 3359 (2), OEM T10490 (3), OEM T10051 (4), OEM T10060A (5),  
OEM T10264 (6), OEM T10265 (7), OEM T10492 (8), OEM T40098 (9).

### CÓDIGOS DE MOTOR

1.4, 1.6, 2.0 TDI CR  
CXXB, DBKA, DCXA, CGLE, CKFB, CKFC, CLHA, CLHB, CNHA, CNHC, CRBD, CRFA, CRFC, CRKA, CRKB, CRLB, CRLC, CRMB, CRUA, CRVA, CRVC, CSUA, CSUB, CUNA, CUPA, CUSA, CUSB, CUTA, CUUD, CXEB, DBKA, DCXA, DCZA, DFSD.

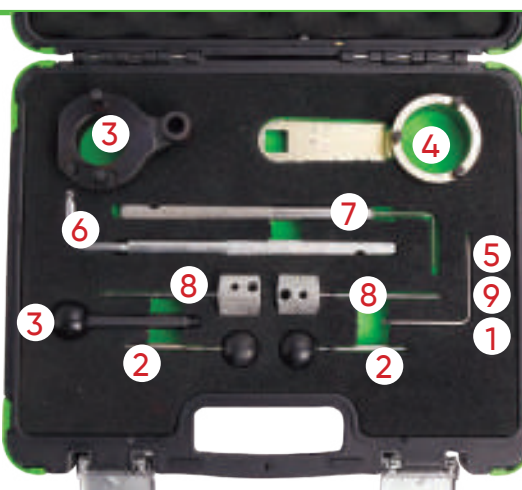

## KIT DE BLOQUEIO VAG 2.5 / 4.9D / TDI

53284 306,00€

GASOIL/DIESEL

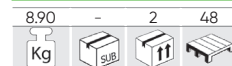

### MARCAS

VOLKSWAGEN: Touareg (03-10), Transporter (03-09).

### FERRAMENTAS OEM

T10225 (1), T10199 (2), T10234 (3), T10226 (4), T10193 (5),  
T10194 (6), T10199/01 (7), T10226 (8)

### CÓDIGOS DE MOTOR

2.5D TDi PD: AXD, AXE, BAC, BLJ, BLK, BNZ, BPC, BPD, BPE.

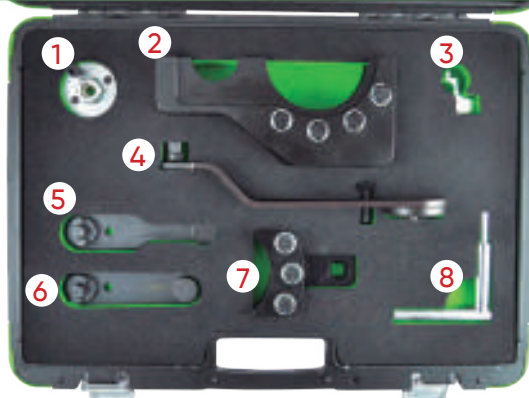

## KIT DE BLOQUEIO AUDI V6 2.0 / 2.8 / 3.0 TFSI

53278 143,00€

GASOLINA/PETROL

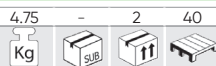

### MARCAS

A2, A4, A4 Quattro, A6 (2004-2007)  
A2, A3, A4, A3 FSI (2004-2007)  
A4, A6, A8 3.2 FSI  
A6 L Quattro 2.4  
A6 2.4, A6 2.4 Quattro (2004-2007)  
A4 3.2 FSI (2004-2007)  
A6 3.2 FSI (2004-2007)  
A8 3.2 FSI (2005-2007)

### FERRAMENTAS OEM

T10172 (1), 3212 (2), T40070 (3), T40069 (4), T40071 (5), T10172/2 (6)

### CÓDIGOS DE MOTOR

AUK / BDW / BDY / BKH / CAJA / CALA

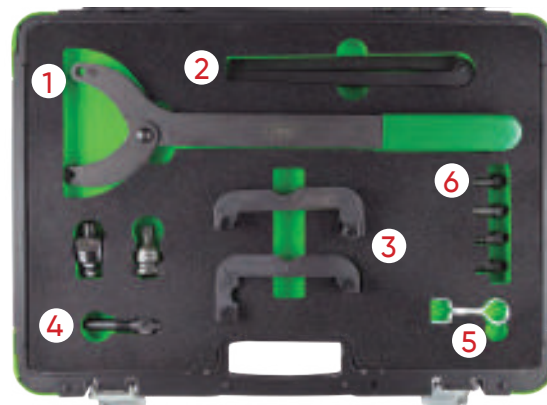



## KIT DE BLOQUEIO AUDI / SKODA

53276

160,00€



GASOLINA/PETROL

GASOIL/DIESEL

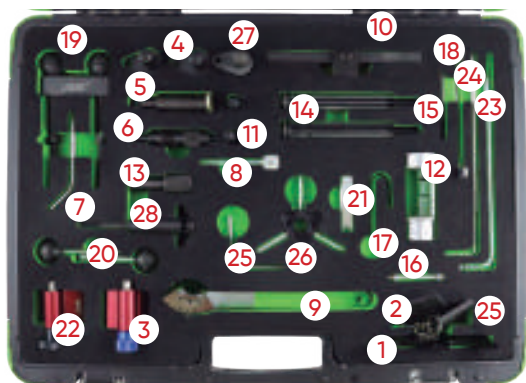

### MARCAS

MOTORES AUDI\_VW: V6 2.0, 2.8, 3.0T FSI.  
AUDI Q5: 2.0, A6L 2.8, 3.0T.

### FERRAMENTAS OEM

3418 (1), 3458 (2), T10100 (3), T10123 (4), T10121 (5), 3242 (6), 3551 (8), T10020 (9), T10098 (10), 3078 (12), 2064 (13), 3369 (14), T10092 (15), T40011 (17), 2065A (18), T10016 (19), 3359 (20), T10008(21), T10050 (22) T10265 (23), T10264 (24), T10060A (25), T10120 (27), 3366 (28)

### CÓDIGOS DE MOTOR

2.0, 2.8, 3.0

## KIT DE ALINHAMENTO EIXO DE COMANDO VW / AUDI

53281

55,00€



GASOIL/DIESEL



### MARCAS

VOLKSWAGEN: 2.5 TDI V6 DIESEL  
AUDI: A4, A6, A8

### FERRAMENTAS OEM

3369 (1), 3242 (2), 3458 (3)

### CÓDIGOS DE MOTOR

AFB/AKN

## KIT DE BLOQUEIO VW / AUDI

53282

48,00€



GASOLINA/PETROL



### MARCAS

SEAT: Alhambra (10-15), Altea/Altea XL (08-15), Ibiza/ Cordoba (08-12), Leon (07-13), Toledo (07-15).  
VOLKSWAGEN: Beetle (11-15), Caddy/Caddy Maxi (10-15), EOS (06-12), Golf (03-12), Golf Plus (03-14), Golf V Estate (07-13), Golf VI Cabriolet (10-15), Jetta (06-14), Passat (05-11), Polo (02-14), Scirocco (08-12), Tiguan (07-12), Touran (03-15).  
SKODA: Fabia II (07-15), Octavia II (04-15), Praktik (10-15), Rapid (12-15), Roomster (06-15), Superb II (09-14), Yeti (09-14).  
AUDI: A1 (10-15), A3 (03-13).

### FERRAMENTAS OEM

T10171 (1), T10170 (2), T40011 (3)

### CÓDIGOS DE MOTOR

1.2 TFSI: CBZA, CBZB, CBZC.  
1.4 FSI: AXU, BKG, BLN.  
1.4 TFSI: BLG, BMY, BWK, CAVA, CAVB, CAVC, CAVD, CAVE, CAVF, CAXA, CAXC, CDGA, CSMA.  
1.6 FSI: BAG, BLF, BLP, BTS.

## KIT DE BLOQUEIO VOLKSWAGEN / SEAT / SKODA 1.2L

53274

30,50€



GASOLINA/PETROL

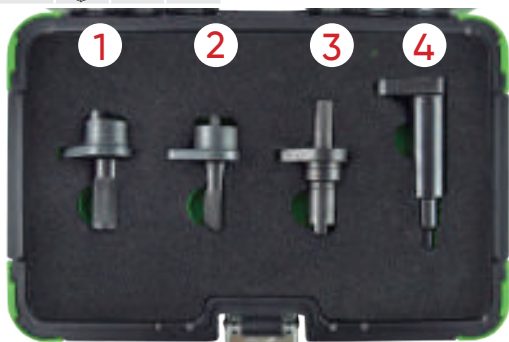

### MARCAS

VOLKSWAGEN  
1.2: Lupo / Polo / Eos / Fox.  
SEAT  
1.2: Ibiza / Cordoba  
SKODA  
1.2: Fabia

### FERRAMENTAS OEM

T10123 (1) (2), T10120 (3), T10121 (4)

### CÓDIGOS DE MOTOR

AWY / BMD / AZQ / BME.

## KIT DE BLOQUEIO VW / AUDI 2.0TFSI

53279 97,00€



GASOLINA/PETROL

### MARCAS

**AUDI:** A3 (96-09), A4 (94-09), A6 (95-11), S3 (99-13), TT (98-14).  
**SEAT:** Alhambra (97-10), Altea/Altea XL (06-09), Cordoba (99-02), Exeo (09-10), Ibiza (99-02), Leon (99-13), Toledo (99-09).  
**SKODA:** Octavia/Octavia Tour (98-10), Octavia II (04-09).  
**VOLKSWAGEN:** Beetle (99-11), Bora (97-04), Eos (06-10), Golf (97-12), Golf Plus (05-09), Jetta (05-09), Passat (96-10), Scirocco (09-14), Sharan (97-10), Touran (03-09).

### FERRAMENTAS OEM

T10020 (1), T10252 (2), T10092 (3), T10115 (4), T40011 (4), 3366 (5), T10060 (6)

### CÓDIGOS DE MOTOR

1.8: ADR, AFY, AGN, AJP, APG, APT, AQE, ARG, ARH, AVV.  
 1.8T: AEB, AGU, AJH, AJL, AJQ, AMK, AMU, ANB, APP, APU, APX, APY, AQA, AQX, ARX, ARY, ARZ, AUM, AUG, AVB, AWC, AWT, AWU, AYP, BAM, BFV, BVP, BVR.  
 2.0 FSI: AXW, BHD, BLR, BLX, BLY, BMB, BVX, BVY, BVZ.  
 2.0 TFSI/S/R/Tsi: AXX, BPY, BWA, BGB, BPG, BPJ, BUL, BWE, BWT, BYK, BHZ, BZC, BWJ, BYD, CDLA, CDLB, CDLC, CDLD, CDLF, CDMA.



## KIT DE BLOQUEIO DE DISTRIBUIÇÃO PARA VAG TFSI, FSI

54199 94,00€



GASOLINA/PETROL

### MARCAS

**Audi:** A1 (10-15), A1 Sportback (10-15), A3 Cabriolet (10-13), A3 (10-15), A3 Sportback (03-13).  
**Seat:** Altea/Altea XL (10-15), Ibiza (10-15), Leon (10-13), Toledo (12-15).  
**Skoda:** Fabia II (10-15), Praktik (10-15), Rapid (12-15), Rapid Sportback (12-15), Octavia II (04-13), Yeti (09-15), Yeti Outdoor (13-15).  
**VW:** Beetle (11-15), Caddy/Caddy Maxi (10-15), EOS (07-15), Golf V (03-13), Golf V Estate (07-09), Golf VI (10-13), Golf VI Estate (10-13), Golf VI Cabriolet (11-15), Golf Plus (05-14), Jetta (05-14), Passat (05-15), Polo (09-14), Scirocco (08-14), Tiguan (07-15), Touran (03-15).

### FERRAMENTAS OEM

T10414(1), VAS 6079(2), T10170(3), T10171/ T10171A(4), T40011(5), T10340(6), T10341 (7)

### CÓDIGOS DE MOTOR

1.2 TFSI: CBZA, CBZB, CBZC  
 1.4 FSI/TFSI: BLG, BMY, BWK, CAVA, CAVB, CAVC, CAVD, CAVE, CAVF, CAXA, CAXC, CDGA, CSMA  
 1.6 FSI: BAG, BLF, BLP

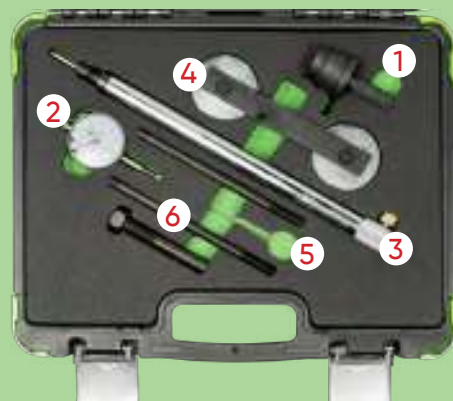

## KIT DE ALINHAMENTO EIXO DE COMANDO VW / AUDI

53280 112,00€

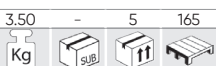

GASOLINA/PETROL

### MARCAS

**AUDI:** A4 (01-08), A6 (01-08), A8 (03-10).

### FERRAMENTAS OEM

3387 (1), T40030 (2) (4), T40026 (3), T40028 (5)

### CÓDIGOS DE MOTOR

3.0 V6 30v: ASN, AVK, BBJ, BGN.

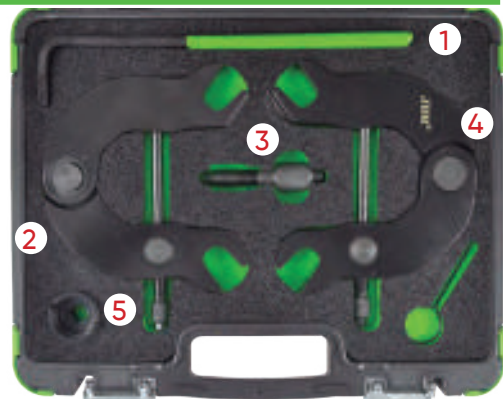

## KIT DE BLOQUEIO VW / AUDI

53326 16,00€

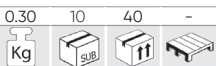

GASOIL/DIESEL



### MARCAS

**VW:** V6 2.5TDi.  
**AUDI:** V6 2.5TDi, V8 3.3TDi.

### FERRAMENTAS OEM

3458 (1), 3242 (2)

## KIT DE BLOQUEIO VW 1.2L

53327 11,00€

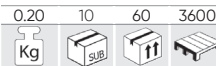

GASOLINA/PETROL



### MARCAS

**SEAT:** Ibiza 1.2 6v/3cyl (2002-09), Cordoba 1.2 12v/3cyl (2002-13).  
**VW:** Polo 1.2 6v-12v/3cyl (2002-14).  
**SKODA:** Fabia 1.2 6v-12v/3cyl (2002, 2003-), Fabia II 1.2 6v/3cyl (2007-13), Roomster 1.2 12v/3cyl (2006-13), Praktik 1.2 6v/3cyl (2007-13).

### FERRAMENTAS OEM

T10123.

### CÓDIGOS DE MOTOR

1.2 6v: AWY, BMD, BBM, CHFA, CHFB  
 1.2 12v: AZQ, BME, BVX, BZG, CEVA, CGPA, CGPB, CGPC.



## KIT DE BLOQUEIO VAG 2.7 / 3.0 TDI

53283 92,00€

GASOIL/DIESEL

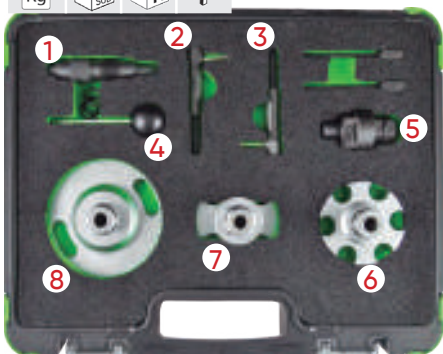

<b>MARCAS</b>	VOLKSWAGEN: Touareg, Phateon VAG: Diesel 2.7 / 3.0 V6 AUDI: A4, A5, A6
<b>FERRAMENTAS OEM</b>	3242 (1), T40060 (2) (3), 3359 (4), T40058 (5), T40061 (6), T40062 (7), T40049 (8)
<b>CÓDIGOS DE MOTOR</b>	ASB, BKN, BKS, BWZ, BNG, BPP, BSG, BUG, BUN, CAWA, CAMB, CANA, CANB, CANC, CAND, CAPA, CARA, CAR5, CASA, CASE, CASC, CAM, CC/HA, CCWA, CCWB, CDYA, CDVB, CDVC, CEXA, CGKA, CGKB.

## KIT DE BLOQUEIO VAG 2.4 / 2.5D SDI

53285 56,00€

GASOLINA/PETROL



<b>MARCAS</b>	VOLKSWAGEN: Crafter (06-13), LT (96-06), Transporter (90-03).
<b>FERRAMENTAS OEM</b>	2065A (1), T50009 (2), T10025 (3), 3248/3419 (4), 2064 (5), 3355 (6)
<b>CÓDIGOS DE MOTOR</b>	2.4D: AAB, AJA. 2.5D SDI: AGX. 2.5D Tdi: ACV, AHD, AHY, AJT, ANJ, APA, AUF, AVR, AXG, AXL, AYC, AYY, BBE, BBF. 2.5D TDiCR: BJJ, BJK, B JL, BJM.

## KIT DE BLOQUEIO VAG 1.8 / 2.0TSI

53286 87,00€

GASOLINA/PETROL

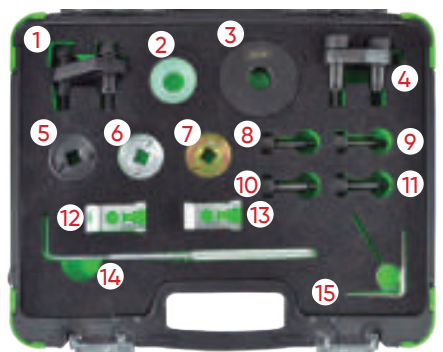
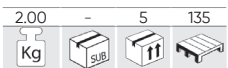

<b>MARCAS</b>	VOLKSWAGEN: 1.8 / 2.0 TSI / TFSI.
<b>FERRAMENTAS OEM</b>	T10368 (2), T10354 (3), T40271 (1)(4), T10352/2 (5), T10352/1 (6), T10352 (7), T40196 (8) (9) (10) (11), T40267(12) (13), T40098 (14), T10060A (15), T40011 (15)
<b>CÓDIGOS DE MOTOR</b>	BYT, BZB, CABA, CABB, CABD, CADA, CAEA, CAEB, CAWA, CAWB, CBFA, CCTA, CCZA, CCZB, CCZC, CDA, CDAB, CDHA, CDHB, CDNB, CDNC, CDND, CESA, CETA, CFKA, CGYA, CJEB, CJBA, CJSB.

## KIT DE BLOQUEIO VW / AUDI 1.8 / 2.0L TURBO

53287 245,00€

GASOLINA/PETROL

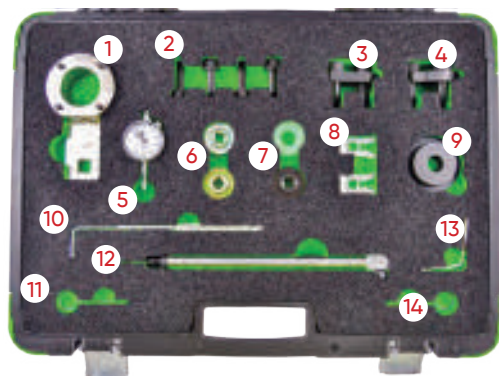

<b>MARCAS</b>	VOLKSWAGEN AUDI	1.8 / 2.0 TURBO
<b>FERRAMENTAS OEM</b>	T10355 (1), T40196 (2), T40271 (3) (4), T10352 (5), T10352/1 (6), T10352/2 (7), T10368 (7), T40267 (8), T10354 (9), T40265 (10), T40011 (11) (14), T40098 (12), T10060A (13)	
<b>CÓDIGOS DE MOTOR</b>	BYT, BZB, CABB, CABD, CADA, CAEA, CAEB, CAWA, CAWB, CBFA, CCTA, CCZA, CCZB, CCZC, CDA, CDAB, CDHB, CDNB, CDNC, CDND, CESA, CETA, CFKA, CGYA, CJEB, CJSB, CJSB.	

## KIT DE BLOQUEIO VW / AUDI

53275

35,50€

GASOIL/DIESEL

0,70	5	10	330
Kg	Sub	Box	Tray

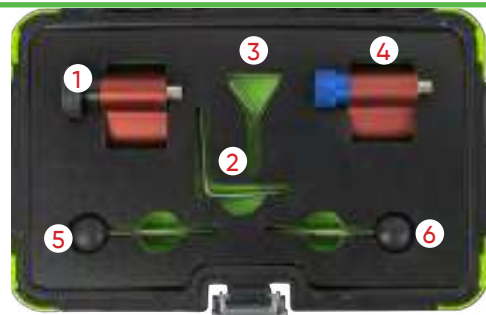

### MARCAS

DODGE: Caliber (06-11)  
 FORD: Galaxy (02-06)  
 MITSUBISHI: Grandis (05-10), Lancer (05-10), Outlander (07-10).  
 SEAT: Alhambra (00-15), Altea/Altea XL (04-15), Cordoba (02-09), Ibiza (02-15), Leon (00-13), Toledo (04-11).  
 SKODA: Fabia (00-14), Fabia II (07-15), Octavia (00-10), Octavia II (04-15), Praktik (10-15), Rapid (11-15), Roomster (07-15), Superb (02-08), Superb II (08-15), Yeti (09-14).  
 AUDI: A1 (10-15), A2 (00-06), A3 (01-13), A4/Allroad (01-16), A5 (08-15), A6 (11-14), TT (08-14), Q3 (11-15), Q5 (08-15), A6 (10-14).  
 VOLKSWAGEN: Amarok (10-16), Beetle (02-15), Bora (02-08), Caddy/Maxi (03-15), EOS (06-15), Fox (05-11), Golf (02-15), Golf Plus (05-14), Jetta (05-15), Lupo (02-05), Passat/CC (02-15), Polo (99-14), Scirocco (08-14), Sharan (02-15), Tiguan (07-15), Touran (03-15), Transporter (03-17).

### FERRAMENTAS OEM

DODGE: 9882, 9883.  
 FORD: 310-085/23-059, 303-1054.  
 MITSUBISHI: MB995206, MB995208, MB995209.  
 VAG: T10100 (4), T10050 (1), 3359 (3/6)/T20102, T10115 (3), T10060A (2)/T40098, T20167.

### CÓDIGOS DE MOTOR

1.2D TDi CR: CFWA.  
 1.4D TDi PD: AMF, BAY, BMS, BNM, BNV, BWB.  
 1.6D TDi CR: CAYA, CAYB, CAYC, CAYD, CAYE, CLNA.  
 1.9D TDi PD: AJM, ANU, ARL, ASZ, ATD, AUY, AVB, AVF, AVQ, AWX, AXB, AXC, AXR, BJB, BKC, BLS, BLT, BMT, BPZ, BRM, BRR, BRS, BRU, BSU, BSV, BSW, BTB, BVK, BXE, BXF, BXJ.  
 2.0D TDi CR/TDi PD: AZV, BDJ, BDK, BEW, BGW, BHW, BKD, BKP, BKQ, BLB, BMA, BMM, BMN, BMP, BMR, BNA, BPW, BRA, BRC, BRD, BRE, BRF, BRT, BSS, BST, BSY, BUY, BUZ, BVA, BVE, BVF, BVG, BVH, BWC, BWV, CAAA, CAAB, CAAC, CAAD, CAEE, CAGA, CAGB, CAGC, CAHA, CAHB, CBAA, CBAB, CBAC, CBBA, CBBB, CBDA, CBDB, CBDC, CBEA, CCHA, CCHB, CDBA, CDCA, CEGA, CFCA, CFFA, CFFB, CFFD, CFFE, CFGB, CFGC, CFHA, CFHB, CFHC, CFHD, CFHE, CFHF, CFJA, CGLA, CGLB, CGLC, CGLD, CJAA, CJCA, CJC, CJC, CJC, CLCA, CLCB, CLJA, CLLA, CNEA, ECD, ECD/BSY, ECD/BYL, ECE/BWD.

## KIT BLOQUEIO DE DISTRIBUIÇÃO PARA AUDI / VW / SEAT / SKODA

53649

89,00€

GASOLINA/PETROL

3,48	-	2	48
Kg	Sub	Box	Tray

### MARCAS

AUDI  
 SEAT  
 SKODA  
 VW

### FERRAMENTAS OEM

T10340 (1), T10476 (2), T10477 (3), T10487 (4), T10494 (5), T10499 (6)

### CÓDIGOS DE MOTOR

1.0 MPI: CHYA.  
 1.0 TSI: CHZE, CHZC, CHZA, CHZB, CHZC, CHZD, CHZJ.  
 1.2 TSI: CJZB, CJZC, CYVA, CJZA, CJZD, CYVB.  
 1.4 TSI: CZCC, CMBA, CZCA, CHPA, CPTA (ACT), CZDA, CVNA, CZEA (ACT).

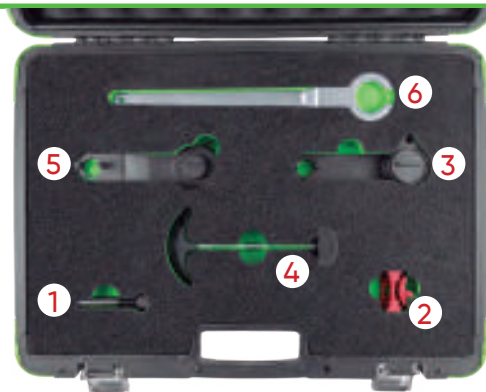

## KIT DE BLOQUEIO VAG 1.6 / 2.0L TDi PD COMMON RAIL

53288

72,00€

GASOIL/DIESEL

2,05	-	5	135
Kg	Sub	Box	Tray

### MARCAS

SEAT: Exeo, Leon, Altea, Toledo, Ibiza.  
 VOLKSWAGEN: Jetta, Touran, Golf, Golf Plus, Polo, Passat, Tiguan, Scirocco.  
 SKODA: Roomster, Fabia, Praktik, Octavia, Yeti, Superb.  
 AUDI: A1, A3, A4, A5, Q5, A6, TT.

### FERRAMENTAS OEM

T10264 (1), T10265 (2), T20102 (3), T10052 (4), T10051 (5), T10255 (6), T10050 (7), T10100 (8), T40098 (9)

### CÓDIGOS DE MOTOR

1.2 TDI CR, 1.6 D TDI CR, 2.0 D TDI CR

CAGA, CAGB, CAGC, CAHA, CAHB, CFHC, CBAA, CBAB, CFFB, CGLA, CGLB, CJCA, CJC, CJC, CAAA, CBAA, CBAB, CBAC, CBBA, CBBB, CBDA, CBDB, CBDC, CCHA, CEGA, CJAA, CAAB, CAAC, CFJA, CFWA, CAYB, CAYC, CAYA.



## FERRAMENTA DE MONTAGEM DE AMORTECEDOR DE VIBRAÇÃO VAG

54218

142,00€

GASOLINA/PETROL

1,95	-	5	135
Kg	Sub	Box	Tray

### MARCAS

AUDI, SEAT, SKODA, VOLKSWAGEN

### FERRAMENTAS OEM

T10531/1 (1), T10531/2 (2), T10531/3 (3), T10531/4 (4)

### CÓDIGOS DE MOTOR

1.8L TFSI:  
 BZB, CDAA, BPU, BYT, CABA, CABB, CDHA, CDHB, CABD, DAJB, CJSA, CJSB, CJEB, CJEE, CJED, CYGA, CDAC, CJSC, CGYA, DAJA  
 2.0L TFSI:  
 CAWB, CCZA, CBFA, CCTA, CDNB, CDNC, CDND, CJXA, CJXE, CJXH, CHHB, CHHA, CULA, CFKA, DEDA, CHJA, CAWA, CCZC, CCZD, CPSA, CJKA, CJKB, CESA, CETA, CFPA, CNCD, CPLA, CYRB, CYRC, CNCE, CYNB, CYP, CULB, CULC, CNCB, CWZA, CJXF, CJXC, CJXB, CJXG, CHHC, CCZB

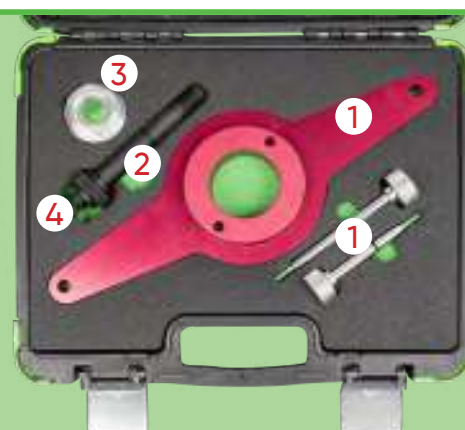



## KIT DE BLOQUEIO RENAULT 1.4 / 1.6 / 1.8 / 2.0 16V

53289

45,00€

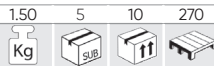

GASOLINA/PETROL

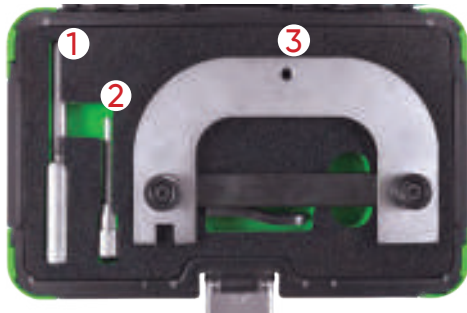

### MARCAS

**RENAULT:** Espace/Grand Espace (98-02), Espace/Grand Espace IV (02-10), Kangoo/Trekka (01-09), Laguna (98-01), Laguna II (01-07), Laguna III (07-13), Megane (99-03), Megane II (02-10), Megane III/Sport (08-13), Megane/Scenic (99-00), Scenic/RX4 (99-03), Scenic/Grand Scenic II (03-09), Trafic II (01-11), Twingo II (08-14), Vel Satis (00-10), Wind (10-14)  
**DACIA:** Logan/MCV (05-11).  
**NISSAN:** Kubistar X76 (03-09), Primastar (02-11).  
**VAUXHALL/OPEL:** Jetta, Touran, Golf, Golf Plus, Polo, Passat, Tiguan, Scirocco.

### FERRAMENTAS OEM

Mot1489 (1), Mot1054 (2), Mot1496 (3)

### CÓDIGOS DE MOTOR

1.4 16v K4J: 730, 732, 740.  
 1.6 16v K4M: 752, 753, 760, 761, 764, 788, 812, 813, 854, 856.  
 1.8 16v F4P: 720, 722, 760, 770, 771, 772, 773, 774, 775.  
 2.0 16v F4R: 700, 701, 712, 713, 714, 715, 720, 722, 730, 732, 736, 738, 740, 741, 744, 746, 747, 762, 763, 764, 765, 766, 767, 770, 771, 780, 790, 791, 792, 820, 830, 832, 867.  
 2.0 16v F4R(i): 720, 722, 764, 765, 774, 776, 784, 786, 787, 794, 795, 796, 797, 800, 802, 810, 811, 870, 872, 874, 886, 887, 896, 897.

## KIT DE BLOQUEIO RENAULT

53291

68,00€



GASOLINA/PETROL

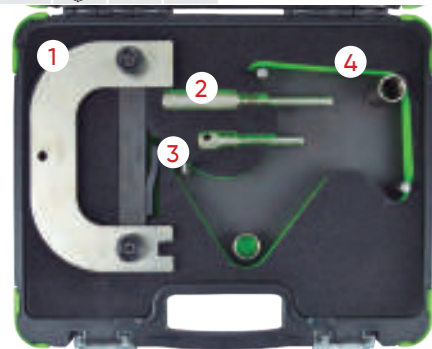

### MARCAS

**RENAULT:** Clio, Laguna, Megane

### FERRAMENTAS OEM

MOT1496 (1), MOT1489 (2), MOT861/1863 (3), MOT1490(4)

### CÓDIGOS DE MOTOR

K4J, K4M, F4P, F4R.

## KIT DE BLOQUEIO RENAULT / VOLVO 16V / 20V

53290

51,00€



GASOLINA/PETROL

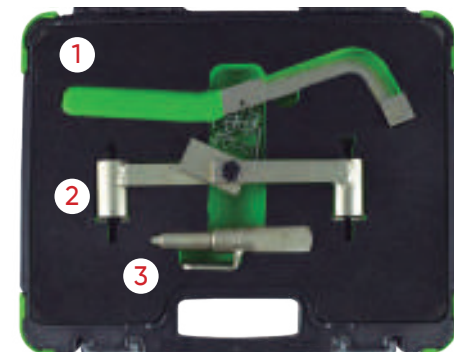

### MARCAS

**RENAULT:** Laguna 2.0 16V / 2.5 20V (1996-1999), Safrane 2.0 16V / 2.5 20V (1996-2001)  
**VOLVO:** 850 (1992-1997), C70 (1998-2002), S40 (1996-2004), V40 (1996-2004), S60 (2001-2005), S70 (1997-2000), S80 (1999-2005).

### FERRAMENTAS OEM

MOT1348 (1), MOT1337 (2), MOT1340 (3)

### CÓDIGOS DE MOTOR

**RENAULT:** N7Q 704/710/711(2.0 16V),N7U 700/701(2.5 20V).  
**VOLVO:** B4164S, B4164S2, B4184S, B4184S2, B4184S3, B4184S9, B4184S10, B4194T, BS194T2, B420S4, B4204S2, B4204T, B4204T2, B4204T3, B4204T5, B5202Fs, B5204FT, B5204T2, B5204T3, B5204T4, B5204T5, B5234FS, B5204FT, B5234T3, B5234T4, B5234T5, B5234T6, B5234T7, B5234T8, B5234T9, B5244S, B5244S2, B5244SG, B5244SG2, B5244T, B5244T3, B5244T4, B5244T5, B5244T7.

## CONJUNTO DE BLOQUEIO DE MOTORES A DIESEL RENAULT / NISSAN 1.6 DCI

53523

91,00€



GASOIL/DIESEL



### MARCAS

**RENAULT:** Espace/Grand Espace IV (06-10), Kaleos (08-11), Laguna II (05-07), Laguna III (07-12), Master III (10-12), Magane II (06-10), Scenic/Grand Scenic II (06-09), Scenic/Grand Scenic III (09-12), Trafic II (06-12), Vel Satis (05-10)  
**NISSAN:** Primastar X83 (06-10), Qashqai/Qashqai+2 J10 (07-10), X-Trail T31 (07-12).  
**VAUXHALL / OPEL:** Movano-B (10-12), Vivaro (06-12).

### FERRAMENTAS OEM

MOT1969 (1), MOT1970 (2), MOT1770, MOT1773, EN-48330, EN-48332, EN-48334, EN-48831, KM-6130

### CÓDIGOS DE MOTOR

M9R 2.0dCi: 610, 615, 630, 700, 721, 740, 742, 760, 761, 762, 763, 780, 782, 784, 786, 788, 800, 802, 803, 805, 808, 816, 830, 832, 833.  
 M9T 2.3dCi: 670, 672, 676, 678, 680, 686, 690, 692, 694, 698.





# KIT DE BLOQUEIO FORD

53293 134,00€

GASOLINA/PETROL

GASOIL/DIESEL

4,15 - 2 42  
Kg SUB

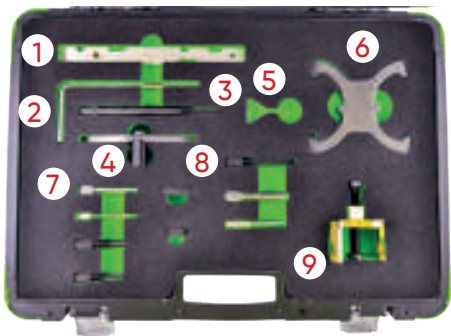

<b>MARCAS</b>	FORD	B-Max (12-17), C-Max (07-17), Cougar (98-01), Courier (00-02), Escort (94-98), Fiesta (95-17), Focus (98-17), Focus C-Max (03-07), Fusion (02-12), Galaxy (06-15), Grand C-Max (10-17), Kuga (08-15), Maverick (01-07), Mondeo (93-15), Orion (94-94), Puma (97-02), S-Max (06-15), Tourneo Connect (02-15), Transit (06-11), Transit Connect (02-16), EcoSport (13-15), Tourneo Courier (14-15), Grand Tourneo Courier (13-15).
<b>FERRAMENTAS OEM</b>	303-376 (21-162B) (1), 303-1059 (2), 303-193 (21-104) (3), 303-393-01 (4), 303-1054 (5), 303-1097 (6), 303-748 (7), 303-734 (21-262) (8), 303-651 (21-229) (9), 303-393A (21-168) / 303-393-02 / 303-507 (21-210) / 303-620 (21-163) / 303-732 (21-260) / 303-735 (21-263).	
<b>CÓDIGOS DE MOTOR</b>	<p>GASOLINA: AODA/B, ASDA, ASDB, CFBA, CGBA/B, CHBA/B, CJBA/B, CSDA/B, DHA, DHB, DHC, DHG, DHE, DHF, DHG, EDBB, EDBD, EDDB, EDDC, EDDD, EDDF, EYDB, EYDC, EYDD, EYDE, EYDF, EYDG, EYDI, EYDJ, EYPA, EYPC, F8JA, F8JB, FHA, FHD, FHE, FHF, FUJA, FUJB, FXDA/C, FXDB/D, FXJA, FXJB, FYDA/C, FYDB/D, FYJA, FYJB, HWDA, HWDB, LIF, LIJ, LIL, LIN, LIQ, LIT, LIV, LIW, M7JA, M7JB, MHA, MHB, NGA, NGB, NGC, NGD, QQDA/B/C, QQDB, RKA, RKB, RKF, RKH, RKJ, RKK, HXDA.</p> <p>DIESEL: F6JA, F6JB, F6JC, HHJA, HHJB, G8DA, HHDA, HHDB, RTN, RTQ, RTP, C9DC, BHDA/B, BHPA, C9DA/B, F9DA/B, FFBA, FFDA, HCPA, HCPB, KKDA, P7PA, P9PA, QYWA, R2PA, R3PA, RWPA, G6DA, G6DB, G6DC, AZWA, QXWA.</p>	

# FERRAMENTA DE BLOQUEIO DE ÁRVORE DE CAMAS PARA FORD 1.5T

54223 149,00€

GASOIL/DIESEL

2,40 - 5 135  
Kg SUB

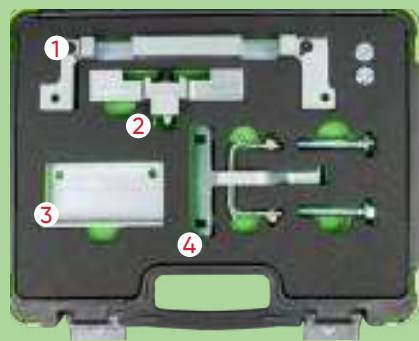

<b>MARCAS</b>	FORD, 1.5L Duratec, EcoSport, Fiesta, Focus
<b>FERRAMENTAS OEM</b>	303-1639(1), 303-1643(2), 303-1647(3), 303-1648(4)
<b>CÓDIGOS DE MOTOR</b>	2.2 / 2.5

# MULTIPLICADOR DE BINÁRIO 5:1 PARA MOTORES FORD ECOBOOST

54260 277,00€

7,50 - 1 240  
Kg SUB



1.0 EcoBoost 2.0 Durator-TDCi  
1.0 Duratec 2.0 EcoBlue Diesel  
2.0 Duratec

# KIT DE BLOQUEIO FORD

53653 207,00€

GASOLINA/PETROL

5,50 - 2 48  
Kg SUB

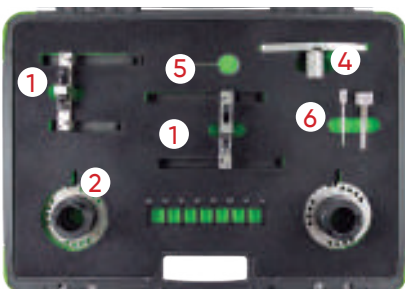

<b>MARCAS</b>	FORD: Fiesta, Focus, B-MAX, EcoSport.
<b>FERRAMENTAS OEM</b>	303-1605 (1), 303-1606 (2), 303-1604 (3), 303-1602 / 503-393A / (21-168) (4), 303-1054 (5), 303-732 (6)
<b>CÓDIGOS DE MOTOR</b>	M1DD, M1JA, M1JC, M1JE, M1JHM1JJ, M1DA, M2DA, M2DB, M2DC, SFDBSFJA, SFJB, SFJC, SFJD

# KIT DE BLOQUEIO DE DISTRIBUIÇÃO FIAT, FORD, OPEL, SUZUKI 1.3L

54211 74,00€

GASOIL/DIESEL

1,95 - 5 135  
Kg SUB

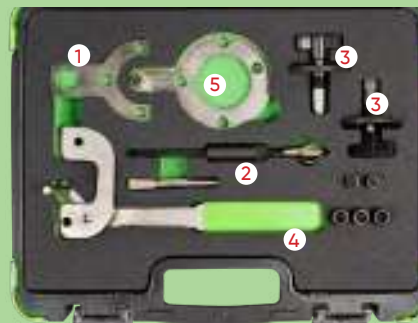

<b>MARCAS</b>	Fiat: Punto (2003-2007) / Panda (2003-2009) / Idea (2004-2006) / Doblo (2004-2006). Ford: KA. Vauxhall / Opel: Agila (2003-2008) / Corsa C (2003-2007) / Corsa D (2006-2009) / Combo C (2003-2009) / Astra H (2004-2009) Tigra B (2004-2009) / Meriva (2004-2009). Suzuki: Ignis (2003-2009) / Wagon R (2003-2009) / Swift (2003-2010).
<b>FERRAMENTAS OEM</b>	1871000200/303-1469/KM-662-C (1), EN 46785/KM 955/09912-38300 (2), 1871000900/1860985000/303-1472/EN 46781/09917-68610(3), 1870900400 (4), 1870900300 / 303-1468 (5)
<b>CÓDIGOS DE MOTOR</b>	Fiat: 1.3 JTD 188A9.000 / 169A.000 / 188A8.000 / 199A3.000. Ford: 1.3 TDCi. Vauxhall / Opel: 1.3 CDTi Z13DT / Z13DTH / Z13DTJ. Suzuki: 1.3 CDTi Z13DT.

# JOGO DE INSTALAÇÃO/REMOÇÃO DE BOMBA DE INJEÇÃO PARA FORD 2.0

54224 64,50€

GASOIL/DIESEL

1,75 - 5 135  
Kg SUB

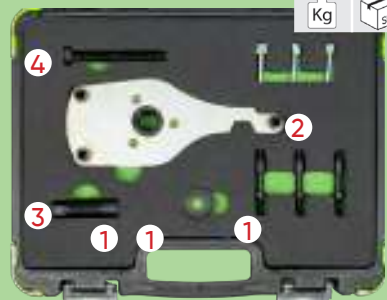

<b>MARCAS</b>	FORD: Transit (17-18), Tourneo Custom (16-18), Transit Custom (16-18)
<b>FERRAMENTAS OEM</b>	303-1635(1)/3, 3.3--1635(2)/1, 303-1635(3)/2, 303-1635(6)/4
<b>CÓDIGOS DE MOTOR</b>	YLFS, YMFS, YNFS, YLF6, YMF6, YNF6, YLR6, YMR6 and YNRS.

## KIT DE BLOQUEIO DE DISTRIBUIÇÃO PARA FORD 2.0 ECOBLUE

54204 124,00€

2,55 - 5 135  
Kg SUB

GASOIL/DIESEL

**MARCAS**  
Ford Edge, Focus, Galaxy, S-MAX (from 2018); Kuga, Mondeo, Ranger (desde 2019); Transit, Transit Custom and Tourneo Custom (desde 2016); todos con motor EcoBlue TDCi ; AWD, FWD y RWD.

**FERRAMENTAS OEM**  
303-1637(1), 303-1650(2), 303-1643(3).

**CÓDIGOS DE MOTOR**  
BCCC,YLCB,YLDA,YLF6,YLFA,YLFB,YLFS,YLR6,YLRA,YM-CB,YMF6,YMFA,YMFB,YM-FS,YMHA,YMRA,YNCA,YNF6,YNFA,YNFB,YNFS,YNRA6,YNRA

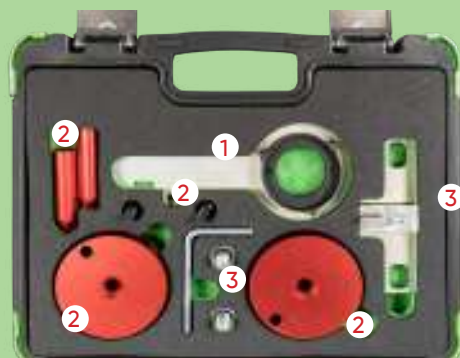

## KIT DE BLOQUEIO DE DISTRIBUIÇÃO PARA FORD

54201 37,60€

1,05 5 10 240  
Kg SUB

GASOLINA/PETROL

**MARCAS**  
Ford: C-MAX(07 - 10), C-MAX/Grand C-MAX(10-18), Fiesta(08-18), Focus/Focus C-MAX(04-11), Focus(11-18), Mondeo(07-15)

**FERRAMENTAS OEM**  
303-1097 (1), OEM 303-1054 (2), OEM 303-1059, 303-1270, 0188X, 999-7121 (3), OEM 303-748, 999-7152, 21-259 (4), OEM 303-735, 999 7122, 0187B, 0189B, 0132AJ1, 21-263, 0188M, MOT 1430, 303-1277, 0194B (5)

**CÓDIGOS DE MOTOR**  
11.6.TI-VCT HXDA (2003-2007), 2.0 TDCI , G6DA, G6DB, G6DC 2003-2007



## KIT DE BLOQUEIO DE DISTRIBUIÇÃO PARA FORD/MAZDA 2.2, 3.2 TDCI

54209 29,70€

0,85 5 10 240  
Kg SUB

GASOIL/DIESEL

**MARCAS**  
Ford\_Ranger 3.2L (2011-2016)  
Ford\_Ranger 2.2L (2011-2015)  
Ford\_Transit 2.2L (2006-2016)  
Ford\_Everest 3.2L (2015)  
Ford\_Ranger 3.2L (2011)

Mazda BT-50 (2011)  
Mazda BT-50 3.2L (2011-2016)

**FERRAMENTAS OEM**  
303-675/21-234,303-698/21-251 (1), 303-1587(2)

**CÓDIGOS DE MOTOR**  
CYFA,CYFB,DRFA,DRFB,P8FA,P8FB,PGFA,PGFB,QVFA,QWFA,SRFA,SRFB,SRFC,SRFD,SEFE,UHFA,CYFC,DRFC,USRA



## KIT DE BLOQUEIO DE DISTRIBUIÇÃO FORD 2.0 ECO BOOST SCTI& TI-VCT

54208 76,00€

1,95 - 5 135  
Kg SUB

GASOLINA/PETROL

**MARCAS**

FORD:  
Galaxy(2010)  
Mondeo (2010) S  
Max (2010)  
Focus(2011)

**FERRAMENTAS OEM**

303-748 (1),  
303-1504 (2),  
303-1565 (3),  
303-1521 (4)

**CÓDIGOS DE MOTOR**

TNWA,  
TNWB,  
TPWA,  
TNBA, TPBA,  
MGDA,  
XQDA



## KIT DE BLOQUEIO FORD 1.8TDDI / TDCI

53295 77,00€

GASOIL/DIESEL

2,10 - 5 165  
Kg SUB

**MARCAS**

C-Max (07-10), Courier (00-02), Fiesta (00-02), Focus (98-11), Focus C-Max (03-07), Galaxy (06-10), Mondeo (07-10), S-Max (06-14), Tourneo Connect (02-13), Transit Connect (02-13).

**FERRAMENTAS OEM**

303-193 (21-104) (1), 303-393 (21-168) (2), 303-376 (21-162B) (3), 303-652 (21-230) (4), 310-095 (23-067) (5)

**CÓDIGOS DE MOTOR**

1.8D TDCi: BHPA, F9DA, F9DB, FFBA, FFDA, FFWA, HCPA, HCPB, KHBA, KKDA, KKDB, P7PA, P9PA, P9PB, QYBA, QYWA, R2PA, R3PA, RWPA, RWPC.  
1.8D TDCi ECOnetic: KHBA.  
1.8D Tdi: BHDA, BHDB, BHPA, C9DA, C9DB, C9DC.  
1.8D Turbo: C9DC, RTN, RTP, RTQ.





## KIT DE BLOQUEIO FORD

53324 12,50€

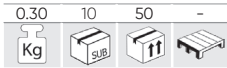

GASOLINA/PETROL



<b>MARCAS</b>	FORD: B-Max (15-17), C-Max (07-10), Cougar (98-01), Fiesta (95-17), Focus (98-11), Focus C-Max (03-07), Fusion (02-12), Galaxy (06-15), Maverick (01-07), Mondeo (93-15), Puma (97-02), S-Max (06-15), Tourneo Connect (02-06), Transit (06-12), Transit Connect (02-06). MAZDA: 121 ZQ (95-00), 2 DY (02-07), 3 BK (03-09), 3 BL (09-15), 5 CR (05-10), 5 CW (10-12), 6 GG/GY (02-07), 6 GH (07-15), MPV LW (02-05), MX-5 NC (05-16), Tribute EP (04-06). VOLVO: C30 (06-13), S40 (06-12), S80 (07-11), V50 (04-12).
<b>FERRAMENTAS OEM</b>	FORD: 303-1054, 303-507 (21-210), 303-620 (21-163), 303-574, 303-748, 303-376 (21-162B), 303-376B MAZDA: 49 JE01 061, 303-574, 49 JE02 061, 303-465, 49 JE01 054 VOLVO: 999 7152, 999 7151.
<b>CÓDIGOS DE MOTOR</b>	1.4 / 1.6

## KIT DE BLOQUEIO FORD / MAZDA

53294 119,00€

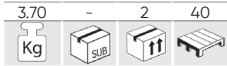

GASOIL/DIESEL

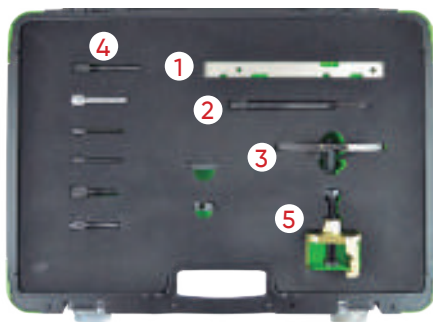

<b>MARCAS</b>	FORD: Courier (00-02), C-Max (03-10), Fiesta (02-11), Focus (98-11), Fusion (02-11), Galaxy (06-10), Kuga (06-10), Mondeo (07-10), S-Max (06-10), Tourneo Connect (02-13), Transit Connect (02-13). PEUGEOT: Bipper (08-10) Dispatch/Jumpy III (07-12) Expert III (07-12) Nemo (08-10) Partner I/II (05-11) Partner III (08-16) 107 (05-10) 1007 (05-10) 206 (01-12) 206+ (09-13) 206 CC (05-07) 207 (06-13) 207 CC (07-15) 208 (11-15) 307 (01-08) 308 (07-15) 308 CC (09-15) 407 (05-11) 508 (04-15) 2008 (13-15) 3008 (09-15) 4008 (12-15) 5008 (09-15). MAZDA: 2 (02-15), 3 (09-14). CITROËN: C1 (05-10), C2 (03-10), C3 I/II (02-10), C3 III (10-15), C3 Pluriel (04-10), C3 Picasso (09-12), C4 (04-11), C4 II (11-15), C4 Picasso (06-12), C4 Grand Picasso (10-12), DS3 (09-12), DS4 (11-12), DS5 (12-15), C5 II (04-08), C5 III (04-12), Xsara II (02-04), Xsara Picasso (04-10).
<b>FERRAMENTAS OEM</b>	FORD: 303-376B (1), 303-193 (2), 303-393 (3), 303-732 (4), 303-651 (5), 303-393/01, 303-1059, 303-734, 303-735. MAZDA: 303-732, 303-734, 303-735. PSA: 0194-A, 0194-C, 0194-B.
<b>CÓDIGOS DE MOTOR</b>	1.4D TDCi/HdI: DV4TD(8HT), DV4TD(8HX), DV4TD(8HZ), DV4TD(8HW), DV4TED4(8HX), DV4TED4(8HV), DV4TED4(8HY), DV4C(8HP), DV4C(8HR), DV4TED(8HS), F6JA, F6JB, F6JC. 1.6D TDCi/HdI: DV6TED4(9HZ), DV6ATED4(9HX), DV6TED4(9HY), DV6DTED(9HP), DV6C(9HR), DV6CATED(9HX), DV6C(9HL), DV6TED(9HP), DV6ATED(9HY), DV6TED4(9HV), DV6TED4(9HX), DV6C(9HD), DV6C(BHX), DV6C(BHZ), DV6(9HR), DV6BTED4(9HW), DV6DTED(9HJ), DV6ETED(9HN), DV6TED4BU(9HS), DV6BTED4(9HT), DV6BUTED4(9HT), DV6TED4B(9HV), DV6UTED4(9HX), DV6TED(9HD), DV6UTED4(9HU), DV6D(9HP), DV6TE-D4(9HV), DV6C(9HD), DV6TED4(9HW), DV6AT(9HX), DV6ATED(9HX), DV6CTED(9HC), DV6AUTED4(9HX), DV6TED4B, DV6DTED(9HF), HHJA, HHJB, G8DA, G8DB, HHDA, HHDB, MZ-CD, Y6. 1.8D TDCi/HdI: BHPA, C9DA/B, FFBA, G6DA, G6DB, G6DC, HCPA, HCBP, KKDA, P7PA, P9PA, R2PA, R3PA, RWPA. 1.8ci: C9DC, RTN, RTQ. 1.8D Tdi: C9DA/B, C9DC. 2.0D TDCi/HdI: AZWA, G6DA, G6DB, G6DC, RHE(DW10CTED4), QXWA, QXWB.

## KIT DE BLOQUEIO PARA BOMBA DE INJEÇÃO FORD E JAGUAR DURATORQ

53296 60,00€

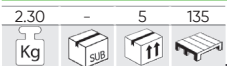

GASOIL/DIESEL

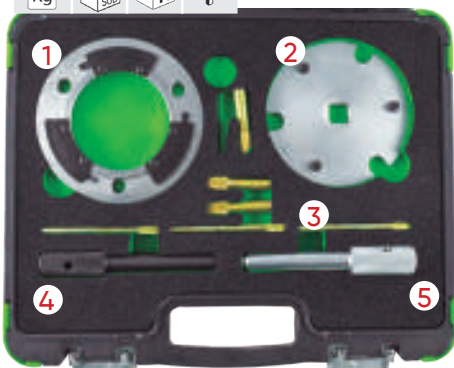

<b>MARCAS</b>	FORD: Mondeo (00-07), Transit (00-14). CITROËN: Relay/Jumper III (06-13). FIAT: Ducato (06-11). JAGUAR: X-Type (03-10). PEUGEOT: Boxer III (06-12). LAND ROVER: Defender Td4 (06-11). LDV: Convoy (02-06).
<b>FERRAMENTAS OEM</b>	303-1151 (1), 303-679A/21-238 (2), 303-732 (3), 303-675/21-234 (4), 303-698/21-251 (5)
<b>CÓDIGOS DE MOTOR</b>	12.0D Di/TDci/TDCi: ABFA, D3FA, F3FA, D5BA, D6BA, F1FA, FMBA, FMBB, HJBA, HJBB, HJBC, HJBE, N7BA, N7BB. 2.2D TDCi/ECONetic: BG, CYFA, CYFB, CYFC, DRFA, DRFB, DRFC, P8FA, P8FB, PGFA, PGFB, QJBA, QJBA (BG), QJBB, QJBC, QJBD, QVFA, QWFA, SRFA, SRFB, SRFC, SRFD, SRFE, UHFA. 2.2D HdI/JTD: P22DTE (4HM), P22DTE (4HU), P22DTE (4HV). 2.4D Di/TDCi: DOFA, D2FA, D2FB, D4FA, F4FA, FXFA, H9FA, H9FB, H9FD, JXFA, JXFC, PHFA, PHFC. 2.4D TD/Tdi: ZSD 424. 2.4D Tdi: 244DT.

## KIT DE BLOQUEIO JAGUAR / LAND ROVER

53297 45,00€

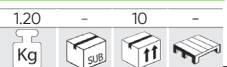

GASOIL/DIESEL

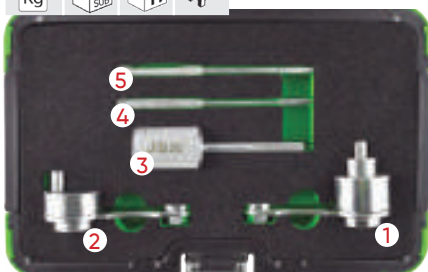

<b>MARCAS</b>	JAGUAR: MS TypeTDVi. LAND ROVER: Discovery 2.7 TDV6. RANGE ROVER: Sport 2.7 TDV6.
<b>FERRAMENTAS OEM</b>	303-1117 (1), 303-1116 (2), 303-1132 (3), 303-1126 (4) (5)
<b>CÓDIGOS DE MOTOR</b>	276DT, 306DT.

IVA não incluído

## KIT DE BLOQUEIO LAND ROVER

53298 91,00€

2.60 - 5 160  
Kg SUB

GASOIL/DIESEL

### MARCAS

MOTOR DIESEL: 200 TDI. 300 TDI. 2.5

- Pino de sincronização de transmissão manual.
- 200 tdi. 300 tdi. 2.5 motores diésel.
- Extrator de amortecedor de cambota.
- Ferramenta de bloqueio da bomba de injeção.
- Perno de sincronização da bomba de injeção 200/300 tdi.
- Ferramenta de sincronização do volante do motor 200/300 tdi.
- Ferramenta de sincronização da bomba dsp 2.5.
- Ferramenta de sincronização do volante do motor 2.5.



## KIT DE BLOQUEIO OPEL / FORD / FIAT / ALFA ROMEO / LANCIA / SUZUKI

53452 26,50€

0.80 5 10 240  
Kg SUB

GASOIL/DIESEL

### MARCAS

VAUXHALL/OPEL 1.3 CDTi: Agila, Corsa, Combo (03-08), Astra-H(05-08), Meriva, Tigra-B(04-08)  
SUZUKI 1.3 DDiS: Ignis, Wagon R(03-08), Swift(04-08)  
FORD: 1.3 TDCi  
FIAT/ALFA ROMEO/LANCIA: 1.3 JTD Multijet

### FERRAMENTAS OEM

104-A EN 46781 (1), EN 46785 (2)

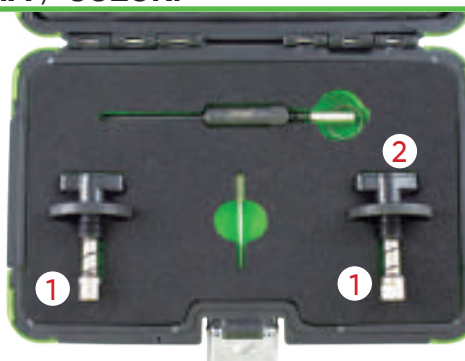

## KIT DE BLOQUEIO OPEL / VAUXHALL / CHEVROLET 2.0CDI

53300 41,00€

1.25 - 10 270  
Kg SUB

GASOIL/DIESEL

### MARCAS

OPEL  
VAUXHALL  
CHEVROLET

### FERRAMENTAS OEM

EN-48245 (1), EN-48246 (2),  
205083060 (3) (4) (5) (6)

### CÓDIGOS DE MOTOR

OPEL / VAUXHALL: Z20DM,  
Z20DMH  
CHEVROLET: LLWZ20DMH,  
RA 420, Z20SI, Z 20S3, Z  
20S4, Z 20S5

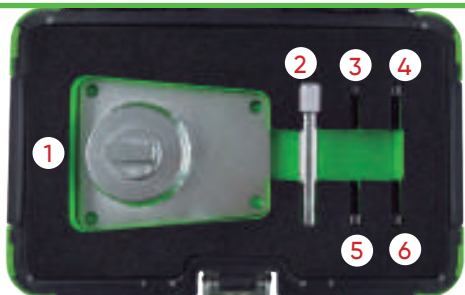

## KIT DE BLOQUEIO OPEL / VAUXHALL

53299 291,00€

6.70 - 2 42  
Kg SUB

GASOIL/DIESEL

### MARCAS

OPEL /  
VAUXHALL

### FERRAMENTAS OEM

EN-46788 (1), KM927 (2), EN-46789 (3), KM929 (4), EN-46785 (5), EN-46788 (6), 1 860 985 000 (7), KM932 (8), KM933 (9), EN-49978 (10), KM933 (11)

### CÓDIGOS DE MOTOR

1.3 CDTi 16V, 1.9 CDTi, 2.0 DTi,  
2.2 DTi.



## KIT DE BLOQUEIO DE DISTRIBUIÇÃO PARA FIAT, OPEL, ALFA 1.9, 2.4L 16V

54216 49,00€

1.75 - 5 135  
Kg SUB

GASOIL/DIESEL

### MARCAS

Opel 1.9, Alfa-Romeo 1.9-2.4 L diesel, Fiat 1.9- 2.4 L diesel

### FERRAMENTAS OEM

Opel EN-46788 / Fiat 1.860.905.000 / 1.860.905.010 (1)  
Fiat 1.860.898.000 (2)  
Opel EN-46789 / Fiat 1.870.896.900 (3)  
Opel KM 6130 / KM 6349 (4)

### CÓDIGOS DE MOTOR

Opel 1.9 CDTi Z19DT, Z19DTH, Z19DTJ  
Alfa-Romeo 1.9 y 2.4 L : 323.02, 371.01, 342.02, 325.01, 362.02, 182B9.000, 937A2.000, 937A3.000, 192A5.000, 192B1.000, 937A4.000, 937A5.000, 939A2.000, 939A1.000, 939A7.000, 939A8.000, 839A6.000, 841C.000  
Fiat 1.9 y 2.4 L : 182B4.000, 182B9.000, 185A6.000, 186A6.000, 186A8.000, 186A9.000, 188A2.000, 188A7.000, 188B2.000, 192A1.000, 192A3.000, 192A5.000, 192A8.000, 192A9.000, 192B4.000, 192B5.000 198A2.000, 198A3.000, 198A6.000, 199A5.000 223A7.000, 937A5.000, 939A1.000, 939A2.000 939A3.000, 939A7.000





# KIT DE BLOQUEIO AUDI / OPEL / VAUXHALL 1.0 1.2 1.4 TURBO

53651

91,00€

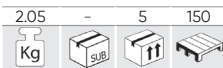

GASOLINA/PETROL



<b>MARCAS</b>	OPEL: Adam, Ampera, Astra-J, Aveo, Corsa-D, Insignia, Meriva-B, Mokka, Zafira-C Tourer
<b>FERRAMENTAS OEM</b>	EN 49977-100 (1), EN 49977-200 (2), EN 49978 (3), KM 952 (4), KM 953-A (5), KM 955-1 (6), KM 955-2 (7).
<b>CÓDIGOS DE MOTOR</b>	10: A10XEP (LDB) 12: A12XEL (LWD), A12XER (LDC) 14: A14XEL (L2Z), A14XER (LDD), LDU A14NEL (LUH), A14NET (LUJ), Twinport / ecoFLEX engines A14XFL (LUU), A14NEL (LDD), A14NEL (LUJ), A12XEL (L2Q)

# KIT DE BLOQUEIO OPEL 1.0 / 1.2 / 1.4

53301

44,00€

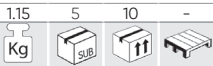

GASOLINA/PETROL

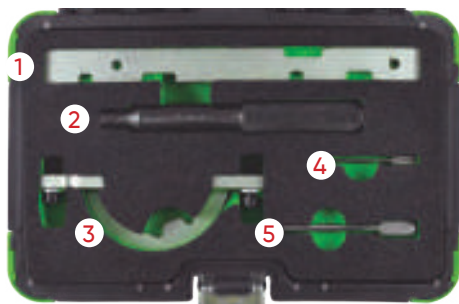

<b>MARCAS</b>	SUZUKI: Wagon R (05-08). VAUXHALL / OPEL: Agila (00-08), Astra-G (98-06), Astra G Classic II (03-10), Astra-H (04-11), Combo (04-12), Corsa-B (97-00), Corsa-C (00-07), Corsa-D (06-12), Meriva-A (04-10), Tigra-B (04-10).
<b>FERRAMENTAS OEM</b>	KM-953/09919-58310 (1), KM-952/09912-38310 (2), KM-954/09919-08310 (3), KM-6130 (4), KM-955/09919-58320 (5)
<b>CÓDIGOS DE MOTOR</b>	1.0 12v: X10XE, Z10XE, Z10XEP. 1.2 16v: X12XE, Z12XE, Z12XEP. 1.4 16v/ecoFLEX: Z14XEL, Z14XEP.

# KIT DE BLOQUEIO DE DISTRIBUIÇÃO PARA VAUXHALL, OPEL 1.3 CDTI

54221

111,00€

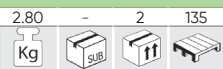

GASOIL/DIESEL



<b>MARCAS</b>	Vauxhall/ Opel 1.3 CDTI Corsa E Diesel Engine From 2015
<b>FERRAMENTAS OEM</b>	KM-662-C(1), EN-50515(2), EN-51500(3), EN-46775(4), KM-955-1(5), EN-46785.(6)
<b>CÓDIGOS DE MOTOR</b>	LKU B13DTE, LKU B13DTR

# KIT DE BLOQUEIO DE DISTRIBUIÇÃO PARA VAUXHALL, OPEL, SAAB 2.0, 2.2 DTI

54217

104,00€



GASOIL/DIESEL



<b>MARCAS</b>	Vauxhall/Opel: Astra-G (98-06), Frontera-B (98-04), Omega-B, (98-03), Signum (03-05), Sintra (98-99), Vectra-B (97-02), Vectra-C (02-05), Zafira-A (99-05), Saab: 9-3 (98-04), 9-5 (02-06)
<b>FERRAMENTAS OEM</b>	Saab: 83 95 394(1), 83 95 337 (2), 83 95 352(3), 83 95 386(4)Vauxhall/Opel/ Saab: KM-927(2), KM-929(3), KM-932 (4), KM-933(1)
<b>CÓDIGOS DE MOTOR</b>	Opel: X20DTH, X20DTL, Y20DTH, Y20DTL, X22DYH, Y22DTH, Y22DTR Saab: D223L

## KIT DE BLOQUEIO FIAT / OPEL

**53303** 89,00€

**GASOIL/DIESEL**



<b>MARCAS</b>	FIAT: 1.9D / JTD (Motor Peugeot), 2.4D. ALFA ROMEO: 145, 146, 156 JTD. GM: GM 1.3, 1.6, 1.9, 2.0, 2.4 CDTI (2004 -).
<b>FERRAMENTAS OEM</b>	EN-46789 (1), EN-46789-100 (2), EN-46785 (3), EN-46788 (4), EN-46781 (5), EN-46789 (6)
<b>CÓDIGOS DE MOTOR</b>	GM: K1.3 CDTI   Z13DT Common Rail engine. 1.9 CDTi / 04-12 - Z19DT   Z19DTH   Z19DTJ   Z19DTL 2.0 CDTi / 08-12 - A20DT   LBS / LBX / LBY / LCD.V SAAB: 1.9 T1D.



## KIT DE BLOQUEIO OPEL / VAUXHALL ASTRA, VECTRA, ZAFIRA 1.9CDTI

**53302** 44,00€

**GASOIL/DIESEL**

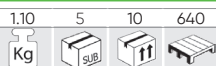

<b>MARCAS</b>	SAAB: 9-3 (04-08), 9-5 (05-08). VAUXHALL / OPEL: Astra-H, Vectra-C, Signum (04-07), Zafira-B (05-07).
<b>FERRAMENTAS OEM</b>	EN46789/32 025 008 (1) (3), EN46788/32 025 009 (2), KM6349 (4)
<b>CÓDIGOS DE MOTOR</b>	Z19DT, Z19DTH, Z19DTL.

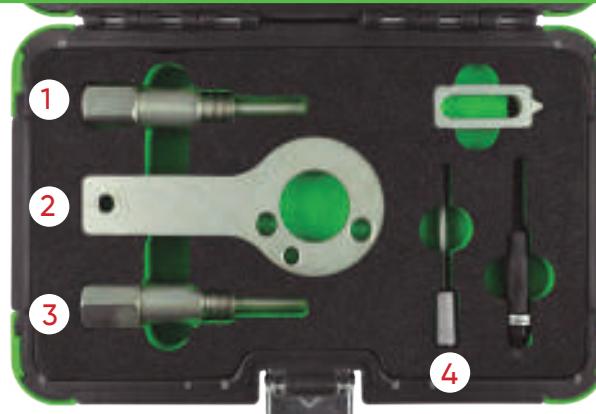

## KIT DE BLOQUEIO SAAB / OPEL / VAUXHALL

**53305** 136,00€

**GASOLINA/PETROL**



<b>MARCAS</b>	VAUXHALL / OPEL: Antara (06-10), Calibra (93-98), Cavalier/Vectra-A (93-95), Omega-B (94-03), Signum (03-05), Sintra (96-99), Vectra-B (95-02), Vectra-C (02-05). SAAB: 900 (93-98), 9000 (95-97), 9-5 (98-03)
<b>FERRAMENTAS OEM</b>	KM-800-1 (1), KM-800-2 (2), KM-800-20 (3), KM-800-10 (4), 83 95 006 (5), KM-800-30 (6), MKM-6038, 83 95 006 (7)
<b>CÓDIGOS DE MOTOR</b>	2,5 V6: Saab; B2581, Vauxhall/Opel; C25XE, X25XE. 2,6 V6: Vauxhall/Opel; Y26SE. 3,0 V6: Saab; B308E, B308i, Vauxhall / Opel; X30XE. 3,2 V6: Vauxhall/Opel; Y32SE, .

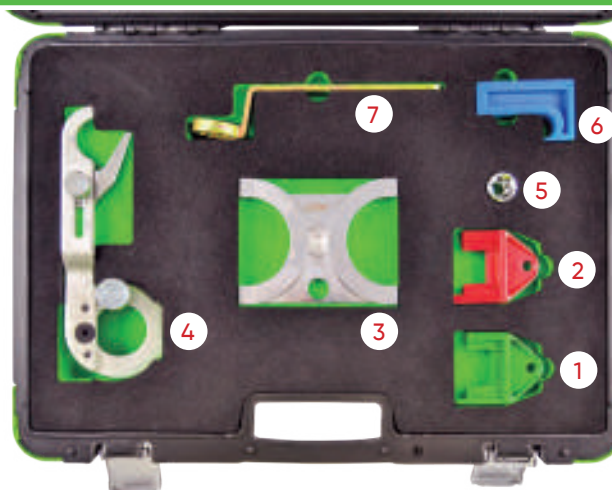

## KIT DE BLOQUEIO FIAT

**53304** 279,00€

**GASOLINA/PETROL**

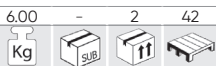

**GASOIL/DIESEL**

<b>MARCAS</b>	FIAT
<b>FERRAMENTAS OEM</b>	1 860 874 000 (1), 1 860 895 000 (2), 1 860 898 000 (3), 1 860 905 000 (4), 1 860 845 000 (5)
<b>CÓDIGOS DE MOTOR</b>	<b>MOTOR GASOLINA:</b> Fiat Brava , Bravo, Barchetta, Cargo, Coupe, Marea, Palio, Weekend, Punto, Multila, Stilo, Idea, Doblo Twin Cam Engines - 1.2, 1.4, 1.6, 1.8, 1.6V <b>MOTOR DIESEL:</b> Fiat Brava, Bravo, Marea, Weekend, Palio, Punto, Multipla, Doblo, Ulysse, Ducato, Stilo JTD Diesel Engines - 1.9JTD . 1.9JTD . 2.4TD/JTD.

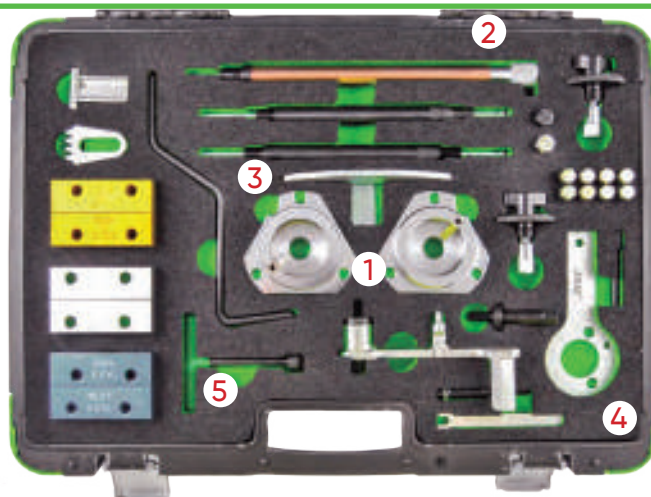



## KIT DE BLOQUEIO ALFA / OPEL / VAUXHALL 1.6 / 1.8 16V

53307 38,50€

GASOLINA/PETROL

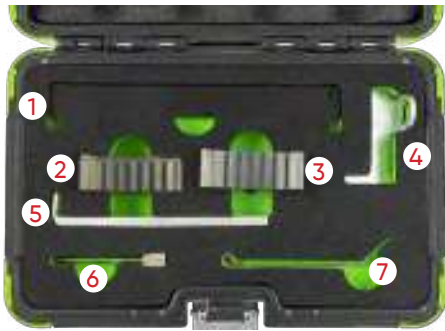
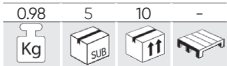

<b>MARCAS</b>	OPEL / VAUXHALL: Corsa-D, Agila, Astra-G-H, Meriva, Zafira-B, Vectra-C, Signum, Insignia	1,6, 1,8
	CHEVROLET: Aveo, Cruze, Orlando	1,4, 1,6, 1,8
	ALFA ROMEO: 159 FIAT: Croma	1,8
<b>FERRAMENTAS OEM</b>	E10290 (1), 23056-06 (2) (3), E10230 (4), 23164-04 (5), 23174-01 (6), 23056-05 (7)	
<b>CÓDIGOS DE MOTOR</b>	OpeL / Vauxhall: Z16LEL, Z16LER, Z16LET, Z16XE1, Z16XEP, Z16XER, A16XER, 18XER, A18XER, 2HO/A18XEL. Chevrolet: G14D, LDD, LXV (F16D4), 2HO(Z18XER). Alfa / Fiat: 939A4.000.	

## KIT DE BLOQUEIO FIAT / OPEL / VAUXHALL 2.2 16V CADEIA

53316 34,00€

GASOLINA/PETROL

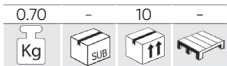

<b>MARCAS</b>	OPEL: Astra-G (2000-2006), Astra-H (2006-2011), Signum (2003-2008), Vectra-B (2000-2002), Vectra-C (2002-2008), Zafira-A (2000-2005), Zafira-B (2005-2012), Speedster (2000-2006). VAUXHALL: VX220 (2000-2006). FIAT: Croma (2005-2009).	
<b>CÓDIGOS DE MOTOR</b>	VAUXHALL / OPEL: Z22SE, Z22YH FIAT: 194A1.000.	

## KIT DE BLOQUEIO DE DISTRIBUIÇÃO PARA VAUXHALL/ OPEL 1.6 CDTI

54205 49,00€

GASOIL/DIESEL

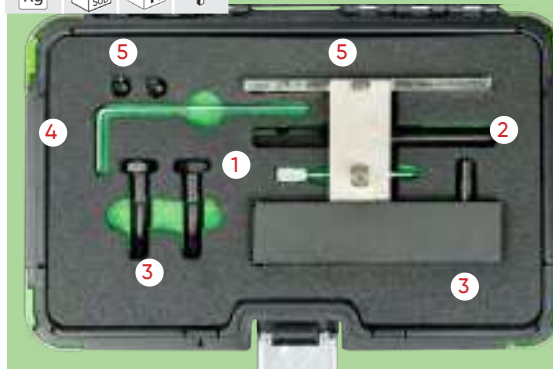

<b>MARCAS</b>	Vauxhall/Opel: Astra J (13-18), Astra K, (15-19), GTC (15-18), Insignia A (15-17), Insignia- B (17-20), Meriva B (13-17), Mokka (14-16), Mokka X (16-20), Zafira C Tourer (13-19).	
<b>FERRAMENTAS OEM</b>	EN-6349, EN-6130 (1), EN-51143 (2), EN-51140 (3), EN-50513 (4), EN-51188 (5)	
<b>CÓDIGOS DE MOTOR</b>	B16DTC, B16DTE, B16DTH, B16DTJ, B16DTL, B16DTN, B16DTR and B16DTU. D16DTH, D16DTI, D16DTJ, D16DTN, D16DTR, D16DTU	

## KIT DE BLOQUEIO DE DISTRIBUIÇÃO PARA 1.6D, 1.7D E ISUZU

54214 96,00€

GASOIL/DIESEL

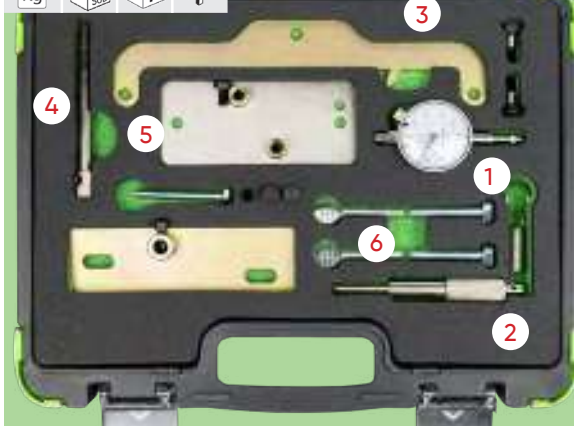

<b>MARCAS</b>	ASTRA, CAVALIES, VECTRA-A(87-00), ISUZU, NOVA, CORSA / COMBO, STRA, CAVALIER, VECTRA, FRONTERA, MONTEREY, MIDI, BRAVA (88-04)	
<b>FERRAMENTAS OEM</b>	VAS 6079 (1), KM 951 (2), KM 851 (3), 23-029 (4), KM 661-2 (5), KM 661 (6)	
<b>CÓDIGOS DE MOTOR</b>	OPEL : 16DA, 17D, 17DR, X17DTL ISUZU : 4EC1, 4EE1, 4JB1, 4XJ1, 4JA1, 4JG1, 4FC1, 4FD1, 4FG1, Z17DT, Y17DT/DTL	

## KIT DE BLOQUEIO CITROËN / PEUGEOT

53313 139,00€

GASOLINA/PETROL

4,55	-	2	40
Kg	Sub	Box	Tray

GASOIL/DIESEL

### MARCAS

CITROËN: AX, BX, Boxer, Berlingo, C25, Dispatch, Evasion, J5, Jumpy, Jumper, Relay, Saxo, Synergie, Visa, XM, Xsara, Xantia, XZ, ZX.  
PEUGEOT: 106, 205, 206, 305, 306, 307, 309, 405, 406, 605, 607, 806, Expert, Partner, Solara, Talbot.

### FERRAMENTAS OEM

7099TM (1), 0188X (2), 0188P (3), 0189AZ (4), 0188H (5), 0132AJ1 (6), 0189A (7), 0188PM (8), 21-260 (9), 4527-TS1 (10), M8X70 (11), 0188K (12), 0188J (13), 0132Q (14), 4507-TL (15), 4507-TJ (16), 9044-T (17), 4507-TJ (18), 5711-TA (19), 7014-TJ (20), 7017-TR (21), 0188X (22), 7017-TW (23), 7014-TM (24), 0189L (25)

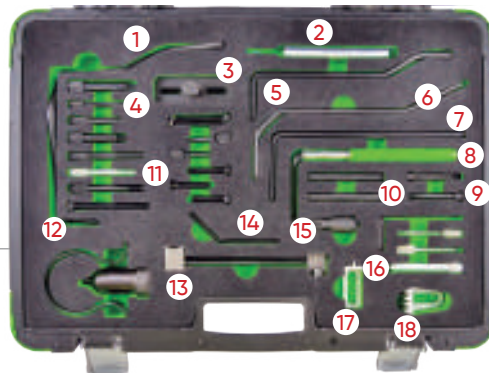

## KIT DE BLOQUEIO CITROËN / PEUGEOT 1.8 / 2.0

53314 98,00€

GASOLINA/PETROL

1,85	-	2	-
Kg	Sub	Box	Tray

### MARCAS

CITROËN: C4 Picasso/Grand Picasso (06-10), C5 II (04-08), C8 (05-10), Dispatch/Jumpy (07-11), Xsara 2.0 16v, C5 1.8/2.0/HPI, Xsara Picasso 1.8/2.0 16v (02-05)  
PEUGEOT: 406 1.8 16v (00-04), 407 (06-10), 807 2.0 16v (02-05).

### FERRAMENTAS OEM

0189S2 (1), 0188J (2), 0188J2 (2), 0189S1 (3), 21-260 (4), 0189B (5), 0188M (6), 0188AH (7), 0189R (8)

### CÓDIGOS DE MOTOR

1.8 16v: EW7A(6FY).  
2.0 16v: EW10A(RFJ), EW10ABE4(RFH), EW10J4S (RFK).

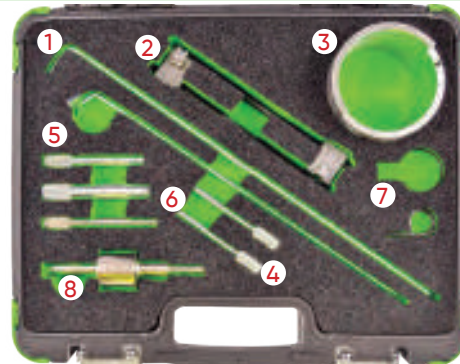

## KIT DE BLOQUEIO RENAULT / NISSAN / OPEL / VAUXHALL 2.0 / 2.3 DCI / CDTI M9R / M9T

53311 97,00€

GASOIL/DIESEL

2,55	-	5	135
Kg	Sub	Box	Tray

### MARCAS

NISSAN: Primastar X83 (06-15), Qashqai/Qashqai+2 J10 (07-14), X-Trail T31 (07-14).  
VAUXHALL/OPEL: Movano-B (10-17), Vivaro (06-15).  
RENAULT: Espace/Grand Espace IV (06-10), Koleos (08-15), Laguna II (05-07), Laguna III (07-14), Master III (10-15), Megane II (06-10), Scenic/Grand Scenic II (06-09), Scenic/Grand Scenic III (09-15), Trafic II (06-14), Vel Satis (05-10)

### FERRAMENTAS OEM

Mot1769 (1), EN-48334 (2), Mot1766 (3), EN-48330 (3), KM-6130 (4), EN-48332 (5), Mot1773 (6), EN-48831 (6)

### CÓDIGOS DE MOTOR

2.0D dCi M9R: 630, 780, 782, 784, 786, 788, 830, 832, 833, 834, 835, 836, 838, 855, 856.  
2.0D CDTI M9R: 630, 780, 782, 784, 786.  
2.3 Bi-CDTI: LP6/M9T706, LW7/M9T706.  
2.3D dCi M9T: 670, 672, 676, 678, 680, 686, 690, 692, 694, 698.



## KIT DE BLOQUEIO CITROËN/PEUGEOT 1.0/1.2 VTI

53876 64,00€

GASOLINA/PETROL

1,80	-	5	120
Kg	Sub	Box	Tray

### MARCAS

CITROËN: C3 (III)  
PEUGEOT: 208, 308, 2008 SUV (2012-2014)

### FERRAMENTAS OEM

0109-2A (1),  
0109-2B (2)

### CÓDIGOS DE MOTOR

1.0/1.2 VTI.  
EBO, (ZMZ), EB2, (HMZ)

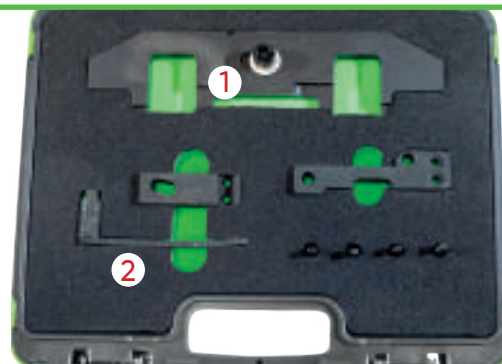

## KIT DE BLOQUEIO DE DISTRIBUIÇÃO PARA ROVER, PEUGEOT, FORD, VOLVO 2.0/ 2.2L D

54213 19,80€

GASOIL/DIESEL

0,40	6	24	240
Kg	Sub	Box	Tray

### MARCAS

Peugeot: 807 (05-11), 407 (05-11), 607 (05-09). Citroën: C4 (04-10), C5 II (04-10). Land Rover: Freelander (06-10). Volvo: S40 (03-10), V50 (06-10), C70 (06-10), S80 (07-10), C30 (06-10), V70 (07-10). Ford: S Max 2.2 (08-10), Galaxy 2.2 (08-10), Mondeo 2.2, 2.0 (07-10).

### FERRAMENTAS OEM

PSA 0188.M, Ford 303-735, 303-1277, Volvo 999-7122 (1)  
PSA 0188.X, Ford 303-1059, 303-1270, Volvo 999-7121 (2)  
PSA 0188.F, Ford 303-393A, 303-393-01, 303-1272, Volvo 999-7119/7120 (3)

### CÓDIGOS DE MOTOR

PEUGEOT: DW10UTED4 (RHK), DW10BTED4 (RHR), DW12BTED4 (4HS), (4HP), (4HT), (4HR).  
Citroën: DW10BTED4 (RHR). LAND ROVER: DW12BTED4, 224DT. Volvo: D420T 2.0D. FORD: QXBA(2.2), QXWA(2.0), QXBB(2.0), Q4BA(2.2), QXWA(2.0), QXWB(2.0), AZBA(2.0), AZBC(2.0), AZWA(2.0)

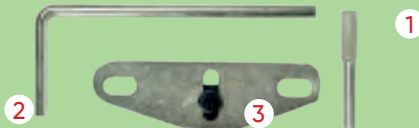



## KIT DE BLOQUEIO FIAT / ALFA / LANCIA



<b>MARCAS</b>	ALFA FIAT LANCIA	Alla, Barchetta, Bravo, Brava, Coupe, Delta, Dedra, Punto, Spider, GT
<b>FERRAMENTAS OEM</b>	1860845000 (1), 1822154000 (2), 1860905000 (3), 1860992000 (4), 1860895000 (5), 1860874000 (6), 1860985000 (7), KM571A (8), 1 860 896 000 (9), 0153A (10)	
<b>CÓDIGOS DE MOTOR</b>	1.2 / 16V, 1.4 / 12V, 1.6 / 16V, 1.6 eco, 1.8, 2.0 / 16V, 2.0 / 20V, 2.4 / 20V, 3.0 / V6.	

## KIT DE BLOQUEIO FIAT/ALFA/LANCIA 1.2 16V, 1.4 16V, T-JET



<b>MARCAS</b>	Alfa Romeo: Giulietta (10-14), MiTo (08-17), Fiat: 500 (07-19), 500L (12-19), 500C (07-19), 500 Abarth (08-17), Bravo (07-14), Brava/Bravo (98-02), Doblo/Doblo Cargo (10-19), Egea (15-20), Grande Punto (07-10), Grande Punto Abarth (07-10), Idea (04-12), Linea (07-10), Marea/Weekend (98-00), Palio Weekend (01-06), Panda (07-11), Punto (97-08), Stilo (01-08), Tipo (15-20), Lancia: Delta (08-12), Musa (04-13), Ypsilon (96-11).	
<b>FERRAMENTAS OEM</b>	2.000.004.500 (1), 1.860.985.000 (2), 1.860.992.000 (3), 1.860.987.000 (4), 2.000.015.800 (5)	
<b>CÓDIGOS DE MOTOR</b>	1.2 16v:176B9.000, 182B2.000, 188A5.000. 1.4 16v / T-Jet: 169A3.000, 192B2.000, 198A1.000, 198A4.000, 199A6.000, 198A8.000, 312A1.000, 312A3.000, 843A1.000, 955A1.000.	

## KIT DE BLOQUEIO FIAT / ALFA / FORD



<b>MARCAS</b>	FIAT: New 500 (07-09), Idea (04-09), Linea (07-09), Grande Punto (07-09), Doblo 1 Cargo (05-09), Panda EV02 (05) FORD: KA 1.2 Duratec (09) ALFA ROMEO	
<b>FERRAMENTAS OEM</b>	1 860 987 000 (1), 2 000 004 400 (2), 2 000 015 800 (3), 2 000 004 300 (4), 2 000 004 500 (5)	
<b>CÓDIGOS DE MOTOR</b>	1.2: 169A4.000 / 199A4.000. 1.4: 350A 1.000 / 188A4.000-EV02.	

## KIT DE BLOQUEIO DE DISTRIBUIÇÃO PARA ALFA ROMEO, LANCIA 1.75 TBI



<b>MARCAS</b>	Alfa Romeo: 159(09-12), Brera(09-11), Giulietta(10-19), Spider(09-11), 4C(13-19). Lancia: Delta(09-14).	
<b>FERRAMENTAS OEM</b>	2 000033500 (1), 2000 003000 (2), 1860898 000 (3).	
<b>CÓDIGOS DE MOTOR</b>	Alfa Romeo 1,75 Tbi: 939B1.000, 940A1.000, 940B2.000, 960A1.000 Lancia 1,75 DI Turbo Jet: 939B1.000	

## KIT DE BLOQUEIO FIAT 1.2 16V

53306 53,00€

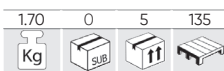

GASOLINA/PETROL

<b>MARCAS</b>	FIAT: Fiat 1.2L 16V, Fiat Punto / Brava / Bravo / Stilo
<b>FERRAMENTAS OEM</b>	1860992000 (1) (2), 1871000900 (3), 1860987000 (4), 186985000 (5)
<b>CÓDIGOS DE MOTOR</b>	176 B9.000, 182 B2.000, 188 A5.000



## KIT DE BLOQUEIO FIAT / IVECO 2.3 / 3.0 JTD

53319 18,00€

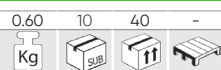

GASOIL/DIESEL

<b>MARCAS</b>	FIAT: 2.3 / 3.0 JTD. IVECO: Daily.
<b>FERRAMENTAS OEM</b>	99360614, 1 860 617 000, 99360615, 2 000 018 200.
<b>CÓDIGOS DE MOTOR</b>	F1AE0481C, F1AE0481D, F1AE0481N, F1CE0481A/D.

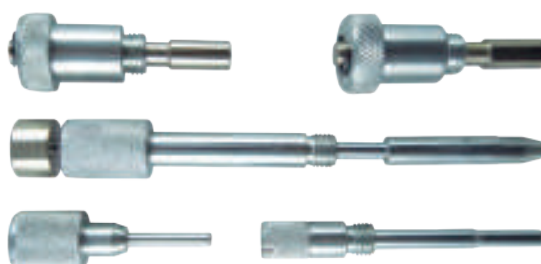

## KIT DE BLOQUEIO ALFA / FIAT / LANCIA 1.4 / 1.6 / 1.8 / 2.0 16V

53309 285,00€



GASOLINA/PETROL

<b>MARCAS</b>	ALFA ROMEO: 145/146/147/155/156, 1.4 1.6 1.8 2.0 TS, 1.4/1.6 16V; 145/146/147/155/156 (96-10), 1.8 16V; 145/146 (96-01), 155/156 (96-06), Spider/GTV (98-05), 2.0 16V; 145/146 (96-01), 147 (01-10), 155/156 (95-02), 166 (98-07), Spider/GTV (96-05), Purpur: 1.4, 1.6 // Blau: 1.8, 2.0 FIAT: Barchetta (96-00), Brava (95-00), Bravo (95-00), Coupe (96-01), Marea (96-00), Marea Weekend (96-00), Punto/Punto Classic (99-06), Stilo (01-08) LANCIA: Dedra (95-99), Delta (96-99), Kappa (98-02), Lybra (99-06).
<b>CÓDIGOS DE MOTOR</b>	1.4 16v: 335.03 1.6 16v: 321.02, 321.03, 321.04, 372.03, 676.01 1.8 16v: 322.01, 322.05, 671.06, 182A2.000, 183A1.000, 183A6.000, 188A6.000, 192A4.000 2.0 16v: 162.01, 323.01, 323.1, 341.03, 363.01, 672.04 2.0 20v: 175A3.000, 182A1.000, 182B7.000, 185A8.000.



## KIT DE BLOQUEIO DE DISTRIBUIÇÃO PARA FIAT, LANCIA 1,4 12V

54212 39,40€

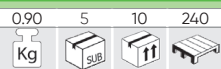

GASOLINA/PETROL

<b>MARCAS</b>	Marea/Marea Weekend(96-20), Brava(95-98), Bravo(95-98). Lancia: Ypsilon(96-20)
<b>FERRAMENTAS OEM</b>	1860899000 (1), 1860901000 (2)
<b>CÓDIGOS DE MOTOR</b>	1.4 12v : 182A3.000, 182A5.000.

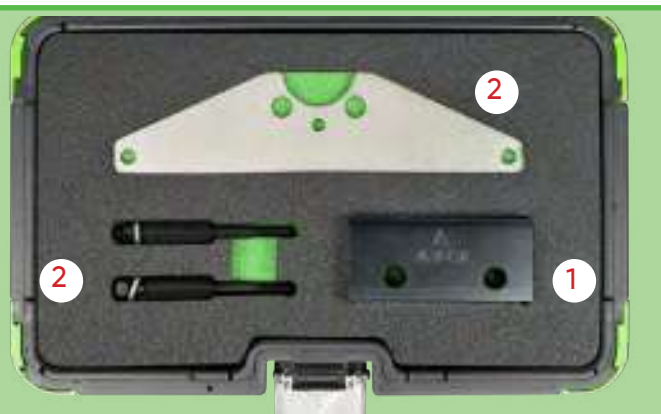



## KIT DE BLOQUEIO ALFA ROMEO

53308

55,00€

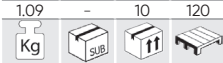

GASOLINA/PETROL

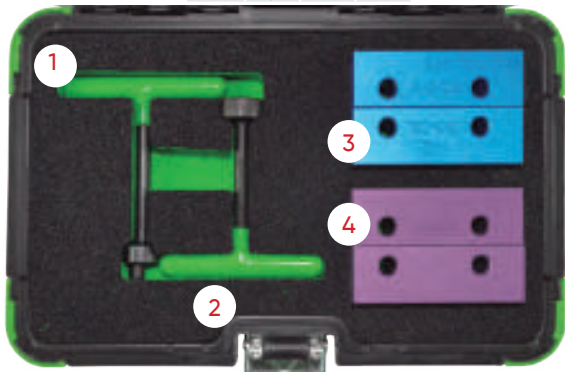

<b>MARCAS</b>	ALFA ROMEO: 145,146,147,155,156, 1.4 1.6 1.8 2.0 TS, 1.4/1.6 16V; 145/146/147/155/156 (96-10), 1.8 16V; 145/146, (96-01), 155/156 (96-06), Spider/GTV (98-05), 2.0 16V; 145/146 (96-01), 147 (01-10), 155/156 (95-02), 166 (98-07), Spider/GTV (96-05), Púrpura / Purple: 1.4, 1.6 // Azul / Blue: 1.8, 2.0
<b>FERRAMENTAS OEM</b>	1822149000 (1), 1822154000 (2), 1825041000 (3), 1825042000 (4)
<b>CÓDIGOS DE MOTOR</b>	Z1.4/1.6-321.02, 321.03, 321.04, 335.03, 676.01 1.8/2.0-323.01, 672.04, 162.01, 323.10, 671.06, 322.01, 671.02, 322.05, 341.03, 363.01.

## KIT DE BLOQUEIO ALFA ROMEO , FIAT 1.4 MULTI AIR

54215

57,00€

GASOLINA/PETROL

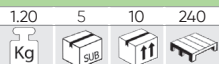

<b>MARCAS</b>	Alfa Romeo Giulietta, Mito / Fiat Punto, Punto Evo 1.4 (Turbo) MultiAir (105/135/163/170PS)
<b>FERRAMENTAS OEM</b>	Alfa Romeo / Fiat: 1860987000 (1), 2000034400 (2), 2000004500 (3)
<b>CÓDIGOS DE MOTOR</b>	940A2.000 / 940A2.000 / 955A8.000 / 955A8.000 / 940A2.000 / 955A8.000 / 955A2.000 / 955A7.000 / 955A6.000 / 955A8.000

## KIT DE BLOQUEIO FIAT / ALFA / LANCIA / OPEL / SUZUKI / FORD

53773

298,00€

GASOLINA/PETROL

GASOIL/DIESEL

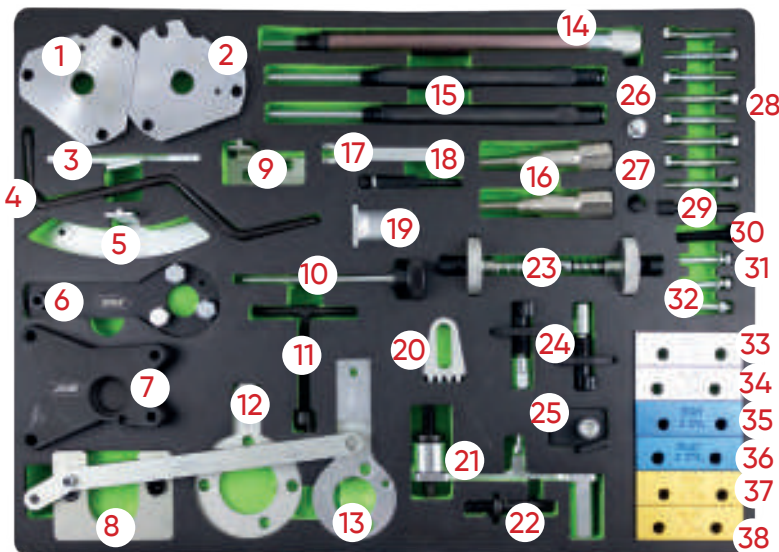

<b>MARCAS</b>	ALFA: Romeo 145, 146, 147, 155, 156, 159, 166, Spider, GTV, TS, GT, Crosswagon Q4 FIAT: Punto, Grande Punto, Brava, Bravo, Marea, Weekend, Stilo, Doblo, Cargo, Idea, Panda, Multipla, Palio, Stilo, 500 LANCIA: Lybra, Ypsilon, Thesis, Musa OPEL: Corsa, Agila, Meriva, Combo, Vectra, Zara, Astra, Insignia, Signum 1.9 CDTI SUZUKI: Ignis, Swift, Wagon R+ FORD: Ka
<b>FERRAMENTAS OEM</b>	1860874000 (1), 1860874000 (2), 2000004400 / 2190754400 (3), 1860863000 (4), 1860898000 (5), 2190754500 (6), 2000004300 (7), 1870900400 (8), 1860703000 (9), 1860933000 (10), 1860845000 (11), 1870900300 (12), 1860905000 / EN-46788 (13), 1895443000 (14), 1860992000 (15), 1870896900 (16), 1860987000 (17), 1860905000 (18), 1860771000 (19), 1860161000 (20), 1860876000 (21), 1860876000 (22), 1871000900 (23), 1860985000 (24), 2000004200 / 2190754200 (25), 1860965000 (29)

**CÓDIGOS DE MOTOR**

176B9.000, 182B2.000, 188A5.000, 843A1.000, 323.02, 371.01, 182B4.000, 182B9.000, 186A6.000, 188A2.000, 188A7.000, 188B2.000, 192A1.000, 192A3.000, 937A2.000, 939A1.000, 192A5.000, 192B1.000, 198A5.000, 937A5.000, 939A2.000, 325.01, 342.02, 362.02, 185A6.000, 841C.000, 841G.000, 939A3.000, 940A3.000, 940A4.000, 940A5.000, Z19DT/DTH/DTR/DTJ/DTL, 169A1.000, 955A4.000, 350A3.000, 192B4.000, 198A2.000, 350A2.000, 955A3.000, 192A8.000, 198A6.000, 198A3.000, 199B1.000, 199B2.000, 199A2.000, 199A3.000, 199A9.000, 188A3.000, 188A8.000, 188A9.000, 192A9.000, 186A8.000, 186A9.000, 199A5.000, 223A7.000, 223A9.000, 841H.000, 841P.000, 185A2.000, Z13DT, Z13DTJ, Z13DTH, 182A4.000, 182A6.000, 182B6.000, 178B3.000, 186A3.000, 186A4.000, 350A1.000, 169A4.000, 188A4.000, 199A4.000, 199A7.000

# KIT DE BLOQUEIO FORD / SEAT / VOLKSWAGEN / MAZDA / VOLVO

53770 198,00€

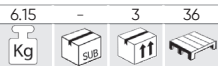

GASOLINA/PETROL

GASOIL/DIESEL

<b>MARCAS</b>	FORD: Fiesta, Fusion, Courier, Escort, Focus, Focus C Max, Puma, Mondeo, Sierra, Cougar, Galaxy, C-Max, Orion, Tourneo Connect, Transit, Transit Connect. VW: Sharan. SEAT: Alhambra. MAZDA: 121. VOLVO: S40, V50.
<b>FERRAMENTAS OEM</b>	303-1061 (1), 303-1054 (2), 23-059 / 310-085 (3), 21-105 (4), 323-029 (6), 0194-B / 21-263 / 303-735 / 49 JE 02 021 (7), 0132-AB / 0178-D / 21-151 (9), 0194-C, 21-262, 303-734, 49 JE 02 020 (10), 21-238 / 303-679A / 303-1151 (11), 21-238 / 303-679A / 303-1151 (12), 303-1054 (13), 303-1151 (14), 21-238 / 303-679A (15), 303-393 / 303-393-02 (16), 303-1097 (17), 21-168 / 303-393 (18), 303-0985 (20), 2064 / 23-047 / 310-055 / U20003 (21), 303-652 (22), 21-229, 303-651 (23), 303-748 (24), 21-210 (25), 21-260, 303-732 (26), 21-163, 303-620 (27), 21-234 / 21-251 (28), 303-675 / 303-698 (29), 21-104 / 303-193 (30) / 21-162B / 303-367 / 303-376 (31), 21-162B / 303-376 / 303-376B (32), 23-019 (33), 23-058 / 310-084 (34), 0153-M / 0178-C / 0178-D (35), 0178-B / 5711-TB (36), 21-123 (37), 23-020 (38), 21-234 / 21-251 (39), 303-1059 (40), 23-019 (41), 303-1060 (42), 303-393 / 303-393-01 (43)
<b>CÓDIGOS DE MOTOR</b>	FUJA, FUJB, FXJA, FXJB, FXJC, FYJA, FYJB, F8JA, F8JB, M7JA, M7JB, DHA, DHB, DHC, DHD, DHE, DHF, DHG, FHA, FHE, LIT, LIV, LIE, LIG, LIH, LIK, RDA, RDB, RKC, RQB, RQC, FXDA/C, FXDB/D, FYDA/C, FYDB/D, FYDH, HWDAIZ, AHU, AVG, AFN, D24, D24T, D24TIC, RFN, RTJ, RTK, RVA, RFK, RKD, B4164S3, DV4TD (8HV/8HX/8HZ), DV4TED4(8HV/8HY), DV6ATED4 (9HX/9HY/9HZ) F6JA, F6JB, F6JC, G8DA, G8DB, KKDA, SNJA, SNJB, STJA, STJB, ASDA, ASDB, FXJC, SPJA, SPJC, FYJC, HWDA, HWDB, SHDA, SHDB, SHDC, JQDA, LQDB, JTDA, JTDB, HXDA, HXJA, HXJB, IQDA/B, IQDB, PNBA, PNDA, RHBA, SIDA, F6JD, TZJA, TZJB, HHDA, HHDB, HHJA, HHJB, HHJC, HHJD, HHJE, HHJF, RTA, RTB, RTC, RTD, RTG, RTE, RTF, RTH, RTJ, RTK, RFN, BHPA, HCPA, HCPB, KKDA, P7PA, P9PA, P9PB, R2PA, R3PA, RWPA, RWPC, F9DA/B, FFBA, FFWA, KHBA, QYBA, QYWA, KKDB, C9DC, RVA, IZ, AFN, AHU, ANU, AUY, G6DA, G6DB, G6DC, G6DD, G6DE, G6DF, G6DG, UFDB, TXDB, TYDA, UKDB, QXBA, AZBA, KLBA, QXBB, LPBA, AZBC, TYBA, UKBA, UFBA, TXBA, IXDA, QXWA, QXWB, AZWA, KLWA, AZWC, TYWA, UKWA, TXWA, UFWA, UFDA, TXDA, UKDA, Q4BA, KNBA, 4BA, 4BB, 4BC, 4CC, 4FA, 4CA, 4CB, 4DA, 4EA, 4FA, 4FB, 4FC, 4FD, 4GA, 4HB, 4HC, 4EB, 4EC, 4ED 4GA, 4GB, 4GC, 4GD, 4GE, 4GF, 4HA, 4HD, FMBA/B, D5BA, ABFA, D3FA, D6BA, HJBA/B, F3FA, D2FA, D4FA, F4FA, F5FA, DOFA, QJBA, QJBB, QJBC, QJBD, FXFA, H9FA, H9FB, N7BA, N7BB, MZ-CD 1.6, V6

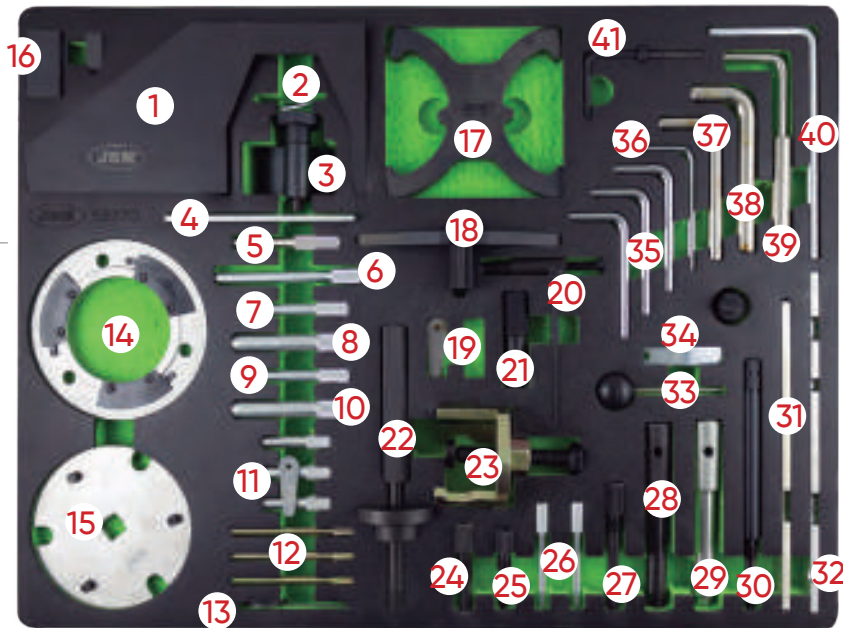

# KIT DE BLOQUEIO OPEL / CHEVROLET / SAAB / FIAT / LANCIA / SUZUKI / FORD

53774 190,00€



GASOLINA/PETROL

GASOIL/DIESEL

<b>MARCAS</b>	ALFA: 145, 146, 147, 156, 159, 166, GT, Crosswagon Q4 FIAT: Punto, Grande Punto, Bravo, Brava, Marea Weekend, Stilo, Doblo, Cargo, Multipla Idea, Panda LANCIA: Ypsilon, Musa, Lybra, Thesis OPEL: Corsa B/C, Combo, Tigra, Agila, Tigra B, Meriva, Astra F/G/H, Astravan, Speedster VX220, Zafira A/B, Vectra B/C, Signum, Omega B, Sintra, Frontera A/B, Astravan, Kadett, Ascona, Omega, Monterey, Antara, Croma, Speedster VX220 SUZUKI: Ignis, Swift, Wagon R+ FORD: Ka CHEVROLET & DAEWOO: Epica, Captiva, Nubira, Lacetti, Evanda SAAB: 9-3, 9-5 (98-04)
<b>FERRAMENTAS OEM</b>	1860905000 / 1860905010 / EN-46788 (1), KM-6148 (2), KM-6148 (3), 1870900400 / 1871000200 (4), KM-954 (5), KM-J-43651 (6), 1860905000 / 1860905010 / EN-46788 (7), KM-852 (8), KM-853 (9), 1870900300 / 303-1468 (10), EN-46785 / KM-951 (11), KM-932 (12), 1860703000 (13), KM-955 (14), KM-6130 / KM-6349 / KM-6349 (15), KM-927 (16), EN-48245 (17), KM-933 (18), EN-46785 (19), 1860985000 / 1871000900 / EN-46781 (20), 1860985000 / 1871000900 / EN-46781 (21), EN-48246 (22), KM-929 (23), 1870896900 / EN-46789 (24), KM-952 (25), 21-162B / 303-376 / 303-376B (26), KM-933 (27)
<b>CÓDIGOS DE MOTOR</b>	X14XE, Z14XE, X16SEJ, X16XE, X16XEL, Y16XE, Z16XE, Z16YNG, C18XEL, X18XE, X18XE1, Z18XE, Z18XEL, C20SEL, C20XE, X20XEV, Z20LEH, Z20LEL, Z20LER, Z20LET, X22SE, X22XE, Y22SE, Y22XE, Z22XE, D223L, X10XE, Z10XE, Z10XEP, X12XE, Z12XE, Z14XEP, X20DTL, X20DTH, X22DTH, Y20DTL, Y20DTH, Y22DTH, Y22DTR, 169A1.000, 955A4.000, 350A3.000, 192B4.000, 198A2.000, 350A2.000, 955A3.000, 192A8.000, 198A6.000, 198A3.000, 199B1.000, 199B2.000, 199A2.000, 199A3.000, 199A9.000, 940A3.000, 188A3.000, 939A2.000, 188B2.000, 188A8.000, 188A9.000, 323.02, 371.01, 937A2.000, 182B4.000, 182B9.000, 188A2.000, 188A7.000, 192A9.000, 186A6.000, 186A8.000, 192A1.000, 192A3.000, 192A5.000, 192B1.000, 186A9.000, 939A1.000, 199A5.000, 223A7.000, 223A9.000, 342.02, 362.02, 841G.000, 841H.000, 841P.000, 939A3.000, 185A2.000, 185A6.000, Z13DT, Z13DTJ, Z13DTH, Z19DT, Z19DTH, Z19DTJ, Z19DTL, X10XE, Z10XE, Z10XEP, Z12XE, Z14XEP, X16SZR, Z16SE, 4EC1/T, 4EC1, 4EE1/T, 4EE1, X17DT, Y17DT, Y17DTI, Y17DTL, 16DA, 17D, 17DR/X, 7DTL, X17DTL, 4JX1/4, JG2T, 4FC1/T, 4FD1, X20DTL, Y20DTL, D223L Z20DMH, Z20DM, RA420, Z20S1, 194A1.000, Z22SE, Z22YH

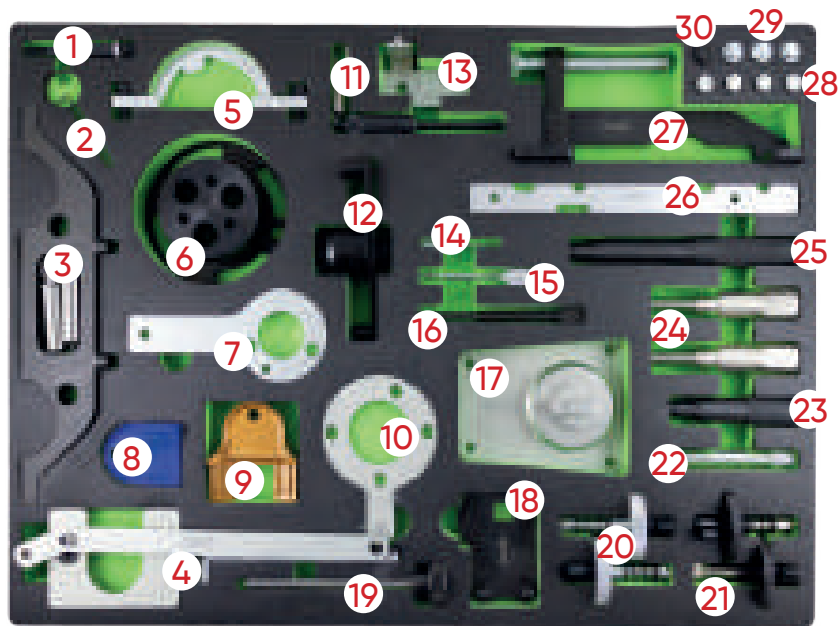



# KIT DE BLOQUEIO FIAT / FORD / CITROËN / PEUGEOT

53771 158,00€

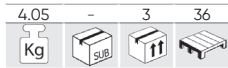

GASOLINA/PETROL

GASOIL/DIESEL

<b>MARCAS</b>	<p>FIAT: Ulysse, Scudo, Ducato                  LANCIA: Zeta, Phedra                  FORD: Fiesta, Fusion, Focus, Focus C-Max                  CITROËN: C15, C1, C2, C3 Pluriel, C4, C4 Picasso, C5, C6, C8, DS3, DS4, DS5, Xantia, Xsara, Xsara Picasso, Evasion, Berlingo, Jumpy, Jumper, Saxo, ZX, XM, Evasion, AX                  PEUGEOT: 107, 1007, 206 cc, 207, 208, 306, 307 cc, 308, 406, 407, 508, 607, 806, 807, Partner, Expert, Boxer, 206, 106, 605, 205, 405</p>
<b>FERRAMENTAS OEM</b>	<p>4200-TH (1), 0117-AR (2), 0188-X (3), 0606-A1A2 (4), 0188-Q2 (5), 0189-S1 (6), 7017-TR (7), 0132-P / 4507-TL (8), 0189-C (9), 0188-J1 (10), 0188-J2 (11), 0178-E (12), 0189-R (13), 0132-AK / 0188-AK / 0188-K / 0153-AK / 4533-TAD / MOT 1436 (14), 0188-AH (15), 0189-S2 (16), 0153-AB / 9041-TZ (17), 0153-M / 0178-C / 0178-D / 7014-TM / 9767-94 (18), 0189-A (19), 4527-TS1 (20), 0153-AB / 9041-TZ (21), 0189-B / 21-163 (22), 0132-AJ1 / 0153-G / 0188-M / 0189-J / 4533-TAC1 / 5711-TA (24), 0189-L (25), 0188-D / 7017-TM (26), 0132-X / 0188-Q1 / 4507-TJ / 9767-89 (27), 0194-B (28), 0132-AB / 0194-A (29), 0194-C / 21-262 / 303-734 (30), 4527-TS2 (31), 0188-E (32), 0153-A / 6012-T / 9765-54 (33), 0134-AF / 0134-Q / 0188-F / 9004-T (34), 0188-P2 / 0188-P / 174 / 7015-T (35), 0153-U 7019-T (36), 0153-N / 0188-Y / 7014-TJ / 7099-TM / 9797-34 (37)</p>

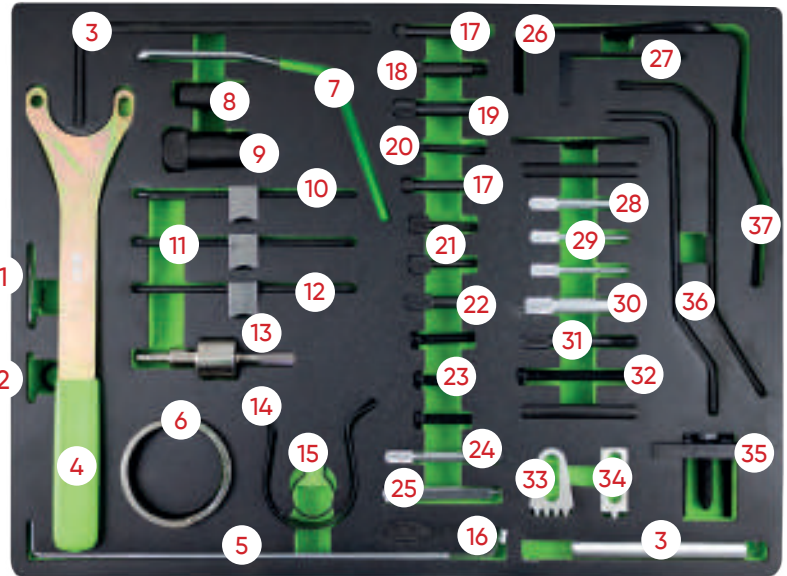

<b>CÓDIGOS DE MOTOR</b>	<p>F6JA, F6JB, F6JC, G8DA, G8DB, HHDA, HHDB, HHJA, HHJB                  Citroën_Peugeot: 1.0 / 1.1 / 1.4 / 1.6 / 1.6 16V, 1.4 / 1.6HDI / 1.8 / 1.8 16V / 2.0 / 2.0 Turbo, 1.9D / 2.0HDI / 2.2HDI / 1.8 16V / 2.0 16V                  TU9 (CDY/CDZ), TU1 (HDY/HDZ/HFX/HFY/HFZ), TU3 (KDX/KDY/KDZ/KFX/KFZ), TU5JP4 (NFU/NFX), TU5 (BDY/BFZ/NFT/NFV/NFW/NFY/NFZ), XU7 (LFW/LFX/LFZ), EW7J4 (RLZ), XU7JP4 (LGY), XU10 (RFL/RFU/RFV/RFX/RGX/RGY), XU10JP4(RGX/RGY), EW10A (RFJ), EW10J4S (RFK), EW10D (RLZ), EW12J4 (3FZ), ET3JE (KFU), TU3A/JP (KFW/KFX), DV4TD (8HW/8HX/8HZ), DV4TED4 (8HV/8HY), DV6ATED4 (9HX/9HY/9HZ), EW10-CV1 (RLZ), EW12 (3FZ), DW8 (WJZ/WJY), DW10 (RHY/RHV/RHZ/RHS/RHM/RHW/RHT/RHR/RHX), DW12 (4HX/4HZ/4HW/4HY), EW7J4 (6FZ), EW10J4 (RFR), EW10J4D (RLZ), DW12TED4 (4HW), DW10ATED (RHT/RHV/RHW/RHX/RHZ)                  Ford 1.4 / 1.6 Duratorq TDCI</p>
-------------------------	---

# KIT DE BLOQUEIO FORD / VAG / MAZDA / VOLVO

53772 229,00€

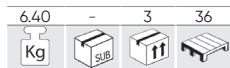

GASOLINA/PETROL

GASOIL/DIESEL

<b>MARCAS</b>	<p>ALDI: 80, A1, A2, A3, S3, A4, A5, A6, TT, Q5                  SEAT: Arosa, Ibiza, Cardoba, Leon, Toledo, Alhambra, Altea, Inca (99-04)                  SKODA: Fabia, Octavia, Superb                  VW: Lupo, Polo, Fox, Golf, Bora, Jetta, Golf Plus, Passat, Beetle, Touran, Sharan, Caddy, Caddy Maxi, Transporter, Golf VI Cabrio, Tiguan                  FORD: Galaxy</p>
<b>FERRAMENTAS OEM</b>	<p>T10252 (1), VAS6079 (2), T10121 (3), MP1-1312 / T10098 / T20038 / T20038 (4), T10123 (5), 23-058 / 310-084 / T10008 (6), 2065A / T10008 / U40021 (7), 3418 (8), T10171 (9), 23-059 / 23-059 / 310-085 / T10050 / T10050 (10), 3458 / T30094 (11), T10016 / T10074 / T10074 (12), T10100 (14), T10414 (15), 3366 / T20018 / T20044 (16), 3411 (17), 3369 / T30092 (18), T10341 (19), 3242 / T40069 / T30052 (20), T 40026 (21), 3359 / MP1-301 / T20102 (22), 2064 / U20003 (23), T10120 (24), MP1-1312 / T10098 / T20038 (25), T10170 (26), T00115 / T10264 / T40098 (27), T10092 (28), T00115 / T10264 / T40098 (29), 303-1054 / T10115 (30), T10060 / T10060A (31), 3359 / MP1-301 / T20102 (32), T10340 (33), 2587 (34), 3387 / U30009A (35), 3387 / T10020 (36)</p>

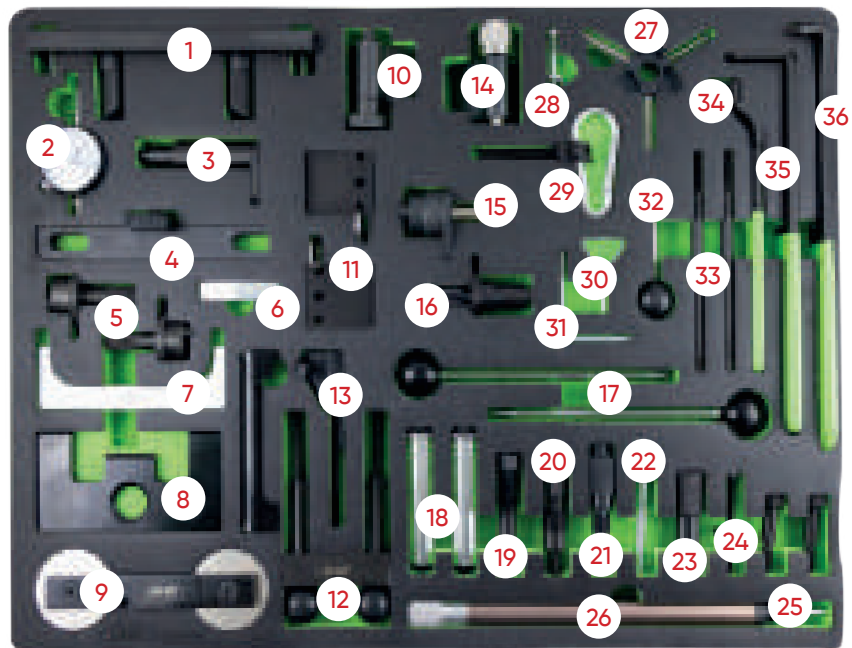

<b>CÓDIGOS DE MOTOR</b>	<p>ARC, ATN, AUS, AVY, AZD, AFH, BCA, AJV, AKQ, AUA, AUB, AXP, AFH, AFN, AFK, AHW, AHU, APE, AQQ, AUS, AXP, AZD, BBY, BBZ, BCB, ANY, AYZ, AMF, ATL, BAY, BHC, BMS, BNM, BNV, BWB, AJM, AMG, ANU, ARL, ASZ, ATD, ATJ, AUY, AVB, AVF, AVQ, AWX, AXB, AXC, AXR, BEW, BJB, BKC, BKE, BLS, BLT, BMT, BPX, BRB, BRM, BRR, BRB, BRU, BSU, BSW, BTB, BUK, BVK, BXF, BFX, AZV, BDJ, BDK, BGW, BHW, BKD, BKP, BLB, BMA, BMM, BMN, BMP, BMR, BNA, BPW, BRC, BRE, BRF, BRT, BUZ, BE, BVF, BVG, BVH, BVK, BTS, BMY, BLF, BVW, AZV, BKD, AWY, AZQ (55 - 64 PF), AXU, BAG, BKG, BLF, BLN, BLP, BFV, BKF, BNU, BVP, BVR, IZ, CBZA, CBZC, CBZB, CAXA, CAGA, CAGB, CAGC, CAHA, CAYA, CAYB, CAYC, CBAA, CBAB, CBAC, CBBA, CBBB, CBDA, CBDB, CBDC, CBEA, CEGA, CKUB, AZV, BDJ, BHP, BKD, BLB, BMA, BMM, BMN, BMP, BMR, BNA, BPW, BRC, BRE, BRF, BRT, BSS, BUY, BUZ, BVA, BVE, BVF, BVG, BVH, BWV, ACV, ACV, AFB, AGX, AHD, AHY, AHY, AJT, AKE, ANJ, APA, AUF, AXG, AXG, AXL, AYC, AYM, AYY, BAU, BBE, BBF, BCZ, BDG, BDH, BFC, BJJ, BJK, BJL, BJM</p>
-------------------------	---



## KIT DE BLOQUEIO VOLVO 3.0 / 3.2T6 FREELANDER2 3.2I

53315

285,00€

GASOLINA/PETROL

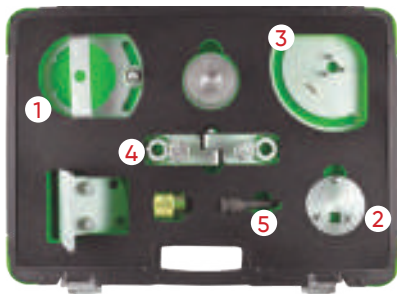
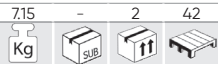

<b>MARCAS</b>	<u>VOLVO</u> : S60 (10-16), S80 (07-15), XC60 (08-15), XC70 (06-15), XC90 (10-14), V60 (10-15), V70 (10-15). <u>LAND ROVER</u> : Freelanders II (11-14).
<b>FERRAMENTAS OEM</b>	<u>VOLVO</u> : 999-7263 (3), 999-7264 (1), 999-7272 (5), 999-7257 (2), 999-7261 (4). <u>LAND ROVER</u> : 303-1225 (3), 303-1226 (1), 303-1219 (2), 303-1223 (4).
<b>CÓDIGOS DE MOTOR</b>	<u>3.0 Turbo</u> : B6304T2, B6304T4. <u>3.2</u> : B6324S, B6324S5. <u>3.2i6</u> : B6324S.

## JOGO DE EXTRAÇÃO PARA PINHÃO OU POLIA DE BOMBA DE ALTA PRESSÃO PARA HYUNDAI E KIA

54226

71,00€

GASOIL/DIESEL

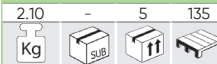

<b>MARCAS</b>	<u>HYUNDAI</u> : Accent (11-15), Elantra (07-10), i20 (09-18), ix20 (10-18), i20 Coupe (15-17), i30 (07-19), ix35 (10-16), i40 (11-18). <u>KIA</u> : Carens (13-18), Ceed (07-18), Optima (11-15), Pro-Ceed (08-19), Rio (09-17), Cerato (05-07), Soul (09-14), Sportage (10-18), Venga (09-18).
<b>FERRAMENTAS OEM</b>	09331-2A000/2A010 (1), 09331-2A010 (1)
<b>CÓDIGOS DE MOTOR</b>	1.1D CRDi: D3FF 1.4D CRDi: D4FC(U1), D4FC(U2) 1.6D CRDi: D4FB(U1), D4FB(U2), D4FB-H(U1), D4FB-H(U2), D4FB-L(U1) 1.7D CRDi: D4FD(U2), D4FD-H(U2), D4FD-L, D4FD-L(U2)

## KIT DE BLOQUEIO DE DISTRIBUIÇÃO PARA PORSCHE

54200

56,00€

GASOLINA/PETROL



<b>MARCAS</b>	911 (2001 - 2008), Boxster (2002 - 2011), Cayman (2006 - 2009)
<b>FERRAMENTAS OEM</b>	9685 (1), 9686 (2), 9595 (3), 9595/1 (4)
<b>CÓDIGOS DE MOTOR</b>	M96/03, M96/05, M96/23, M96/25, M97/20, M96/24, M96/26, M97/01, M97/21, M97/22.



## CONJUNTO DE 6 FERRAMENTAS DE SINCRONIZAÇÃO DE MOTOR

53775

1.109,00€

GASOLINA/PETROL

GASOIL/DIESEL



53769 RENAULT / NISSAN / OPEL / VOLVO



53770 FORD / SEAT / VOLKSWAGEN / MAZDA / VOLVO



53771 FIAT / FORD / CITROËN / PEUGEOT



53772 FORD / VAG / MAZDA / VOLVO



53773 FIAT / ALFA / LANCIA / OPEL / SUZUKI / FORD

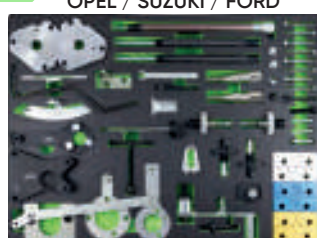

53774 OPEL / CHEVROLET / SAAB / FIAT / LANCIA / SUZUKI / FORD





# CARRO COM 7 GAVETAS COM KIT DE FERRAMENTAS DE AJUSTE DE SINCRONIZAÇÃO

**53951** 1.794,00€

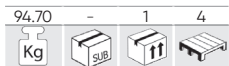

**53952** 1.794,00€

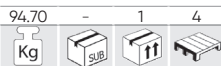

**53775** 1.109,00€

GASOLINA / PETROL

GASOIL / DIESEL

## CONJUNTO DE 6 MÓDULOS DE SINCRONIZAÇÃO DE MOTOR



## CHAVE UNIVERSAL PARA ÁRVORE DE CAMES + ADAPTADORES

**51340** 39,30€



- Contém:  
1 Chave: Faixa de abertura: 40 mm mín. - 235 mm máx. + Comprimento 540mm.  
4 jogos de 2 parafusos adaptadores de 4 medidas.  
1 juego de 2 roscas de 1cm de diámetro.



## EXTRATOR DE PINHÃO DE EIXO DO COMANDO FORD

**53318** 24,00€

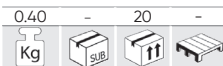

**MARCAS** FORD

**APLICÁVEL A MOTORES** F8M, F8Q, S8U, S9U.

## BLOQUEADOR DE CAMBOTA ÁRVORE DE CAMES RENAULT / NISSAN / DACIA / SUZUKI

**51488** 16,00€

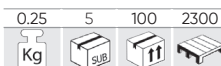

- Passadores de segurança para o conjunto de árvore de cames e a cambota para Renault, motores diesel e de gasolina.  
- Conveniente para o bloqueio do motor durante a substituição ou manutenção do conjunto da árvore de cames.

**MARCAS** **RENAULT:** Captur, Clio II,III,IV, Espace/Grand Espace III, IV, Fluence, Kadjar, Kangoo, Laguna I,II,III, Logan/ Logan MCV, Megane I,II,III,IV, Modus/Grand Modus, Scenic/Grand Scenic I,II,III,IV, Twing II, Trafic II, Master II 1.5dCi & 1.9 dCi.  
**DACIA:** Dokker, Duster, Lodgy, Logan, Sandero 1.5dCi  
**NISSAN:** Almera, Cube, Juke, Kubistar, Micra, Note, NV200/Evalia, Primera, Tiida, Interstar, Primastar 1.5dCi & 1.9 dCi  
**SUZUKI:** Grand Vitara, Jimny 1.5DDiS & 1.9DDiS

**FERRAMENTAS OEM** MOT1489, MOT1430, MOT1054.

**CÓDIGOS DE MOTOR** K9K, F8Q, F9Q - Gasolina, Clio, R19, Laguna 1.8/2.0 F3R F3P

## KIT DE BLOQUEIO DE DISTRIBUIÇÃO VAG

**52271** 18,00€



**MARCAS**

**AUDI:** A2 1.4TDI (02-06), A3 1.9 2.0TDI (02-08), A4 1.6TDI (02-05), A4 1.9 2.0TDI (04-08), A6 1.9TDI (02-05).  
**SEAT:** Altea 1.9SDI/TDI (05-08), Leon 1.9 2.0TDI (05-08), Toledo 1.9SDI/TDI (05-08).  
**SKODA:** Fabia 1.4TDI (03-06), Octavia II 2.0TDI (03-06)  
**VW:** Beetle 1.9TDI (02-08), Bora 1.9TDI (02-08), Fox 1.4TDI (02-08), Golf 1.9 2.0TDI (02-08), Lupo 1.4TDI (02-08), Polo 1.4, 1.9TDI (02-08), Sharan 1.9TDI (02-08).

**CÓDIGOS DE MOTOR**

**AUDI:** AMF, ASZ, ATD, AVB, AVF, AWX, AXR, AZV, BHC, BKC, BKD, BKE, BLB, BMN, BNA, BPW, BRB, BR, BRD, BRE, BRF, BUY, BVA, BVF, BVG.  
**SEAT:** BJB, BKC, BLS, BMM, BXE  
**SKODA:** AMF, AZV, BKD  
**VW:** AJM, AMF, ANU, ARL, ASZ, ATD, AUJ, AVB, AVF, AWX, AXR, BAY, BMS, BNM, BNV, BWB

## KIT DE BLOQUEIO DA ÁRVORE DE CAMES

**51489** 12,00€

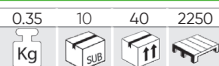

GASOLINA / PETROL

- Fácil de usar para o bloqueio das polias da árvore de cames quando se leva a cabo a manutenção.

**MARCAS**

**VW:** Lupo 99, Polo 95, Caddy 96, Polo Classic, Variant 96, Beetle 1.4L 99, Golf 1.4L, 1.6L 98 y 1.4L, Bora, 1.6L 99.  
**AUDI:** A2.

**FERRAMENTAS OEM** T10016.

**CÓDIGOS DE MOTOR** 1.4 / 1.6 16V



## FERRAMENTA DE BLOQUEIO DE ÁRVORE GRUPO VAG

**53320** 12,00€

GASOIL / DIESEL

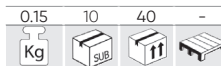

**MARCAS**

**SEAT:** Alhambra, Altea, Aro sa, Cordoba, Ibiza, Leon, Toledo 1.4/1.9/2.0 TDI.  
**VW:** Passat 1.9  
**AUDI:** A4/A6 1.9.

**FERRAMENTAS OEM** T10008, T20102, T10100.



## EXTRATOR/INSTALADOR DE CABBOTA CITROEN/PEUGEOT 1.0/1.2 VTI

53875 134,00€

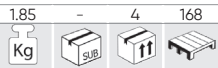

### MARCAS

VW: Golf, Touran  
AUDI: A3, A4

### FERRAMENTAS OEM

OEM T10134.

### CÓDIGOS DE MOTOR

1.4i turbo  
1.4 e 1.6 injeção direta de com-  
bustível  
1.9 / 2.0 SDI  
2.0 motores diesel Common Rail

## DESMONTADOR E TENSOR DE CORREIAS EN POLI-V

51927 25,00€

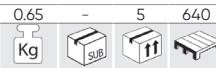

- Para montar-desmontar e extrair as novas correias em POLI-V facilmente.

- Adequado para o PSA e motores de Ford Fiesta 1.4/1.6, Citroën C4, Peugeot 307, Fiat Doblo, Dacia Logan.

- Ferramenta indispensável para uso profissional.

- Sem um ponto de agarre preciso, não é possível desmontar ou extrair as correias adequadas para este utensílio.



## TENSIÔMETRO PARA CORREIA DE TRANSMISSÃO

52616 44,00€

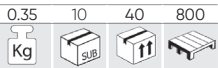

- Dois escalas ajustáveis (daN) com leitura dianteira e traseira.



## FERRAMENTA DE SINCRONIZAÇÃO DE POLIAS VW / AUDI 2.5 TDI 32MM

53325 7,50€

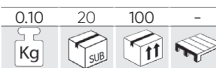

GASOLINA/PETROL



### MARCAS

AUDI: 100 ('91-), A6 (2.5 TDI) 2.3, 2.4, 2.5, 2.8, 2.9D TDI (1991-2003)  
VW: LT, Transporter

### CÓDI- GOS DE MOTOR

AAB, AAT, ACU, ACV, AEL, AET, AGX, AHG, AHY, AJA, AJT, ANJ, APA, APL, AUF, AVT, AXG, AXL, AYC.

FERRAMENTAS  
OEM 3355

## FERRAMENTA AJUSTE TENSÃO CORREIA VAG

53321 10,50€

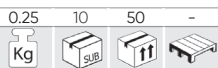

GASOLINA/PETROL

### MARCAS

AUDI: A4/1.8T, 2.0 1999-2004 A6/1.8T 2002-2004 A4/3.0 (2002 -), A6/3.0 (2002 -), A8/7.0 (2003 -).  
VW: Golf Passat 2.0 TDI DIESEL, Golf 88-97, Passat 92-97, VW T4/2.0 1992-2004.

### FERRAMENTAS OEM

T10020.



## FERRAMENTA RETENÇÃO BOMBA ANTICONGELANTE

53317 34,00€



GASOIL/DIESEL



- Usado para manter o motor na posição cronometrada durante a remoção / instalação da bomba de refrigeração.  
- Permite que a bomba seja substituída sem deslocar a corrente de distribuição

### MARCAS

OPEL 2.2 Corrente  
VAUXHALL 2.2 Corrente



## CHAVE 1/2 PARA CAMARA COMBUSTÃO

52819 22,00€

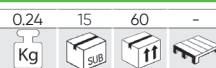

1/2" MERCEDES



58  
DENTES







## **ACESSÓRIOS LUBRIFICANTES**

- 248 TANQUES DE ARMAZENAMENTO DE BIDÕES
- 250 BOMBAS DISPENSADORA DE DIESEL
- 251 BOMBA DE UREIA AUS32
- 252 BOMBAS PARA TROCA DE ÓLEO
- 253 DRENADORES DE ÓLEO
- 256 PISTOLAS DE SUCÇÃO
- 258 DIVERSOS / FUNIS

## TANQUE DE ARMAZENAMENTO DE TAMBORES

Tampa removível / Paleta fixa para derramamento / Remover os tambores antes de usar uma empilhadeira / Fácil transporte / Para uso com a maioria das empilhadeiras e paletizadores / Feita de polietileno (PE) de 100% recicláveis.

SUPORTA 400 KG

**52804** 343,00€



**230L**



1 TAMBOR VERTICAL

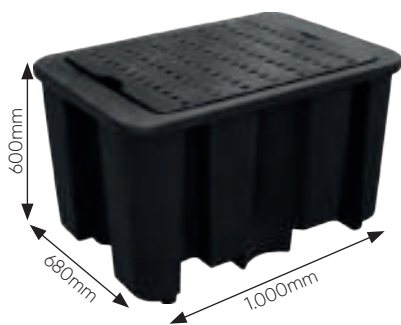

SUPORTA 650 KG

**52805** 426,00€



**250L**



2 TAMBORES VERTICAIS



NÃO ADEQUADO PARA PORTA PALETES. SUPORTA 1.250 KG

**52806** 742,00€



**250L**



4 TAMBORES VERTICAIS



## TANQUE DE ARMAZENAMENTO DE TAMBOR ESPECIAL EUROPALETE 2 BIDÕES

**53214** 285,00€

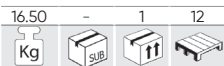

- Para 2 bidões.
- Compatível com a europalete (1200 mm x 800 mm) e paletes plásticas com dimensões similares.
- Empilhável para o transporte e o armazenamento económico.
- Colocar a europalete directamente acima da cubeta para reduzir o custo.
- As paletes carregadas podem ser postas em/retiradas da cubeta com o sem grelha por carreta elevatória.
- Cubeta com uma altura baixa ideal para o trabalho
- Capacidade em linha o por acima das normas Europeias, Britânicas e Americanas.
- Pode ser manipulado por carreta elevatória dos 4 lados ou transpalete por 2 lados coando esteja vazio.
- Fabricado em polietileno - 100% reciclável.

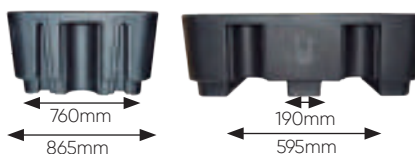

## CONTAINER IBC 1.000L

**52807** 1.714,00€

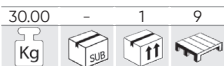

SUPORTA 2.500 KG

- Empilhável, economiza espaço, inovador.
- Altura baixa (700mm) Para uma utilização mais fácil.
- Ampla área de trabalho (2,5 m<sup>2</sup>).
- Plataforma com furos para as mãos e orifícios de inspeção.
- Fácil transporte.
- Compatível com a maioria das empilhadeiras e pallets.
- PE 100% reciclável e resistente aos raios UV.



APROVADO DIBT



# GALÃO DE METAL PARA COMBUSTÍVEL

<b>54181</b>	25,10€	1.45	-	4	72		<b>5L</b>	
		Kg	sub	ff				
55x26x35cm								
<b>54182</b>	34,70€	2.55	-	4	48		<b>10L</b>	
		Kg	sub	ff				
57x35x42.5cm								
<b>54184</b>	44,00€	4.10	-	4	24		<b>20L</b>	
		Kg	sub	ff				
76x37x50cm								

**54183** 38,20€

54x39x58cm

2.75 1 6 48

Kg sub ff

**10L**

**ANTI-CAPOTAMENTO**

**BOQUILHA FLEXÍVEL PARA BIDÃO METÁLICO**  
(REF.54181, 54182, 54183, 54184)

**15874**  
6,50€

0.30 50 800

Kg sub ff

## CARRO PORTA BIDÕES

**50924** 342,00€ - Apto para bidões de óleo de 200L.

31.00 - 1 6

Kg sub ff



**RODA GIRATÓRIA**

## BRAÇADEIRA PARA TAMBORES (CAPACIDADE DE 500 KG.)

**53612** 96,00€

4.75 - 1 66

Kg sub ff

**500Kg**

- Para lidar com bidão de óleo.
- Capacidade: 500kg
- Tipo de recolha vertical do bidão.
- Bidões de óleo especiais de 200L.



**CE**

## CHAVE PLÁSTICA PARA BIDÕES

**52452** 8,00€

0.12 6 60 1080

Kg sub ff





- Material: Nylon.
- Anti-chispa.
- Pontas em acabamento de 3/4" e 2".
- Útil para bidões de 200L.

## TORNEIRA PARA BIDÃO DE 200L

**53078** 18,00€

0.25 5 25 300

Kg sub ff



- Permite o esvaziamento rápido de tambores de 200 litros.
- Adequado para água, todos os tipos de óleos, álcool ou cetona, bem como ácidos fracamente concentrados e líquidos levemente alcalinos.
- Material: PE.
- Junta de EPDM.
- Mola em aço inoxidável.

## TORNEIRA DE PLÁSTICO DE 3/4" PARA BIDÃO DE ÓLEO 200L

**53518** 3,50€

0.05 10 500 3000

Kg sub ff



**UREA AUS32**

**200L**

- Adequado para todos os tipos de fluidos.
- 3/4" rosca externa.

## TORNEIRA DE 3/4" PARA BIDÃO DE ÓLEO DE 200L

**52453** 21,00€

0.19 5 100 1000

Kg sub ff



**UREA AUS32**

**200L**

- Torneira de segurança.
- Rosca de 3/4".
- Corpo de aleação.
- Junta de Nylon.
- Aplicações: Óleos, gasolina, diesel, queroseno.
- Válido para Urea AUS32.

## BOMBA DE COMBUSTÍVEL DIESEL COM DOSADOR E INDICADOR (200-240 V)

**53697** 398,00€

17,00	-	1	18
Kg	sub	ff	ff

- Tensão nominal: 200-240V.
- Potência nominal: 550W.
- Máx. vazão: 60 l/min.
- Comprimento do cabo: 2m.
- Comprimento da mangueira de sucção: 2m.
- Comprimento da mangueira de pressão: 4m.

COM PARADA AUTOMÁTICA



200V	550W	50Hz
240V		
2m	4m	60l/min



MANGUEIRA PARA FORNECIMENTO

15984	0,60	-
48,00€	Kg	ff

MANGUEIRA PARA REMOÇÃO

15983	0,60	10
11,50€	Kg	ff



BOMBA

15981	8,75	-	2
181,00€	Kg	sub	ff



COM PARADA DOSADORA

15980	1,20	20
55,00€	Kg	ff



INDICADOR DIESEL/ GASOLINA

15982	1,85	8
73,00€	Kg	ff

## BOMBAS DISPENSADORAS DE DIESEL COM PISTOLA

- Bomba de transferência de combustível portátil.
- Fácil de transportar: tamanho compacto com alça incorporada.

### BOMBA DISPENSADORA DE DIESEL COM PISTOLA (230 V)

**53610** 294,00€

13,00	-	1	24
Kg	sub	ff	ff

COM PARADA AUTOMÁTICA

- Elétrico.
- Fornecido com pistola e mangueiras.



230V	10A	2800 RPM	60l/min
550W			
2m	4m	Ativa a válvula de segurança	3m

BOMBA

15981	8,75	2
181,00€	Kg	ff

DOSADOR/L

15980	1,20	20
55,00€	Kg	ff

MANGUEIRA PARA REMOÇÃO

15983	0,60	10
11,50€	Kg	ff

MANGUEIRA PARA FORNECIMENTO

15984	0,60	-
48,00€	Kg	ff

### BOMBA DISPENSADORA DE DIESEL COM PISTOLA (12 V)

**53609** 190,00€

7,30	-	1	24
Kg	sub	ff	ff

COM PARADA AUTOMÁTICA

- Comprimento da mangueira de entrada: 2m.
- Comprimento da mangueira de saída: 4m.



12V	10A	3600 RPM	45l/min
175W			
2m	4m	Ativa a válvula de segurança	3m

BOMBA

15553	3,35	1
108,00€	Kg	ff

DOSADOR/L

15980	1,20	20
55,00€	Kg	ff

MANGUEIRA PARA REMOÇÃO

15983	0,60	10
11,50€	Kg	ff

MANGUEIRA PARA FORNECIMENTO

15984	0,60	-
48,00€	Kg	ff



## BOMBA DIESEL ELÉTRICA

**54100** 265,00€

4,00 Kg 4 SUB 4 24

12V 100V 240V 50-60Hz 18,4 L/min 200L 2m 2 bar 30 PSI

Comprimento do tubo de sucção: 850-1245mm  
 Comprimento da mangueira: 2m  
 Temperatura de trabalho: 5° - 40°C (41° a 104°F)  
 Tensão CC: 12V  
 Corrente alternada: 100-240V  
 Comprimento do cabo: 4m

## PISTOLA AUTOMÁTICA PARA UREA AUS 32

**15631** 98,00€

1,15 Kg 10 SUB

6 bar

## TANQUE DE UREA AUS32 (75 L)

**53644** 1.238,00€

18,15 Kg 1 SUB 1 4

75L UREA AUS32

- Uma construção autónoma e totalmente móvel de 75 L com uma bomba de 12V (permite atingir o desempenho no nível de 10 L/min com a pressão operacional de 40PSI), man-gueira e válvula de fechamento automático.
- O tanque de polietileno que é resistente ao impacto, corrosão e UV.
- As rodas de grande diâmetro (200mm) permitem que sejam manobradas facilmente no terreno desigual.

1.040mm 440mm 520mm

12V 40 PSI 2.75 bar 10 L/min 4m

## BOMBA ELÉTRICA PARA UREA AUS32

**53645** 268,00€

3,10 Kg 4 SUB 4 24

- Bomba de tambor elétrica projetada para meios à base de água, Urea AUS32 DEF e produtos químicos selecionados de tambores de metal de IBC de 205 L ou 1000-1250 L.
- Construção compacta e leve.
- Fusível incorporado para proteção contra sobrecarga e motor silencioso.
- Filtro de aço inoxidável embutido no tubo de sucção evitando que os contaminantes en-trem e causem danos.

INTERRUPTOR ON/OFF CONVENIENTE COM INDICADOR LED

O TUBO DE SUCÇÃO TELESCÓPICO ESTENDE-SE DE 850MM A 1245MM

O ADAPTADOR EMBUTIDO DE 2" + CONVERSOR DE ROSCA ADICIONAL PARA ADAPTADORES DE 2"

PISTOLA 15123 32,00€ 10 SUB

MANGUEIRA 4M 14473 46,00€ 5 SUB

ADAPTADOR DE ENTRADA PARA O TANQUE IBC 14703 13,00€ 50 SUB

30mm 187mm 187mm 2" BSP

12V 100V 240V 50-60Hz 18,4 L/min 200L 2m 2 bar 30 PSI

IVA não incluído

## BOMBA PARA TAMBOR DE ÓLEO + MANGUEIRA COM TORNEIRA

**52601** 397,00€

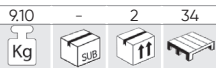

**200L**

- Pressão bombagem: 5:1.
- Entrada Ar: 1/4".
- Saída Ar: 1/4".
- Pressão trabalho: 6-8 bar.
- Pressão Máx.: 8 bar.
- Consumo de Ar: 250 L/min.
- Capacidade relativa 6 bar: 18 L/min.
- Temperatura do óleo: -10~50°C.
- Viscosidade máxima: 240 SAE.
- Compr. do tubo: 950 mm.
- Compr. do tubo: 950mm.

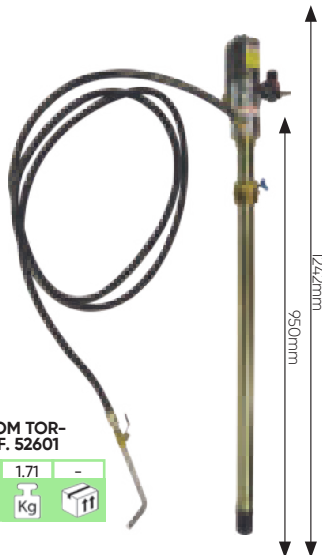

MANGUEIRA COM TORNEIRA PARA REF. 52601

**12056** 57,00€



## KIT BOMBA ÓLEO + MANGUEIRA + PISTOLA ÓLEO DIGITAL

**50935** 595,00€

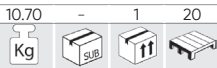

**200L**

- Viscosidade máxima: 240 SAE.
- Compr. da mangueira: 2 m.
- Compr. do Tubo: 950 mm.
- Capacidade relativa 6 bar: 18 L/min.
- Alcance de Temperatura do óleo: -10~50°C.
- Consumo de ar: 250 L/min.
- Pressão Bombagem: 5: 1.
- Entrada de Ar: 1/4".
- Saída de Ar: 1/2".
- Pressão trabalho: 6-8 bar.
- Pressão Máx.: 8 bar.

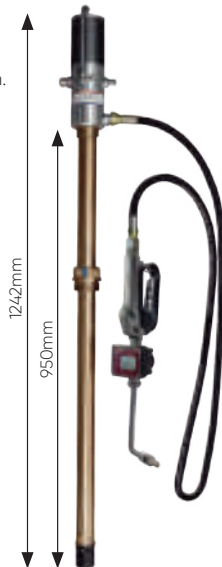

## BOMBA PARA BIDÃO DE ÓLEO

**50918** 341,00€

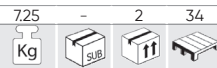

**200L**

- Pressão Bombagem: 5: 1.
- Entrada Ar : 1/4".
- Saída Ar: 1/2".
- Pressão trabalho : 6 - 8 bar.
- Pressão Máx. : 8 bar.
- Consumo de Ar : 250 L/min.
- Capacidade relativa 6 bar : 18 L/min.
- Temperatura do óleo: -10~50°C.
- Viscosidade máxima: 240 SAE.
- Compr. do tubo: 950mm.

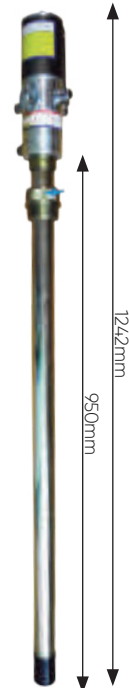

PORCA DE BIDADÃO PARA REF. 50935 E 50918



**10767** 21,00€



**10925** 18,00€



## PISTOLA DE BOMBEAMENTO DE ÓLEO COM CAUDALÍMETRO DIGITAL

**50917** 271,00€

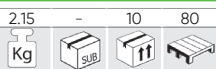

PILHA DE RECAMBIO P/50917

**10000** 7,00€



- Entrada de Ar: 1/2".
- Alcance de Caudal: 1-35 L/min.
- Pressão trabalho : 6 - 8 bar.
- Alcance de Temperatura do óleo : -10~60°C.
- Viscosidade máxima: 240 SAE.
- Pilha incluída.
- Peso: 1,4Kg.

## ADAPTADOR DE ROSCA DE TAMBORES PLÁSTICOS

**13982** 4,00€



- Permite o ajuste e compensação de várias roscas de tanques, tambores e bombas.



## BOMBA MANUAL PARA EXTRAÇÃO

**52428** 43,00€



- Para bidões entre 50 e 200L.
- Caudal 400ml por impulso.
- Capacidade de caudal: 32 L x minut.
- Adaptador de boca de 2" incluído.
- Tubos de sucção de 101cm com entrada de 1 1/4" e saída de 1".
- Não permitida a: Ácidos fortes, lixívia, gasolina.
- Aplicações: óleos, lubrificantes, diesel, fluidos à base de óleo.
- Recomendado para: diluente de laca, líquido de travões, detergentes, glicerina, ácidos suaves fluidos à base de petróleo.

## BOMBA DE ÓLEO MANUAL

**51253** 41,00€

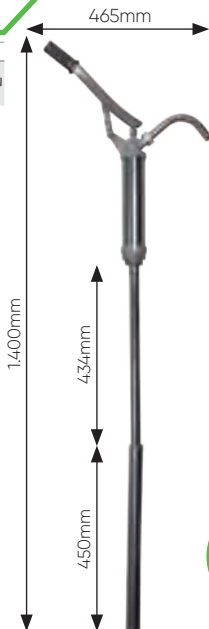
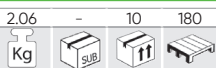

## BOMBA MANUAL PLÁSTICA DE EXTRAÇÃO

**52329** 36,40€



- Para bidões de 25, 50, 200L.
- 350ml por caudal.
- Corpo e pistão de polipropileno.
- Cabo de plástico ABS.
- Aplicações: alcoóis, óleos, gasolina, diesel, queroseno, etc.
- Conducto de sucção: Comp. mínimo: 320mm. Comp. máximo: 900mm.





# COLETOR DE ÓLEO COM SISTEMA DE ASPIRAÇÃO

53874 398,00€

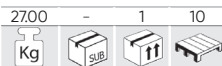

90L 8-10 BAR

DESMANCHA DISPONÍVEL

14937



15282



15283



15305



15306



15307



15310



15311



15312



15318



15308



Projetado para coletar e drenar o óleo do motor e da transmissão dos veículos.

- Pressão do ar de trabalho 8 ~ 10 bar
- Nível de vácuo: negativo 0 ~ 0,8 bar
- Volume do tanque: 70 l
- Volume do filtro de coleta 10 l
- Volume do copo de medição: 10 l
- Velocidade de sucção do óleo de acordo com o diâmetro da sonda: 0,8 l/min (Ø5x3,5 mm); 1 l/min (Ø6x4,5 mm); 1,6 l/min (Ø8x6,5 mm)
- Dimensões: 43x49x163 cm Meio: óleo do motor e óleo da transmissão
- Temperatura de óleo operacional recomendada: 40 ~ 60°C
- Com aspiração a vácuo.
- Sistema de medição pictórico.
- Grande tanque.
- Botão para controlar o uso.
- Rolos para fácil transporte.



WKŁAD WÓZKA KORKÓW OLEJU, 22 SZT.

15018 46,00€

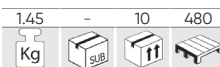

# COLETOR DE ÓLEO COM TANQUE

53873 285,00€



80L 1-3 BAR

Projetado para coletar e drenar o óleo do motor e da transmissão dos veículos.

- Pressão do ar de trabalho 1-3 bar
- Volume do tanque: 70 l
- Volume do filtro de coleta 10 l
- Dimensões: 35x48x163 cm
- Meio: óleo do motor e óleo da transmissão
- Grande tanque.
- Botão para controlar o uso.
- Rolos para fácil transporte.
- Pode ser usado para óleos de alta temperatura (sem limitação).

DESMANCHA DISPONÍVEL

15309

15308



14937



15305



15307



15312



REF.	CARACTERÍSTICAS	Kg	Box	Units	€
15018	Módulo de chaves para bujão de carter, 22pcs	1,45	-	10 480	46,00€
14937	Roda para colector de óleo 80l	0,30	-	14 -	9,50€
15305	Mangueira com válvula curvada	0,65	-	40 -	19,50€
15307	Funil	2,10	-	10 40	39,60€
15309	Tubo de conexão	0,75	-	20 -	17,00€
15312	Encaixe para conexão de tanque e mangueira	0,10	5	40 -	11,50€
15308	Pequena roda auto-orientante	0,35	-	40 -	7,00€

## BOMBA DE ASPIRAÇÃO DE ÓLEO - 12V

**53566** 32,00€

1,00	5	10	210
Kg	Sub	ff	

- O extrator de óleo é um dispositivo ideal para trocas de óleo rápidas e limpas.
- Funciona ligando os grampos à bateria do carro de 12V.
- O óleo é simplesmente retirado do motor através do orifício do medidor de óleo.
- Use o extrator apenas para óleo de motor, óleo diesel ou óleo de aquecimento.



<b>12V</b>	<b>70 dB(A)</b>	<b>5A</b>
<b>2.5(m/s)</b>	<b>MOTOR-OIL 1L/min</b>	<b>DIESEL-OIL 2L/min</b>

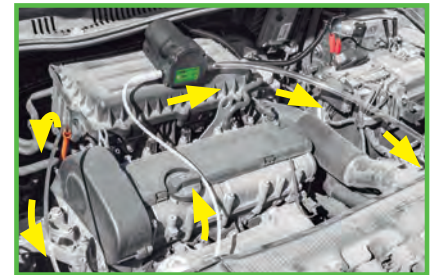

## KIT DE EXTRAÇÃO DE ÓLEO E COMBUSTÍVEL

**53627** 22,50€

0,55	-	12	96
Kg	Sub	ff	

- O dispositivo é projetado e fabricado para a remoção rápida de óleo, combustível e óleo de transmissão/diferencial de tanques de geradores, lavadoras de alta pressão, compressores pneumáticos, tratores de jardim ou veículos todo-o-terreno.



## COMPROVADOR DE ANTICONGELANTE

**53453** 7,00€

0,10	24	96	384
Kg	Sub	ff	

-43°C ~ 131°C



## TAPETE PARA DESINFECÇÃO DE CALÇADO

**53862** 6,00€

1,45	-	5	100
Kg	Sub	ff	

- Medidas: 85x55x10cm
- Material: TPE
- Capacidade máxima recomendada: 3L
- Capacidade máxima: 8L

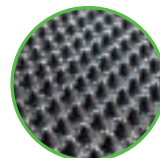

## TAPETE DE SECAGEM

**53863** 3,00€

0,70	-	5	240
Kg	Sub	ff	

- Medidas: 76x48cm
- Material: Poliéster

## REFRATÔMETRO PARA ÁLCOOL

**50731** 68,00€

0,56	-	5	500
Kg	Sub	ff	



## REFRATÔMETRO UNIVERSAL

**52963** 49,00€

0,28	5	20	460
Kg	Sub	ff	

**UREA AUS32**

- Etileno glicol: -50°C ~ -0°C.
- Propileno glicol: -50°C ~ -0°C.
- Fluido de limpeza: -40°C ~ -0°C.
- UREA AUS32: -30% ~ 35%.
- Fluido de bateria: -1.100 - 1.400 sg/l.





# MÁQUINA DE TROCA DE ÓLEO DE TRANSMISSÃO AUTOMÁTICA

**54050** 980,00€

Permite que você troque o óleo da transmissão no modo automático.



- Fonte de alimentação: 12 V (bateria de carro)
- Potência da bomba: 70W
- Diâmetro do medidor de pressão de óleo: 70 mm (ambos os medidores de pressão de óleo)
- Faixa de medição do medidor de óleo: 0-10 bar (0-150 psi)
- Volume do tanque de óleo fresco: 30 l
- Capacidade do tanque de óleo residual: 30 l

Completo:

- 1 dispositivo para troca e lavagem
- 1 conjunto de adaptadores com 37 adaptadores de conexão/adaptadores de mangueira
- 1 mangueira de conexão vermelha com engate rápido, comprimento de 250 mm, diâmetro de 12,5 mm (1/2 pol.), máx. 20 bar (300 psi)
- 1 mangueira de conexão preta com engate rápido, comprimento de 250 mm, diâmetro de 12,5 mm (1/2 pol.), máx. 20 bar (300 psi)



O conjunto de entrega inclui uma caixa com adaptadores para diferentes marcas de automóveis (Volkswagen, BMW, Land Rover, Ford, Mercedes, Buick).



PINÇAS DE BATERIA DE 12V

SET DE ADAPTADORES PARA REF. 54050

**15539** 1.30 5  
104,00€ Kg SUB

ELEMENTO DE FILTRO

**15542** 0.10 20  
45,00€ Kg

JUNTA TORICA PARA ENTRADA DE ÓLEO

**15480** 0.00 -  
0,99€ Kg

# BOMBA MANUAL PARA SISTEMAS DE TRANSMISSÕES COM ADAPTADORES

**52797** 198,00€

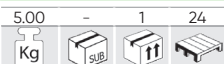

- Capacidade: 7,5L.
- Descarga: 80cc ciclo.
- Alcance de viscosidade até SAE 140.
- Suporta enchimento e esvaziamento

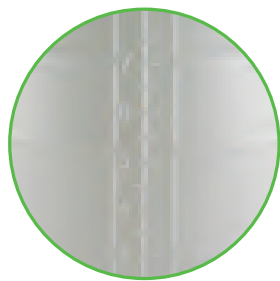

BOMBA DE ENCHIMENTO SISTEMA TRANSMISSÃO SEM ACESSÓRIOS REF. 52797

**13234** 3.75 1 24  
224,50€ Kg SUB



# SET DE ADAPTADORES PARA O SISTEMA DE BOMBA DE TRANSMISSÃO

**12044** 147,00€



**101**  
FORD 1/8 - 27 (NPT)

**102**  
UNIVERSAL, BMW, HONDA, NISSAN, etc

**103**  
VW/AUDI, SKODA

**104**  
VW/AUDI, PORSCHE

**105**  
VW/AUDI, MINI COOPER M10x1.0

**106**  
VW/AUDI DSG M24x1.5

**107**  
VW/AUDI CVT M22x1.5

**108**  
MERCEDES M12x1.5

**109**  
VW/SKODA M18x1.5

**110**  
AUDI/VW, SKODA, M30x1.5

**111**  
UNIVERSAL FLEXÍVEL 300mm, HONDA, HYUNDAI, KIA, etc.

**112**  
VOLVO 5/16 - 24 (UNF)

**113**  
TOYOTA, LEXUS M18x1.0

**114**  
NISSAN, INFINITY M8x1.0

**115**  
ATF - ADAPTER VW PASSAT



15 PCS

## BOMBA INJETORA DIESEL

**52801** 26,00€

0.10	5	50	600
Kg	sub	ff	sub

- Durante a substituição da bomba de injeção, filtros ou outras partes, impede e retracção do combustível para o depósito.
- Após a montagem de peças para substituir bomba permite bombear combustível para linha de injeção.



## BOMBA MANUAL EXTRAÇÃO GASOIL

**52789** 15,20€

0.15	10	24	192
Kg	sub	ff	sub

- Mangueira 90cm longo em cada extremidade.



## CARRETEL DE MANGUEIRA PARA ÓLEO BOCA DE 1/2"

**50797** 490,00€

26.60	-	1	14
Kg	sub	ff	sub

- À base de óleo / bobina
- Comprimento da mangueira: 15 + 1 m
- Máx. pressão de trabalho: 2.450 psi
- Entrada de ar: 1/2" BSPT (rosca cônica padrão britânico)
- Saída de ar: 1/2", rosca cônica padrão britânico
- Material: aço



15m **160 BAR**



## SERINGA TRANSPARENTE

**52498** 58,00€

0.85	-	10	120
Kg	sub	ff	sub

- Fabricada em polipropileno.
- Corpo transparente.
- Apta para usar em óleos de transmissão e diferenciais.
- Resistente a líquido de travões e anticongelantes.

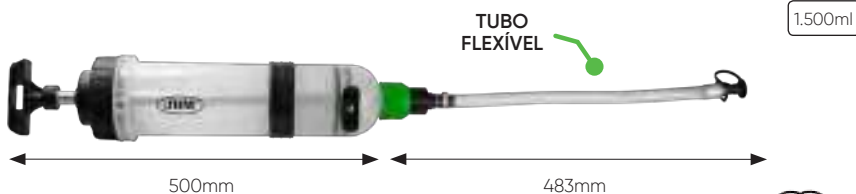

TUBO FLEXÍVEL

1.500ml



DOS O-RINGS PARA REF. 52498

**11867** 0.02 100  
9,00€ Kg ff



**52628** 26,50€

0.25	5	20	360
Kg	sub	ff	sub

- Para fluido de freio.
- Conector rápido na ponta.

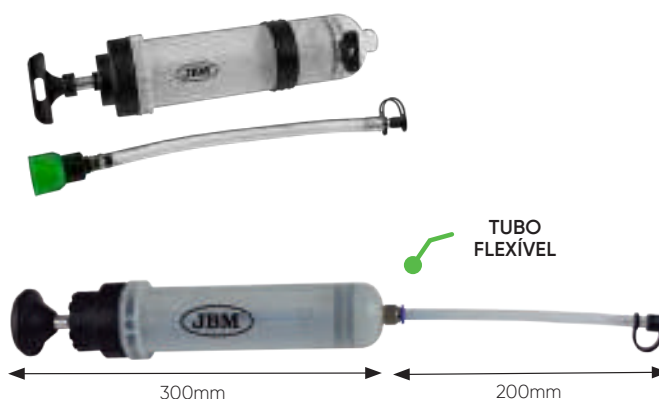

TUBO FLEXÍVEL

200ml



## SERINGA DE SUCCÃO DE ÓLEO

**51928** 14,00€

0.82	5	20	420
Kg	sub	ff	sub



CRO-MADO 500ml

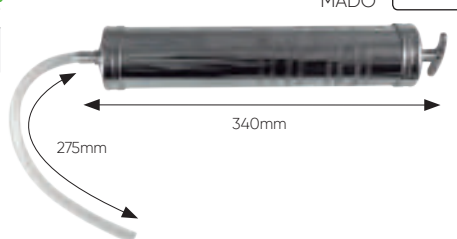

275mm

340mm



## PISTOLA DE LUBRIFICAÇÃO COMPACTA

**53849** 16,10€

0.30	-	40	880
Kg	sub	ff	sub

- Esta pistola engrasadora é perfeita para barcos, motos, bicicletas elétricas, bicicletas ou outro tipo de máquina ou equipamento que precise lubrificação.
- Muito confortável para trabalhar só com uma mão.

- Boca 0.5mm.
- Tampa removível com tubo 50°.
- Pressão de trabalho 1000 psi.
- Bomba de carga: impulso por mola.



80cc



## PISTOLA GRAZEIRA MANUAL COM TUBO FLEXÍVEL

50852 24,50€

500ml

1.30	5	20	240
Kg	sub	ff	sub



## BOMBA DE MASSA PNEUMÁTICA

50751 43,00€

1.50	5	10	150
Kg	sub	ff	sub

- Tubo rígido
- Tubo flexível
- Pressão: 30Mpa



## ACOPLADOR DE LUBRIFICAÇÃO DE LIBERAÇÃO RÁPIDA

53592 25,00€

Recomenda-se usá-lo com as pistolas graxeras JBM ref. 50751 e 50852, embora seja adequada para uso na maioria das pistolas.

0.15	25	100	-
Kg	sub	ff	sub

- Design ergonómico.
- Fácil de manusear: faz que acoplar e o desacoplar seja realizado sem esforço e economizando tempo de trabalho.
- A válvula de retenção integrada permite que a unidade seja facilmente desconectada a pressões de até 15.000 PSI (1.034 bar).
- Conexão integrada de 1/8 NPT.



## CONJUNTO COMPLETO DE ACESSÓRIOS PISTOLA DE LUBRIFICAÇÃO

54255 68,00€

1.60	-	10	500
Kg	sub	ff	sub

300mm

7 PCS 360°

330mm 90°

- x1
- x1
- x1
- x1
- x1
- x1



## RECOLHEDORES PVC

Saída lateral para esvaziar / Com asa de agarrar / PVC muito resistente.

### DE ANTICONGELANTE

53215 19,00€

0.95	-	6	60
Kg	sub	ff	sub

18L

- Medidas: Comprimento: 185cm / Diâmetro: 380mm.



### DE ÓLEO

53144 18,00€

0.99	-	6	48
Kg	sub	ff	sub

18L

- Medidas: Comprimento: 185cm / Diâmetro: 380mm.



## BANDEJA DE TROCA DE ÓLEO 8L

54051 39,00€

1.95	-	4	32
Kg	sub	ff	sub

110mm 600mm 330mm

8L

PE

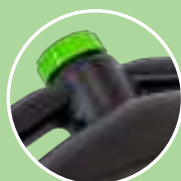

## BANDEJA DE AÇO PARA LÍQUIDOS

**51356** 48,00€

3,00 - 5 30  
Kg SUB ff

23 L

110mm 400mm 600mm



## GALHETAS DE ÓLEO 250ml

**52243** 8,50€

0,14 5 60 720  
Kg SUB ff

250ml

130mm

125mm

## JARRO COM PESCOÇO FLEXÍVEL

**52991** 10,50€

0,16 - 20 240  
Kg SUB ff

2L

**52992** 18,00€

0,30 - 8 96  
Kg SUB ff

5L

## GALHETAS DE ÓLEO 500ml

**52242** 12,00€

0,28 10 60 480  
Kg SUB ff

160mm

120mm

## FUNIL PARA BIDÃO DE 200L COM TAMPA E FILTRO

**53187** 39,00€

0,75 - 18 54  
Kg SUB ff

4,5L

- Ø Interior: 245mm.  
- Ø Exterior: 255mm.

FILTRO

## JOGO DE 3 FUNILS

**53188** 7,00€

0,15 - 24 288  
Kg SUB ff

Ø 90mm  
130mm  
180mm

## FUNIL COM FILTRO

**52391** 5,00€

0,09 5 20 240  
Kg SUB ff

950ml

140 x 15mm

## FUNIL COM TUBO FLEXÍVEL

**53198** 9,50€

0,15 - 24 144  
Kg SUB ff

Ø 180mm

1,89L

530mm





## **FERRAMENTAS HIDRÁULICAS**

- 260 MACACOS HIDRÁULICOS
- 262 MACACO DE GARRAFA
- 263 PREGUIÇAS
- 265 TRANSPORTADOR DE RODAS/PNEU
- 266 PRENSAS
- 267 GRUAS
- 268 SUPORTES PARA MOTORES
- 269 PARA MOTAS
- 270 TRASPALET

## MACACO HIDRÁULICO DE RODAS - SISTEMA RÁPIDO

**53725** 248,00€

32,00 - 1 18



↑465mm  
↓133mm

**3T**



CUMPRE COM: EN 1494:2001

344mm 682mm 155mm

CAÇOLETA COM PROTEÇÃO DE BORRACHA



RODAS DE NYLON



PISTÃO HIDRÁULICO

**14709** 6,15 5  
122,00€ Kg

## MACACO HIDRÁULICO 3TON COM ALAVANCA DE ELEVAÇÃO

**53422** 368,00€

44,50 - 1 15



↑533mm  
↓100mm

**3T**



CE

372mm 778mm 165mm

CAÇOLETA COM PROTEÇÃO DE BORRACHA

ESPUMA

ALAVANCA DE ELEVAÇÃO



RODAS DE NYLON

RODA GIRATÓRIA PARA REF. 53422

**14071** 25  
21,50€

RODA FIXA PARA REF. 53422

**14072** 25  
21,50€

PISTÃO PARA REF. 53422

**14073** 3  
128,00€

## MACACO HIDRÁULICO COM PEDAL

**53112** 298,00€

39,95 - 1 18



↑520mm  
↓140mm

**3T**



CE

345mm 720mm 185mm



RÁPIDA ASCENSÃO



PISTÃO HIDRÁULICO PARA MACACO REF. 53112

**13853**  
122,00€

COBERTURA DE BORRACHA PARA MACACO NO CARRINHO, REF. 53112

**13836**  
9,00€

## MACACO HIDRÁULICO DE RODAS 2T ESPECIAL CARROS BAIXOS

**53421** 298,00€

33,50 - 1 18



↑505mm  
↓75mm

**2T**

PISTÃO DUPLO



CE

360mm 740mm 150mm

CAÇOLETA COM PROTEÇÃO DE BORRACHA

ESPUMA



RODAS DE NYLON

RODA GIRATÓRIA PARA REF. 53421

**14068** 50  
13,00€

PISTÃO PARA REF. 53421

**14070** 4  
116,00€

RODA FIXA PARA REF. 53421

**14069** 50  
13,00€

## MACACO HIDRÁULICO DE RODAS 2,5T ESPECIAL CARROS BAIXOS

**54137** 288,00€

30,65 - 1 18



↑505mm  
↓78mm

**2,5T**

740mm 350mm 150mm





## MACACO HIDRÁULICO DE RODAS

**50818** 198,00€

346mm 685mm 180mm

35,80 - 1 18  
Kg SUB if

495mm  
133mm  
**3,5T**



**CE**  
EN 1494:2001



**ELEMENTO DE BORRACHA PARA PLACA PARA REF. 50818**

**14615** 0,05 100  
9,50€ Kg if

**PISTÃO SUBSTITUIÇÃO PARA REF. 50818**

**10768** 6,35 4  
113,00€ Kg if

**TORNILHO DE SUJEÇÃO LATERAL PARA REF. 50818**

**10639** 0,34 5  
10,90€ Kg if

**CAZOLETA DE APOYO PARA REF. 50818**

**10769** 0,30 1  
21,00€ Kg if

**MUELLE CRICK PARA REF. 50818**

**10770** 0,05 50  
6,00€ Kg if

## MACACO HIDRÁULICO DE RODAS 2T ESPECIAL CARROS BAIXOS

**50816** 88,00€

208mm 508mm 125mm

11,25 - 1 63  
Kg SUB if

340mm  
90mm  
**2T**



**CE**

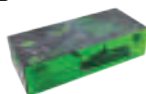

**PISTÃO HIDRÁULICO PARA REF. 50816**

**14708** 10  
59,00€ if

## MACACO HIDRÁULICO COM RODAS 2T

**53968** 49,00€

205mm 490mm 140mm

5,80 - 1 90  
Kg SUB if

300mm  
130mm  
**2T**



**CE** EN 1494:2001



## MACACO HIDRÁULICO DE RODAS 2T

**50815** 88,00€

205mm 490mm 140mm

10,75 - 1 56  
Kg SUB if

355mm  
130mm  
**2T**



**CE**



**PISTÃO HIDRÁULICO PARA REF. 50815**

**11939** 6,00 5  
63,00€ Kg if

## EM CAIXA PLÁSTICA

**51895** 99,00€

205mm 490mm 140mm

11,68 - 1 42  
Kg SUB if

355mm  
130mm  
**2T**



**CE**



**PISTÃO HIDRÁULICO PARA REF. 51895**

**11939** 6,00 5  
63,00€ Kg if

## MACACO TIPO GARRAFA 20T

**50823** 94,00€

10,18 - 2 96  
Kg SUB

↑ 452mm  
↓ 242mm

**20T**



## MACACO TIPO GARRAFA 20T CARROS BAIXOS

**50824** 88,00€

8,47 - 2 120  
Kg SUB

↑ 335mm  
↓ 190mm

**20T**



## MACACO TIPO GARRAFA 30T

**50825** 154,00€

7,62 - 2 96  
Kg SUB

↑ 465mm  
↓ 285mm

**30T**



## MACACO TIPO GARRAFA 2-15T

**50819** 28,00€

2,42 - 6 330  
Kg SUB

↑ 345mm  
↓ 181mm

**2T**

**50822** 59,00€

5,60 - 4 160  
Kg SUB

↑ 460mm  
↓ 230mm

**10T**

**50820** 34,50€

3,20 - 6 300  
Kg SUB

↑ 372mm  
↓ 194mm

**3T**

**52304** 84,00€

7,20 - 2 136  
Kg SUB

↑ 365mm  
↓ 225mm

**15T**

**50821** 47,00€

4,10 - 5 200  
Kg SUB

↑ 413mm  
↓ 216mm

**5T**



## MACACO TIPO GARRAFA COM CAIXA PLÁSTICA

**51905** 34,50€

2,90 - 6 144  
Kg SUB

↑ 340mm  
↓ 185mm

**2T**



**51906** 39,00€

3,53 - 4 144  
Kg SUB

↑ 385mm  
↓ 195mm

**3T**

**51907** 48,00€

4,59 - 4 128  
Kg SUB

↑ 450mm  
↓ 215mm

**5T**



## JACK ELEVADOR 3T

**53895** 107,00€

9,15 - 1 42  
Kg SUB

↑ 330mm  
↓ 130mm

↑ 510mm

265mm

140mm



**53896** 127,00€

11,60 - 1 28  
Kg SUB

↑ 645mm  
↓ 130mm

↑ 840mm

265mm

140mm

**53897** 140,00€

13,85 - 1 21  
Kg SUB

↑ 1045mm  
↓ 130mm

↑ 1220mm

265mm

140mm



**53898** 148,00€

15,65 - 1 21  
Kg SUB

↑ 1320mm  
↓ 130mm

↑ 1520mm

265mm

140mm

- Material: acero 45



**DISPOSITIVO PARA ELEVACIÓN POR RODA**

**15096** 2,00 10 560  
40,00€ Kg SUB

↑ 340mm

87mm

142mm

Projetado para levantar o veículo diretamente pela roda quando uma elevação alta é necessária.



**RETENOR DA ALÇA**

**15095** 0,10 50  
13,00€ Kg SUB

↑ 125mm

62mm

16mm

Projetado para proteger a alça do macaco durante o transporte.



**SUPORTE DE MONTAGEM DE RODA**

**15093** 3,65 1 50  
38,00€ Kg SUB

↑ 175mm

175mm

158mm

Projetado para prender com segurança o macaco de cremalheira no suporte externo da roda sobresalente 4x4 quando mover fora de estrada. Se encaixa na maioria dos veículos graças à base ajustável.



**SUPORTE DO MACACO**

**15094** 1,35 5 140  
39,50€ Kg SUB

↑ 293mm

293mm

10mm

Projetado para fornecer estabilidade e evitar que o macaco afunde em solo macio, aumentando a área de suporte.



## CONJUNTO DE 2 PREGUIÇAS

**53779** 36,00€

5,05 - 1 72  
Kg SUB if

195mm 205mm

430mm  
290mm

**3T** **2 PCS**



TUV GS CE

**53845** 64,00€

9,35 - 1 30  
Kg SUB if

230mm 260mm

610mm  
370mm

**6T** **2 PCS**



TUV GS CE

**54143** 249,00€

35,50 - 1 12  
Kg SUB if

500mm  
700mm

**12T** **2 PCS**



TUV GS CE

## MACACO DE TESOURA

**53218** 26,00€

2,25 - 6 216  
Kg SUB if

**1,5T** 370mm  
90mm

CE



- Adequado para todos os carros.

## PREGUIÇA DE ALUMÍNIO

**53200** 69,00€

4,70 - 1 72  
Kg SUB if

CE

385mm  
245mm

**3T**



**54144** 298,00€

28,00 - 1 18  
Kg SUB if

338mm  
500mm

**22T**

**2 PCS**

CE



**54145** 377,00€

1,80 - 1 4  
Kg SUB if

482mm  
775mm

**10T**

**2 PCS**

CE



**54146** 492,00€

2,00 - 1 4  
Kg SUB if

736mm  
1212mm

**10T**

**2 PCS**

CE



## CONJUNTO DE PREGUIÇAS 1,8 T

**54147** 198,00€

0,80 - 1 6  
Kg SUB if

1200mm  
2146mm

**1,8T**

**1 PCS**

CE



## MACACO HIDRÁULICO DE FOSSA 0,5T

**54001** 285,00€

28.50	-	1	20
Kg	sub	ff	ff

↑1.900mm  
↓1.100mm

900mm

**500 KG** CE

- Faixa de elevação de 116 a 197 cm.

- Permite levantar e mover caixas de velocidades, diferenciais, depósitos, etc. de forma segura e estável.

- Apoio de posição dupla. Levantamento fácil e rápido com pedal.

- Válvula com mola para descida controlada.

### JOGO DE 4 RODAS

**15526** 3,00 25  
48,00€ Kg ff

### PISTÃO SUBSTITUIÇÃO

**15527** 15,00 -  
276,00€ Kg ff

### SUPORTE DE DUPLA POSIÇÃO

**15528** 1,95 -  
39,00€ Kg ff

2 POSIÇÕES



COM VÁLVULA DE SEGURANÇA

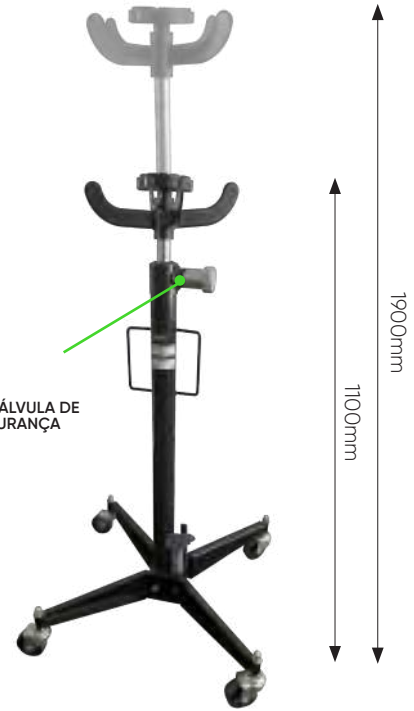

## MACACO HIDRÁULICO DE FOSSA

**50830** 560,00€

52.10	-	1	6
Kg	sub	ff	ff

- Com empunhadura
- Rápido
- Pistão duplo

**500 KG**

↑1.740mm  
↓850mm

CE



SUPORTE DE DUPLA POSIÇÃO PARA 50830

**14929** 1,95 10  
35,00€ Kg ff

Conveniente para armazenar instrumentos adquiridos separadamente.

PISTÃO SUBSTITUIÇÃO PARA REF. 50830

**12046** 28.50 -  
385,00€ Kg ff

ABRÇAÇADEIRA PARA REF. 50830

**10962** 10,60 -  
85,00€ Kg ff

## BOMBA HIDRÁULICA MANUAL

**54257** 318,00€

11.40	-	1	32
Kg	sub	ff	ff

Pressão de funcionamento:  
Etapa 1: 0-20 kg/cm<sup>3</sup>  
Etapa 2: 20-700 kg/cm<sup>3</sup>

Fluxo:  
Etapa 1: 13cc  
Etapa 2: 2.3cc



3/8" NPT

1,8m

1000 PSI

CE



## PORTA RODAS HIDRÁULICO

51901 999,00€

75,00	-	1	10

- Comprimento: 1040 mm
- Largura: 1090 mm
- Altura: 890 mm
- Faixa de elevação: 50-100 mm
- Máx. diâmetro da roda: 1320 mm

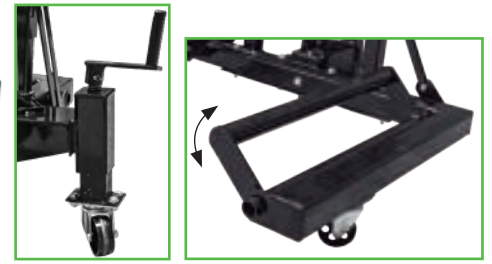

## PORTA RODAS HIDRÁULICO

52241 1.690,00€

139,00	-	1	5

- Carga útil: 1,5 t
- Faixa de elevação: 0-770 mm
- Comprimento total: 1270 mm
- Largura total: 990 mm
- Altura total: 1340 mm
- Diâmetro máximo da roda: 2200 mm (86")
- Diâmetro mínimo da roda: 1000 mm (39")
- Largura máxima da roda: 800 mm



O DESIGN FORNECE UM GANCHO SUPERIOR PARA ESTABILIZAÇÃO DURANTE O TRANSPORTE

AS RODAS NÃO DEIXAM MARCAS NA SUPERFÍCIE DEVIDO AO USO DE REVESTIMENTO DE PU RESISTENTE AO DESGASTE

## DOBRADORA DE TUBOS

50835 290,00€

35,50	-	1	14

PARA UTILIZAÇÃO HORIZONTAL E VERTICAL

- Dobra tubos até 2" (50mm).
- Construção de aço.
- Barra de flexão ajustáveis.
- Pressão: 0,75 - 0,75mpa.
- Tamanho cunhas 1/2", 3/4", 1", 1-1/4", 1-1/2", 2".



PISTÃO

13870	6,70	1
82,00€		

CONJUNTO DE CARIMBOS FLEXÍVEIS 6 PÇS

15255	8,75	1
114,00€		

## PRENSA HIDRÁULICA 30 TON

53684 1.880,00€

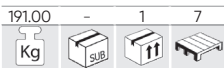

- Capacidade (T): 30.00.
- Curso (mm): 145.
- Faixa operacional (mm): 58-1018.
- Largura do assento (mm): 540.



ACCIONADO MANUAL E COM PÉ

## PRENSA HIDRÁULICA 20 TON

53590 1.190,00€

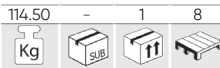

- Capacidade (T): 20.
- Curso (mm): 145.
- Faixa operacional (mm): 58-1018.
- Largura do assento (mm): 540.
- Largura interior (mm): 536.
- Curso lateral (mm): 180.



PISTÃO COM DESLOCAMENTO HORIZONTAL



GUINCHO MANUAL PARA AJUSTAR A ALTURA DA MESA DE TRABALHO



2 VELOCIDADES

## GRADE PROTETORA PARA PRENSA HIDRÁULICA

14616 96,00€

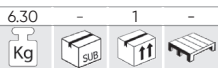

PISTÃO  
15044  
259,00€

ALAVANCA  
15048  
5,00€

MANÔMETRO  
15046  
47,00€

CERCA DE GRADE  
14616  
96,00€

MANÔMETRO  
15047  
47,00€

PISTÃO  
15043  
195,00€

ALAVANCA  
15048  
5,00€

BOMBA  
14639  
195,00€

## BASE DE TRABALHO PARA PRENSA

52999 168,00€



BLOCO GRANDE



BLOCO PEQUENO





## GRUA DE 2T DROBRÀVEL

**50831** 460,00€

79,50 Kg 1 20

Altitude: 180cm (2T) - 2,19m (1/2T)  
 - Dimensão flexada: 800 x 680 x 1.600mm.  
 - Capacidade:  
 Posição 1: 2T - 80mm.  
 Posição 2: 1/2T - 255mm.  
 Posição 3: 1T - 425mm.  
 Posição 4: 1/2T - 610mm.

↑ 1.460mm    1.060mm    1.750mm

2T

CE

↑ 2.620mm  
↓ 60mm

## GRUA DE 1T DROBRÀVEL

**52985** 598,00€

74,00 Kg 1 9

1T

CE

146cm

46cm

60cm

(Min./Max.): 82/105cm

95cm

133cm

RODAS GIRATÓRIAS  
PARA REF. 50831

**12032** 7,50€

5,20 Kg 6

PISTÃO  
SUBSTITUIÇÃO  
PARA REF. 50831

**14090** 103,00€

110,30 Kg 1

JOGO DE PARAFUSOS  
PARA A REF. 50831

**11323** 16,00€

2,04 Kg 1

PISTON DE REPO-  
SIÇÃO PARA 52985

**13672** 220,00€

10,82 Kg 1

ANEL DE VEDAÇÃO DO  
PISTÃO - REF. 52985

**14589** 2,50€

0,10 Kg 100

## SUPORTE ALINHADOR DE MOTOR

**50631** 68,00€

6,30 Kg 1 100

GRUA NÃO INCLUIDO.

750 KG

CE

## COMPRESSOR DE MOLAS PARA AMORTECEDORES

**50827** 387,00€

32,90 Kg 1 15

1T

CE

190mm

350mm

830mm

200-500mm

- Capacidade: 1T (2200 lbs)  
 - Diâmetro da mola comprimida: 200mm  
 - Comprimento de compressão: 200-500mm

## GUINDASTE MANUAL

	54262	54263	54264
Altura de elevação	2,8M	2,8M	2,8M
Talha de corrente	1	2	2
Dimensões da corrente	Corrente de carga: 6x30mm	Corrente de carga: 6x30mm	Corrente de carga: 6x30mm
	Corrente manual: 4,5x25mm	Corrente manual: 4,5x25mm	Corrente manual: 4,5x25mm
Comprimento	Corrente de carga: 3m	Corrente de carga: 3m	Corrente de carga: 3m
	Corrente manual: 2,5m	Corrente manual: 2,5m	Corrente manual: 2,5m
Esforço para levantar a carga máxima	304N	310N	361N
Material	Corrente de carga: Aço 20Mn2	Corrente de carga: Aço 20Mn2	Corrente de carga: Aço 20Mn2
	Corrente manual: Aço Q235	Corrente manual: Aço Q235	Corrente manual: Aço Q235

**54262** 88,00€

8,50 Kg 1

1T

**54263** 130,00€

12,00 Kg 1

2T

**54264** 240,00€

33,00 Kg 1

5T

## SUPORE PARA MOTORES

**50840** 138,00€

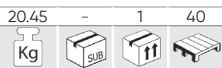

1750mm



ENGATE E MANIVELA PARA REF. 50840

**51452**

69,00€

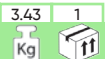

**53682** 98,00€

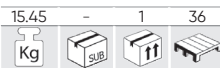

1480mm



## SUPORE DE MOTOR UNIVERSAL

**52055** 129,00€



- Adaptável a todo tipo de carros e carrinhas.
- Ideal para a troca da correia de distribuição, das correias auxiliares, ou caixa de velocidades.
- Suporte ideal de trabalho quando se retira o sub-chassis.
- Rápida colocação, com necessidade de um só operário.
- Colocação e acesso pela parte inferior.
- Peça perpendicular com ângulo giratório e ajustável a qualquer altura da barra longitudinal.
- Altura dos ganchos ajustável com 360° de rotação.
- Platina plástica de apoio para evitar o movimento do ponto de apoio da barra.



## SUPORE PARA MOTORES

**50836** 148,00€



850mm

900mm

800mm



**50838** 299,00€



900mm

1,100mm

900mm



- Dimensão fexada: 100 x 50 x 44cm.



## ELEVADOR DE MOTAS

**53969** 96,00€



328mm

293mm

400mm  
300mm

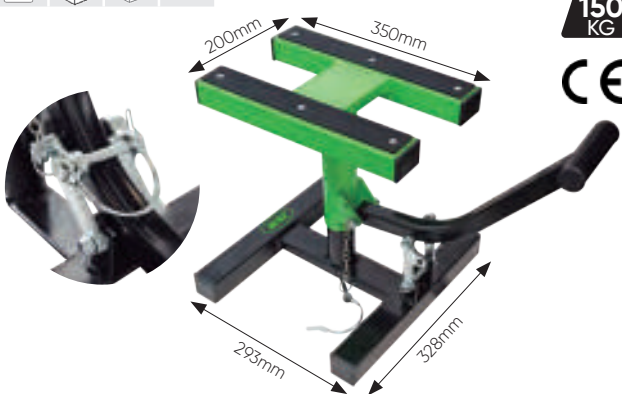

## MESA PARA MOTAS

**52692** 129,00€



400mm  
95mm



- Acionamento com chave de 21mm.





## MESA HIDRÁULICA 360KG

53246

1.144,00€

104.00	-	1	4

↑ 1.350mm  
↓ 370mm

360  
KG



## MESA ELEVADORA PARA MOTAS

50630

590,00€

480mm 840mm

↑ 780mm  
↓ 290mm

400  
KG



63.00	-	1	4

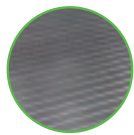

PISTÃO SUBSTITUIÇÃO  
PARA REF. 50630

10993 8.80 1  
117,00€ Kg

PISTÃO DE SUBSTITUIÇÃO  
PARA MESA HIDRÁULICA  
REF. 50630

11950 0.03 1  
18,00€ Kg

## MESA HIDRÁULICA PARA MOTAS

50911

788,00€

↑ 780mm  
↓ 205mm

365  
KG



135.00	-	1	5



CONJUNTO DE 2 RODAS  
COM TRAVÃO PARA 50911

14706 0.00 -  
8,90€ Kg

PISTÃO SUBSTITUIÇÃO  
PARA REF. 50911

14727 7.10 1  
108,00€ Kg

## MESA HIDRÁULICA PARA MOTAS

51750

299,00€

500mm 450mm 340mm

↑ 890mm  
↓ 340mm

135  
KG



31.00	-	1	12



## MACACO ELEVÇÃO QUAD

53423

199,00€

790mm 370mm 330mm

680  
KG



29.40	-	1	24

368mm  
118mm



ALAVANCA DE  
ELEVÇÃO

PISTÃO SUBSTITUIÇÃO  
PARA REF. 53423

14291 4.60 3  
87,00€ Kg

RODAS DE  
NYLON

## SET DE 2 RAMPA PARA ELEVAR 1T

52845 170,00€



20,00	-	1	8
Kg	sub	ff	ff

- Útil para apresentar veículos a exposição, bem como para trabalhos de manutenção a parte inferior do veículo.

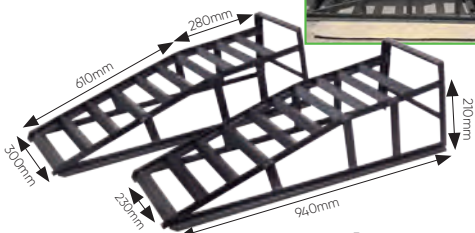

## PORTA CARROS HIDRÁULICO 680Kg

50839 180,00€



19,20	-	1	10
Kg	sub	ff	ff

- Comprimento plástico preto das extremidades: 300mm.  
- Comprimento com rodas: 600mm.



PISTÃO PARA REF. 50839

15085	5,30	1
156,00€	Kg	ff

RODAS PARA REF. 50839

12889	0,65	30
12,00€	Kg	ff

## SUPORE ELEVADOR DE MOTAS

FRENTE

52514 84,00€



4,00	-	1	26
Kg	sub	ff	ff



APOIOS PARA SUPORE DE MOTAS

PLANOS (x2)

10671	0,63	2	255mm
15,20€	Kg	ff	

TRASEIRO

51751 99,00€



5,00	-	4	12
Kg	sub	ff	ff



REDONDOS (x2)

11892	0,15	50	20mm
12,50€	Kg	ff	

## CARRO TRANSPORTADOR ESPECIAL CHAPEIROS

50923 454,00€



36,40	-	1	18
Kg	sub	ff	ff

- Separação de 0 a 110 cm.

RODAS PARA REF. 50923

12022	33,70€
-------	--------

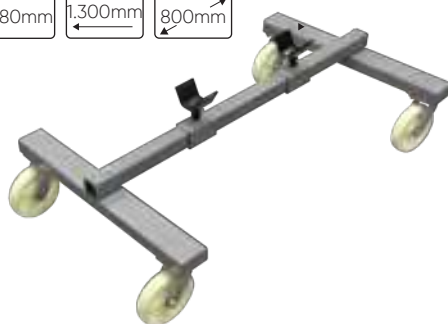

## CONJUNTO DE 4 BASES DE ELEVAÇÃO TESLA

54175 34,00€

0,80	5	20	280
Kg	sub	ff	ff

NR GAUCHO RUBBER

TESLA 3/X/S/Y



## PORTA PALETES MANUAL ELEVÇÃO RÁPIDA

53880 598,00€



84,50	-	1	6
Kg	sub	ff	ff

- Capacidade de levantamento: 2500kg  
- Comprimento do empurrador: 1150mm  
- Alça: Quadrado, emborrachado  
- Volante (giratório): PU(200x50mm)  
- Roda fixa: Duplo, PU (80x70 mm)  
- Min. altura de forquilha: 85mm  
- Máx. altura de foquilha: 200mm  
- Número de cursos do pistão da bomba: 8



AÇÃO RÁPIDA (AÇO FUNDIDO)

PU 80x70mm

ROLO DE FORQUILHA

14938	1,00	10
42,00€	Kg	ff

VOLANTE

14939	2,60	4
57,00€	Kg	ff

UNIDADE HIDRÁULICA

14940	9,35	1
248,00€	Kg	ff

CONJUNTO DE 2 PINOS PARA EIXO DA ALÇA

14785	0,5	-
3,50€	Kg	ff



270

## EMPILHADOR DE PALETES ELÉCTRICO

53777 4.352,00€

133,50	-	2	2
Kg	sub	ff	ff



DESIGN INOVADOR  
- Unidade hidráulica selada  
- Manutenção fácil  
- Baixo nível de ruído  
x2 chaves  
RODA PU / PV

1.390mm

0,25Kw/h

4,5km/h



115mm





## FERRAMENTAS ELÉTRICAS

- 272 ARRANCADORES DE BATERIAS
- 273 CARREGADORES  
/ COMPROVADORES DE BATERIA
- 274 MEDIDORES DE CORRENTE
- 275 TERMÔMETROS
- 276 ENDOSCÓPIOS
- 277 SOLDADORES
- 278 AMOLADORA DE MESA
- 279 LIMPADORES DE PEÇAS
- 280 ASPIRADORES
- 281 AQUECEDORES  
/ ROBÔ CORTADOR DE RELVA
- 282 LAVADORA DE ALTA PRESSÃO
- 283 EXTENÇÕES ELÉTRICAS
- 284 VENTILADORES

# CABOS DE ARRANQUE

## PINÇA MACIÇA DE LATÃO

REF.	Ø CABO + TAMPA	LONGO	A	SECÇÃO	Kg			€
51238	17mm	5m	700	70mm <sup>2</sup>	4,95	2	84	138,00€
51239	15mm	7m	700	70mm <sup>2</sup>	5,90	2	72	159,00€



## PINÇA DE LATÃO

REF.	Ø CABO + TAMPA	LONGO	A	SECÇÃO	Kg			€
52069	11mm	2,5m	250	25mm <sup>2</sup>	1,55	10	240	29,50€
52070	12mm	3m	350	35mm <sup>2</sup>	1,95	5	160	40,00€
52071	13mm	3m	500	50mm <sup>2</sup>	2,35	5	90	47,00€



## PINÇA MACIÇA DE LATÃO COM PROTETOR DE SOBRECARGA

REF.	Ø CABO + TAMPA	LONGO	A	SECÇÃO	Kg			€
51363	12mm	3m	350	35mm <sup>2</sup>	2,63	5	120	114,00€
51365	12mm	3m	600	50mm <sup>2</sup>	3,10	5	90	118,00€



### PINÇA MACIÇA DE COBRE

14145	0,20	30
8,50€	Kg	



### PINÇA MACIÇA DE LATÃO

14147	0,35	15
25,00€	Kg	



### PINÇA MACIÇA DE COBRE

14146	0,20	30
8,00€	Kg	

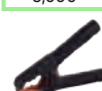

### PINÇA MACIÇA DE LATÃO

14148	0,35	15
25,00€	Kg	

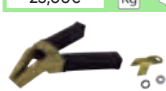

### KIT DE 2 PINÇAS DE CROCODILO

53357	0,01	6	24
7,00€	Kg		



2 PCS 30 AMP

# ARRANCADOR DE BATERIA

**53687** 298,00€

11,35	-	1	14
Kg			



**53688** 495,00€

18,05	-	1	14
Kg			

- Tensão: 12V.
- Bateria: 22 A\*h, ácido-chumbo (1 unid.)
- Corrente de partida: 750A.
- Corrente de pico: 1500A.



**53688**

- Tensão: 12V/24V.
- Bateria: 22Ah AGM de ácido-chumbo (2 unid.)
- Corrente de partida/pico de 12V: 1500A/3000A. 24V: 750A/1500A.
- Tempo de carga da bateria: Carga total da bateria: 40 h Carga até 10-20%: 6 h



Pinzas

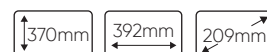

Medidor de tensão da bateria interna

Botão de verificação da tensão da bateria interna

Interruptor ligar / desligar

Toma de carga

Luz LED integrada: aumenta a visibilidade da área de trabalho

## PARTES SEPARADAS

REF.	DESCRIÇÃO	Kg		€
14755	Bateria 22 A*h para ref. 53687, 53688	6,50	2	134,00€
14756	Placa de circuito impresso para ref. 53687	0,05	10	15,20€
14757	Placa de circuito impresso para ref. 53688	0,05	10	15,20€
14758	Cabo de lançamento vermelho com um grampo no final para ref. 53687	0,40	10	18,00€
14759	Cabo de lançamento preto com um grampo no final para ref. 53687	0,40	10	18,00€
15782	Cabo de lançamento preto com um grampo no final para ref. 53688	0,30	10	16,00€
15781	Cabo de lançamento vermelho com um grampo no final para ref. 53688	0,30	10	19,84€

Cabo de lançamento preto para carregar a bateria com um grampo no final para ref.53687

**53688**



**14757**

**15781**



**14759**



**14755**



53688 53687

**53687**

**14756**



**14758**



**15782**





## ARMAZENAMENTO DE MEMÓRIA PARA A SUBSTITUIÇÃO DAS BATERIAS

**52884** 73,00€

0,25	5	20	360
Kg	Sub	ff	ff



235mm ± 20mm

2.070mm ± 20mm

- Útil para manter corrente no sistema eléctrico do veículo durante troca de bateria.
- Conexão OBDII via cabo ou isqueiro.

## CARREGADORES DE BATERIA

**6/12V**

**53927** 66,00€

0,65	5	20	240
Kg	Sub	ff	ff



**12/24V**

**53929** 95,00€

0,90	5	20	240
Kg	Sub	ff	ff



COMPATÍVEL COM BATERIAS DE CHUMBO-ÁCIDO: LÍQUIDO, HÉLIO, MF E AGM

## MEDIDOR DE ISOLAMENTO

**54114** 248,00€

1,48	-	10	100
Kg	Sub	ff	ff

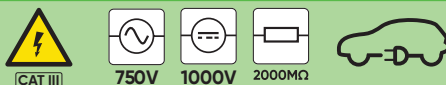

Este instrumento auxilia na medição do isolamento elétrico a uma determinada voltagem (250 V, 500 V ou 1000 V). É uma ferramenta indispensável para avaliar a integridade de um circuito elétrico, especialmente necessária para verificar que os componentes e a instalação em carros elétricos estão completamente isolados da carroçaria. Em instalações industriais, é esta a ferramenta que permite fazer inspeções periódicas à resistência do isolamento. Medições necessárias para a norma DIN VDE 0105-100 (VDE 0105-100: 2009-10).



## COMPROVADOR BATERIAS DIGITAL

**51816** 49,00€

0,30	6	48	576
Kg	Sub	ff	ff

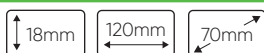

- Aplicável em baterias de 12v.
- Medição em SAE(CCA), EN, IEC, DIN, CA.
- Rango: 200~1200CAA (SAE).
- Medição de voltagem: 7V~15V.
- Display 4 + 3 Leds (verde, vermelho, amarelo).
- 150Ah.



## COMBROBADOR BATERIAS

**51235** 49,00€

1,25	-	10	150
Kg	Sub	ff	ff

- Para baterias de 6v e 12v.
- Carga até 100Ah.
- Test de Estado de carga.
- Test de Consumo de Arranque.
- Test de Voltagem da carga.
- Test do estado de la Bateria.



## COMPROVADOR DE BATERIAS E ALTERNADORES COM IMPRESSORA

**52233** 328,00€

2,32	-	6	72
Kg	Sub	ff	ff

- Aplicável a baterias de 6V e 12V.
- Sistemas de carga encendido de 12V e 24V.
- Alcance de operação: 40 - 2000 CCA (SAE).

- Voltímetro: 1.5V - 30V.
- Jogo de cabos de 180cm.
- Inclui: Pilhas 6x1.5AA, 1 rolo de papel térmico.



COM IMPRESSORA

AGM, GEL, VRLA, SLI

## DENSÍMETRO DE BATERIAS

**53209** 8,50€

0,14	24	96	768
Kg	Sub	ff	ff

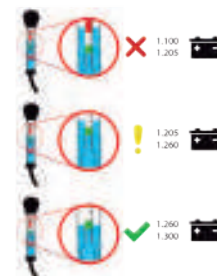

PAPEL TÉRMICO 57mmx60m

<b>51842</b>	0,10	6	72
6,90€	Kg	Sub	ff

IVA não incluído

# COMPROVADOR DE BATERIAS E ALTERNADORES COM IMPRESSORA

**54040** 240,00€

0,90 - 10 100  
Kg SUB

- Aplicável a baterias de 12 V, AGM (tapete de vidro absorvente), GEL (gel), VRLA (ácido de chumbo regulado por válvula), SLI (com eletrólito líquido).
- Faixa de operação: 100-2.000 corrente de partida a frio CCA (SAE)
- Idiomas disponíveis do sistema: Espanhol (ES), Inglês (EN), Francês (FR), Alemão (DE), Italiano (IT), Português (PT), Romeno (RO).
- Aplicável para sistemas de partida 12/24 V.
- Aplicável a baterias de 12 V, AGM (tapete de vidro absorvente), GEL (gel), VRLA (ácido de chumbo regulado por válvula), SLI (com eletrólito líquido).
- Testador de arrancadores e alternadores.
- \* Uma bateria CR2032 incluída

Aplicable a baterias de 12V AGM GEL VRLA SLI

Aplicable a sistemas de arranque de 12V 24V

x1 CR2032 Incluídas

-20°C 50°C

100 - 2000 CCA (SAE)



COM IMPRESSORA

## PINÇA AMPERIMÉTRICA

**52382** 19,50€

0,23 5 50 1600  
Kg SUB



- FUNÇÕES:  
Teste fio vivo.

- Instrumento ideal para electricistas.
- Pode-se medir: voltagem AC, voltagem DC, Corrente AC, resistência, diodo, frequência.
- Entorno de funcionamento: 0°C a 40°C, a <80%RH.
- Entorno de armazenagem: -10°C a 40°C, a <85%RH.

**52952** 74,00€

0,26 5 50 1500  
Kg SUB



- FUNÇÕES:  
Teste fio vivo.  
Teste de diodo.  
Teste de continuidade.  
Função ADP.  
Função de detecção de fase.  
Interruptor ZERO.

- Alimentação: 2 pilhas tamanho AAA.
- Indicador de bateria baixa.
- Écra de 3,5" com 4 dígitos.
- Função de corrente contínua.
- Medição de voltagem AC/DC.

	52382	52952
DCB	600V	20V, 600V
ACB	600V	600V
DCA		200A
ACA	20A, 200A, 600A	200A
OHM	2KΩ, 200KΩ, 2MΩ	2000Ω



52382



52952

167mm

55mm

22mm

## MULTÍMETRO DIGITAL

**50942** 28,00€

0,35 10 60 480  
Kg SUB

- Autoapagado.
- Indicador de bateria.
- Baterias de 9 V.
- Sonda de temperatura.
- Temperatura de -40 °C a 1000 °C.

- Dígitos: 3 1/2.
- Medição: 2 000.
- Dados instantâneos.



CON PROTECTOR LATERAL



V AC	200mV, 2V, 20V, 200V, 1000V	A AC	20mA, 200mA, 20A
V DC	200mV, 2V, 20V, 200V, 750V	A DC	20mA, 200mA, 20A
Ω	200Ω, 2KΩ, 20KΩ, 200KΩ, 2MΩ, 20MΩ, 2000MΩ		
F	2nF, 20nF, 200nF, 2μF, 20μF, 200μF		

CE

## JOGO DE CABOS E ACC. PARA REF. 50942

**52439** 227,00€

3,26 - 5 40  
Kg SUB

- 2 medidores de resistência variável.
- 2 luzes led de comprovação.
- 2 SRS substituição e dois dispositivos de proba.
- 2 alicates de crocodilo.
- 2 tomas de engate rápido.
- 4 sondas.
- 24 conectores redondos.
- 48 conectores lisos.



CE



## KIT DE ACESSÓRIOS PARA MULTÍMETRO

**52231** 49,00€

0,41	5	20	240
Kg	Sub	ff	ff

- Este kit é apto para a maioria de multímetros.

- Inclui:  
2 sondas.  
2 pinças pequenas.  
2 pinças largas.  
cabos de extensão.



## PROTECTOR DE PICOS AUTOMÁTICO

**54256** 48,00€

0,45	-	20	800
Kg	Sub	ff	ff

12V  
24V

35V

800 AMP

1500W



## COMPROVADOR DE CIRCUITOS

**53028** 5,80€

0,70	10	120	1440
Kg	Sub	ff	ff

6-12-24V

1,8 x 190mm



- Adequado para verificar a polaridade.

**53029** 6,80€

0,08	12	240	2400
Kg	Sub	ff	ff

6-12-24V

2 x 115mm



**53030** 12,00€

0,17	6	60	720
Kg	Sub	ff	ff

6-12-24V

LED

3 x 142mm



## TERMÔMETRO LÁSER

**52162** 38,00€

0,17	6	72	576
Kg	Sub	ff	ff

**-50° A 550°C**

- Alcance de medição: -50° a 550 °C (58 °F a 1022 °F).
- Precisão: ± 2 °C / ± 2%.
- Opção de retro iluminação.
- Ponteiro laser.
- Medição em °C / °F.
- Emissividade: Ajustável (0,1~1,0).
- Tempo de resposta: ≤ 0,8 s.
- Possibilidade de bloqueio de medição.
- Bateria DC 9V.
- Indicador de bateria baixa.



LASER

9V

-50°C - 550°C  
-58°F - 1022°F  
± 2°C ± 2%



**52450** 105,00€

0,72	5	20	200
Kg	Sub	ff	ff

**-50° A 1.000°C**

- Termômetro de infra-vermelho.
- Leitura de: -50°C ~1000°C / -58°F ~ 1.832°F.
- Tolerância +/- 1,5°C.

- Funções:  
Indicação por ponteiro laser.  
Alarme de temperatura máxima ou mínima.  
Leitura em °C / °F.  
Função de memória de resultado.  
Indicador de bateria baixa.

9V

-50°C - 1000°C  
-58°F - 1832°F  
± 1,5°C



- Bateria de 9V incluída.

## TERMÔMETRO DIGITAL DE CONTATO

**53503** 12,00€

0,05	20	100	2400
Kg	Sub	ff	ff

1.5V

x1

-50°C - 330°C  
-58°F - 572°F  
± 0,2°C  
(± 0,2° - 90°C)



## COMPROVADOR DE FLUÍDO DE FREIO

**51839** 24,00€

0,05	25	100	2400
Kg	Sub	ff	ff

- Funciona com pilhas 1xAAA LR03.
- Com 4 níveis de qualidade medíveis de 0% a 4%.



## ENDOSCÓPIO COM WIFI

53724 46,00€

0,15 - 50 800



- Endoscópio com função de transferência de imagem Wi-Fi. Capacidade de se conectar a qualquer smartphone. Suporte para trabalhar com um tablet ou computador.

- O pacote inclui:  
**Câmara endoscópica.**  
**Transmissor Wi-Fi.**  
**Capa de gancho.**  
**Capa de imã.**  
**Capa de espelho lateral.**



2560x1920  
1280x720  
640x480

SMP

- Resolução: 2560x1920 / 1280x720 (720p 16:9) / 640x480 (480p 4:3).  
 - 20fps.  
 - 5 megapixels.  
 - Ângulo de visão: 70 graus.  
 - Diâmetro: 5,5mm.  
 - Distância focal: 4-6cm.  
 - Resistente à água IP67 (até 1 metro).  
 - Bateria de lítio 2.600mAh.

CABO SEMI-RÍGIDO DE 1M

Ø 5,5MM



FUNCIONA COM JBM APP:



ASSISTA AO TUTORIAL EM VÍDEO  
 YouTube

## ENDOSCÓPIO INDUSTRIAL CABLE 1m

52436 680,00€

2,41 - 5 40



- Alimentação: DC5.  
 - Monitorar 3,5TFT 320x240px.  
 - Interface: MINI USB 1.1/AV.  
 - Bateria recarregável Li-Polymer 3.7V.  
 - Adaptador: 100-240V.  
 - Saída AC 5VDC.  
 - Vídeo em NTSC&PAL.  
 - Armazenamento: CARD SD (até 32Gb).  
 - Compressão: JPG.  
 - Gravação: MPEG4 (640x480).  
 - Temperatura de trabalho: -20°C - 60°C.  
 - Temperatura de armazenamento: 0°C - 40°C.  
 - Diam. cablu: 5mm.  
 - Funções: a saída de vídeo, 6 idiomas, auto-off, fotos, vídeos, data/hora.



VISOR A CORES

1M

PONTA PARA ENDOSCÓPIO

11992 0,01 20  
65,00€ Kg ff

CABLE 3m

11219 0,32 1  
659,00€ Kg ff

CABLE 1m

11329 0,22 1  
564,00€ Kg ff

## DETECTOR DE VAZAMENTO DE GÁS

53484 615,00€

4,70 - 4 32



- ÓLEO NÃO INCLUIDO.



ÓLEO 500ML POR REF. 53484  
 14081 0,50 48 960  
12,60€ Kg ff

TUBO DE REPOSIÇÃO PARA 53484

14109 0,01 20  
29,00€ Kg ff

BOMBA INFLADORA PARA 53484

14110 0,20 20  
110,00€ Kg ff



Inclui:



## PISTOLA DE COLA TERMOFUSÍVEL

51831 24,00€

0,35 12 36 288



- Voltagem: 100~ 230 V.  
 - Temperatura: 190~230 °C.  
 - Consumo: 60~150 W.  
 - Diâm. de boca: 2,0~2,3 mm.  
 - Alcance: de 8 a 16g de producto / minuto.



ADHESIVO TERMOFUSÍVEL

51859 0,12 8 32 1520  
3,80€ Kg SUB ff

- Ø 8mm.  
 - Pegam rapidamente todo tipo de materiais flexíveis.  
 - Tempo de secado 20'.





## SOLDADOR

**53977** 17,50€

0,30	12	48	576
Kg	Sub	U	U

- Tensão 220-240 V
- 40 W
- Frequência: 50Hz
- Comprimento: 240mm
- Cabo: 1,3 m
- Temperatura máxima de trabalho: 450° +/- 10%



**53111** 19,00€

0,30	5	25	625
Kg	Sub	U	U

- Voltagem: 220-240V.
- Temp.: 420°C +/- 10%.
- Largo: 250mm.
- Cable: 1,5m.



## MÁQUINA DE SOLDA INVERTER MMA

**53981** 143,00€

**100A DC**

3,35	-	1	90
Kg	Sub	U	U

- Pode ser usado para soldar peças de aço e ferro com todos os tipos de eletrodos ácidos e alcalinos.
- Ferramenta compacta, leve e economizadora de energia.
- Alta qualidade de ignição de arco e potência de arco, arco estável e poucos respingos.
- Soldagem de alta qualidade, alta profundidade de penetração.
- Proteção automática contra sobretensão, sobre-corrente e superaquecimento.
- A tecnologia IGBT melhora significativamente a confiabilidade do dispositivo.
- Ela fornece equalização automática quando a tensão de entrada flutua.



- ✓ INVERSOR COM TECNOLOGIA IGBT
- ✓ SOLDAGEM MANUAL DC SOLDAGEM A ARCO
- ✓ PROTEÇÃO CONTRA QUEIMAD+H5URA
- ✓ POTÊNCIA DO ARCO
- ✓ IGNIÇÃO DE ARCO QUENTE

- Completa:
- Porta-eletrodo com cabo de 2m.
- Pinça de aterramento com cabo de 1,5m.
- Escova de martelo.
- Máscara facial manual.

1ph AC 230V	50Hz	3.7 KVA	16A	65V
100A 24V	10-100A	0.7	IP21S	F



REPOSIÇÃO PARA REF. 51837

REF.	DESCRIÇÃO	€
15237	Porta-eletrodo com cabo de 2m	12,00€
15238	Escova de martelo de soldador	5,00€
15239	Protetor facial manual	5,50€
15240	Pinça de aterramento com cabo de 1,5m	9,50€
15241	Painel de junção	65,00€
15242	Conexão de acoplamento rápido (negativa/positiva)	2,50€
15243	Ventilador	4,00€
15244	Interruptor de alimentação	2,00€

**53982** 219,00€

**160A DC**

6,10	-	1	33
Kg	Sub	U	U

- Muito utilizado para soldagem de decoração de interiores e trabalhos em altura.
- Compacidade, estabilidade e confiabilidade.
- Fácil acesso ao arco, poucos respingos e formação estável.
- A tecnologia IGBT melhora significativamente a confiabilidade do dispositivo.
- Eletrodos básicos e rutilicos podem ser usados.
- Alta tensão sem carga e potência do arco.
- Proteção automática contra sobretensão, sobre-corrente e superaquecimento.
- Corrente de soldagem estável com tensão de entrada flutuante e capacidade de equalização automática com tensão de entrada flutuante.



- ✓ INVERSOR COM TECNOLOGIA IGBT
- ✓ SOLDAGEM MANUAL DC SOLDAGEM A ARCO
- ✓ PROTEÇÃO CONTRA QUEIMAD+H5URA
- ✓ POTÊNCIA DO ARCO
- ✓ IGNIÇÃO DE ARCO QUENTE

- Completa:
- Porta-eletrodo com cabo de 2m.
- Pinça de aterramento com cabo de 1,5m.
- Escova de martelo.
- Máscara facial manual.

1ph AC 230V	50Hz	16A	65V	6.5 KVA
160A 26.4V	IP21S	10-160A	0.7	F



REPOSIÇÃO PARA REF. 51837

REF.	DESCRIÇÃO	€
15238	Escova de martelo de soldador	5,00€
15239	Protetor facial manual	5,50€
15245	Pinça de aterramento com cabo de 1,5m	7,50€
15246	Painel de junção	108,00€
15247	Conexão de acoplamento rápido (negativa)	2,50€
15248	Conexão de acoplamento rápido (positiva)	2,50€
15249	Ventilador	5,00€
15250	Interruptor de alimentação	4,50€
15251	Porta-eletrodo com cabo de 2m	15,00€

## PISTOLA DE CALOR 2000W

**53145** 39,20€



- 220V-240V.  
- 50Hz-60Hz.  
- 2000W.



- Temperatura de saída: 50-600°C.  
- Fluxo de ar: 220-480L/min.  
- 2 opções de temperatura: 300 i 600°C.

**53162** 60,00€

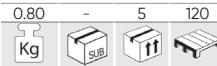

- 220V-240V.  
- 50Hz-60Hz.  
- 2000W.



- Temperatura de saída: 100-600°C.  
- Fluxo de ar: 280-480L/min.

DIGI-TAIS

## RISCADOR DE PNEUS

**52643** 596,00€

POTÊNCIA MÁXIMA: 350W

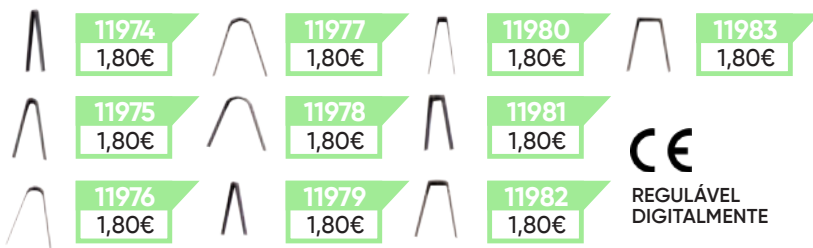
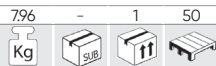

CE  
REGULÁVEL  
DIGITALMENTE

### REPUESTOS

REF.	11974	11975	11976	11977	11978
CUTTER TIPO	R1	R2	R3	R4	R5
LÂMINA REDONDA	mm	mm	mm	mm	mm
A	3	5	6	8	10
B	7	7	10	12	12
C	5	8	15	16	18
D	21	21	23	25	24

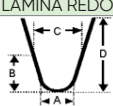

REF.	11979	11980	11981	11982	11983
CUTTER TIPO	W1	W2	W3	W4	W5
LÂMINA QUADRADO	mm	mm	mm	mm	mm
A	3	5	7	9	11
B	7	7	10	12	12
C	5	6	10	13	15
D	21	21	22	24	23

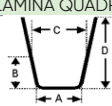

## AMOLADORA DUPLA ELÉTRICA

450W

600W

250W

250W

**53656** 198,00€

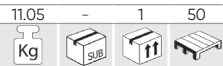

230V  
450W  
2950 RPM  
50Hz



**53657** 248,00€

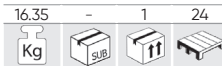

230V  
600W  
2950 RPM  
50Hz



**53658** 99,00€

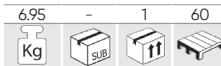

230V  
250W  
2950 RPM  
50Hz



**53659** 121,00€

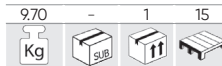

230V  
250W  
2950 RPM  
50Hz

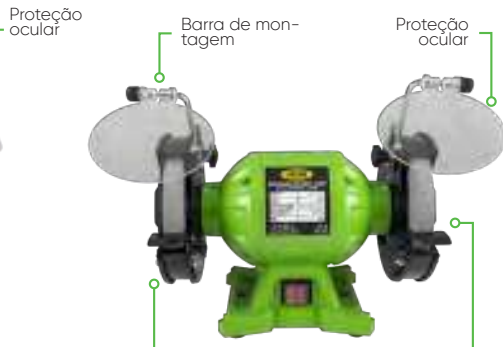

Botão de fixação do suporte

Rebolo

Tampa protetora

Rebolo



Tanque de água

Rebolo sem resfriamento



## BASE METÁLICA PARA AMOLADORA DE BANCADA

**53660** 146,00€

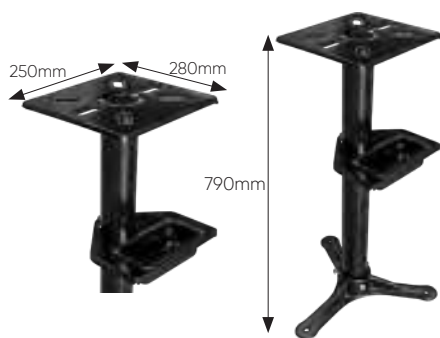

- Altura: 790mm.
- Dimensões da placa de fixação: 250x280mm.

## AMOLADORA DUPLA ELÉCTRICA 150mm

**52195** 170,00€

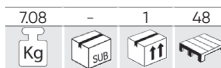

- Potência nominal entrada 250w.
- Tensão nominal 230v / 50hz.
- Velocidade sem carga 2950rpm.
- Diâmetro da roda 150 x 20 x 12,7mm



## TANQUE DE LIMPEZA DE PEÇAS

**52980** 480,00€

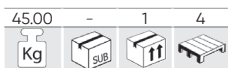

**150L**

- Caudal: 25L.
- Funciona com soluções de limpeza de motor solúveis em água.

MEDIDAS TOTALES MÁQUINA

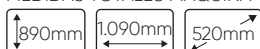

MEDIDAS INTERIORES DEPÓSITO

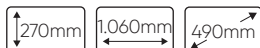

REPOSIÇÃO DE BOMBA



**11101** 154,00€

FILTRO REPOSIÇÃO

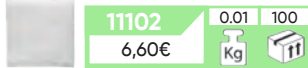

**11102** 6,60€

**50632** 298,00€

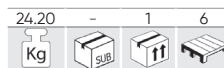

**100L**

MEDIDAS TOTALES MÁQUINA



MEDIDAS INTERIORES DEPÓSITO



PINCEL REPUESTO



**11100** 24,30€

## LIMPADOR DE PEÇAS PORTÁTIL

**53220** 260,00€



- FORMATO PORTÁTIL.
- Permite o fecho estanque para evitar perdas durante o transporte.
- Usar com solvente de base aquosa.

- Tomada de acendido lateral.
- Filtro de limpeza de líquido incluído.
- Gancho de ferramentas e de mangueira incluído.
- Compartimento de armazenamento.
- Separação de áreas de trabalho, área de limpeza e área de secagem, aceita o trabalho com varias peças a tudo de uma vez.

- Capacidade máxima: 27,5 l.
- Capacidade de bombeamento: 1.000 L/h.
- Capacidade de trabalho: 20L.
- Conexão a 220V.
- Mangueira de 1,10m de longo.



IVA não incluído

# ASPIRADOR INDUSTRIAL

**51837** 195,00€

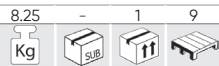

**30L**

SECO DE 30L



INCLUI



REPOSIÇÃO PARA REF. 51837

REF.	DESCRIÇÃO	€
10720	Mangueira plástico 1,5m	24,50€
11095	Mangueira plástico 3m	31,00€
10721	Tube de metal extensível	19,00€
10761	Filtro	16,00€

**51838** 667,00€



**80L** CE

SECO + HÚMEDO 80L



INCLUI



REPOSIÇÃO PARA REF. 51838

REF.	DESCRIÇÃO	€
10722	Mangueira plástico 1,5m	24,50€
11098	Mangueira plástico 6m	57,00€
10723	Ponta superior	29,50€
10724	Ponta inferior	29,50€
10762	Filtro	23,50€

	51837	51838
Volume (L)	30	80
Volume de sucção por segundo (L/s)	26	50
Potência	1x1.200W	3x1.000W
Tensão	230V	230V
Frequência	50Hz	50Hz
Sucção	> 17Kpa	> 20Kpa
Ø mangueira	32mm	48mm
Comprimento da mangueira	1,5m	2m
Comprimento do cabo	4,5m	4,5m
Vedação	IPx4	IPx4

# VARREDORA DE IMPULSO MANUAL

**54252** 199,00€



650X15mm



	€
16165 FIVELA DE PASSAGEM DE DISCO PARA REF. 52452	2,00€
16166 ESCOVA DE DISCO VARREDOR PARA REF. 52452	23,50€
16167 CONJUNTO DE 2 RODAS DE 50MM PARA REF. 54252	7,00€
16168 CORREIA DE TRANSMISSÃO PARA REF. 54252	5,00€
16169 PINHÃO DIREITO PARA REF. 54252	1,50€
16170 PINHÃO ESQUERDO PARA REF. 54252	1,50€
16171 CONJUNTO DE 2 RODAS DE 200MM PARA REF. 54252	20,50€
16172 HASTE DE EMPURRAR PARA REF. 54252	22,50€
16173 BRAÇADEIRA DE BARRA REF. 54252	3,00€

# PULVERIZADOR INDUSTRIAL

**53820** 388,00€

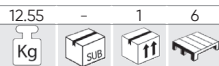

Capacidade do tanque	15L
Distância de pulverização	8-10m
Tamanho de partícula líquida	<50 microns (µm)
Capacidade do tanque de combustível	2L
Consumo de gás	3,2L/h

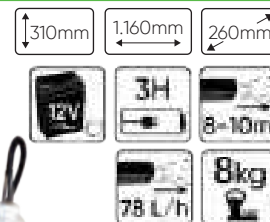

CE

- ALTA EFICIÊNCIA:  
x7-10 vezes maior que o pulverizador manual

- BOA DIFUSÃO:  
economiza água e pesticidas

- DESINFECTA UMA AMPLA COBERTURA  
através de finas partículas de fumaça



# AQUECEDOR

<b>54229</b> 48,00€ 1.76 Kg, 4 SUB, 4 IT, 80 m 210-160-217mm 2Kw, 220V/240V, 5000 MOOD, 20m² SPCC, PTC, 197 m³/h	<b>54230</b> 68,00€ 3.10 Kg, 1 SUB, 1 IT, 56 m 210-160-217mm 3Kw, 220V/240V, 5000 MOOD, 30m² SPCC, PTC, 197 m³/h	 <p>54229/54230</p>
<b>54231</b> 138,00€ 4.80 Kg, 1 SUB, 1 IT, 27 m 300-235-345mm 5Kw, 380v/400v, 5000 MOOD, 48m², SPCC 1,4m, PTC, 588 m³/h	<b>54232</b> 248,00€ 7.90 Kg, 1 SUB, 1 IT, 12 m 395-307-455mm 9Kw, 380v/400v, 5000 MOOD, 80m², SPCC 1,4m, PTC, 1180 m³/h	 <p>54231/54232</p>

# ROBÔ CORTA-RELVA

**52598** 1.080,00€

1700 Kg, 1 SUB, 1 IT, 12 m

- Robô cortador de grama autônomo.  
- Sem fio e fácil de guardar.

ALTURA DE CORTE: 2,5 - 5,5CM

LARGURA DE CORTE: 18CM

VELOCIDADE DE ROTAÇÃO DA LÂMINA: 3500RPM

5200 mAh, 1400m², 115,44W, 2,5H, 2H, 70 dB, IP X4, 7,5kg, 22m/min, 50-33,5-24 cm

CONEXÃO DE APP





REF.	DESCRIÇÃO	€
15424	Fio de conexão 150m	105,00€
15425	Suportes para fio de conexão 150 pçs	50,00€
15426	Lâmina de corte e parafusos	10,00€
15427	Pregos da estação de instalação	9,00€
15428	Bateria 22,2 v, 2 600 mah	238,00€
15429	Fio de extensão 5 m	23,50€
15430	Adaptador	83,00€
15431	Estação de carregamento	241,00€
15432	Tomada do fio de conexão	18,50€
15433	Garagem	197,00€
15434	Motor da roda traseira	147,00€
15435	Placa de corte e placa de proteção	24,50€
15436	Motor de corte	97,00€
15437	Mãe placa (com função wifi)	305,50€
15438	Sensor do fio de conexão	31,00€
15439	Rodas dianteiras	52,00€

# LAVADORA DE ALTA PRESSÃO

Esta lavadora de alta pressão com motor de 1400 W / 2400 W é ideal para limpar bicicletas, carros, equipamentos externos, pátios, terraços, estufas e muito mais.

**53947** 145,00€

5,80 - 1 31  
Kg SUB IT



## MOTOR

**15398**  
75,00€

- 10  
SUB IT

- Pressão nominal: 70 bar
- Fluxo: 5,5 L/min
- Máx. pressão de entrada: 4 bar
- Tamanho: 28x25,5x44 cm
- Tipo de motor elétrico: escova

- Incluído:  
1 spray  
1 mangueira de alta pressão 3 m  
1 cabo de alimentação 5 m



**53948** 324,00€

12,10 - 1 10  
Kg SUB IT



## MOTOR

**15399**  
117,00€

- 10  
SUB IT

- Pressão nominal: 120 bar
- Taxa de fluxo: 5,5 l/min
- Máx. pressão de entrada: 4 bar
- Tamanho: 44x34,5x50,5cm
- Tipo de motor elétrico: escova

- Incluído:  
1 spray  
1 mangueira de alta pressão 8 m  
1 cabo de alimentação 5 m  
1 bocal turbo  
1 conexão transparente  
1 gerador de espuma 750ml  
1 limpador de pátio  
1 escova de pneu  
1 escova fixa



### PULVERIZADOR

**15388** 20  
33,00€ IT

### MANGUEIRA DE PVC 5M

**15389** 20  
18,50€ IT

### LIMPADOR DE SUPERFÍCIE 8 POLEGADAS

**15390** 15  
43,00€ IT

### TRAVA DE PRODUTO FIXO

**15391** 50  
13,50€ IT

### ESCOVA DO ARO

**15392** 50  
17,50€ IT

### BOCAL TURBO

**15393** 100  
12,50€ IT

### PULVERIZADOR DE ESPUMA

**15394** 50  
26,00€ IT

### CONECTOR DE MANGUEIRA

**15395** 50  
3,50€ IT



# CARRETEL DE CABO ELÉCTRICO 21M

**53585** 168,00€

8,35	-	2	34
Kg	Sub	It	Paq

**53586** 158,00€

5,15	-	2	30
Kg	Sub	It	Paq

PROTEÇÃO DIFERENCIAL DE SOBRECARGA



COM SUPORTE DE PAREDE

230V	1000W 3000W	H07RN-F 3G1.5mm <sup>2</sup>	IP 44
20 m	+	1m	



SUPORTE DE PAREDE

**14771** 10,50€

0,35	30
Kg	It

COM REPARTIDOR

# CARRETEL DE CABO ELÉCTRICO - 12M

**53584** 119,00€

5,10	-	4	48
Kg	Sub	It	Paq

**53526** 168,00€

8,35	-	2	34
Kg	Sub	It	Paq

COM SUPORTE DE PAREDE

230V	1000W 3000W	H07RN-F 3G1.5mm <sup>2</sup>	IP 44
11 m	+	1m	



SUPORTE DE PAREDE

**14774** 10,50€

0,40	10
Kg	It



COM REPARTIDOR

PROTEÇÃO DIFERENCIAL DE SOBRECARGA



BLOCO DE CABO

# EXTENÇÃO MANUAL DE CABO ELÉCTRICO

**51033** 98,00€

3,86	-	2	48
Kg	Sub	It	Paq

- Protecção de sobrecarga.  
- Protecção infantil.

25m	H07RN-F 3G1.5mm <sup>2</sup> PVC	IP 20
-----	--	----------



# EXTENSÃO DE CORRENTE ELÉCTRICA

**53166** 10,50€

0,45	5	30	600
Kg	Sub	It	Paq

3m

**53167** 12,50€

0,65	5	20	600
Kg	Sub	It	Paq

5m

**53168** 19,00€

1,20	5	10	300
Kg	Sub	It	Paq

10m



## VENTILADOR DE VEÍCULO - 12 V

53543 13,80€

0,75 5 20 160

Kg sub ff

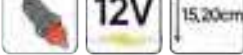
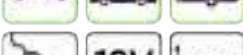

x2 VELOCIDADE



## VENTILADOR DUPLO DE CARRO

53600 13,80€

0,55 5 20 160

Kg sub ff



x2 VELOCIDADE

## VENTILADOR

DE PÉ

53189 128,00€

7,10 - 1 12

Kg sub ff



## PULVERIZAÇÃO DE ÁGUA

54125 152,00€

8,25 - 1 14

Kg sub ff

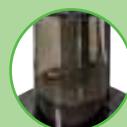
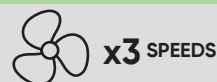

DE CHÃO

53190 98,00€

6,10 - 1 16

Kg sub ff







## **ENERGIA RENOVÁVEIS E MOBILIDADE DE AMANHÃ**

- 286 ESTAÇÃO DE CARGA PORTÁTIL
- 286 PAINEL SOLAR
- 287 CARRO ELÉTRICO / CABOS
- 288 ACESSÓRIOS
- 289 FERRAMENTAS ISOLADAS

# GERADOR DE ENERGIA 1 920 WH / 48V 40 AH

53970

3.790,00€

A estação de energia portátil é um poderoso gerador elétrico portátil que pode ser carregado com energia solar e, na ausência de luz solar, também pode ser carregado com qualquer fonte de energia.

34,70 - 1 13  
Kg SUB

Saída remota de CA Rated AC output <b>3000W</b>	Carga rápida Fast Charging 54V/10A 3-4h	Carga solar Solar Charging 54V/7.5A 4-5h	<b>220VAC</b> ± 10%
Placa de saída de CA Rated AC output <b>6000W</b>			
Capacidade de carga de baterias até 100Ah	1920Wh LiFePO4	Temperatura mínima de operação -10°C	Temperatura máxima de operação 45°C
50/60 Hz	2W(x2) LED		
USB-DC 5V/9V/ 12V/3A	DC/DC 12V/10A	USB-Type-C 5V/5A 9V/3A 12V/1.5A	USB 5V 2.4A*2
CC-CA		12V 10A	Universal
MPPT	390mm	418mm	245mm



GENERADOR DE ENERGIA

ENERGIA EM QUALQUER PARTE



INCLUI:



Carregador de bateria



Carregador solar por placa solar



Cabo de ligação por carregador de parede

VASTA GAMA DE APLICAÇÕES



3000W  
+0,75h



2000W  
+1h



1500W  
+1h



1000W  
+1,5h



120W  
+12h



200W  
+7,5h



70W  
+22h



30Wh  
+50 vezes



10Wh  
+150 vezes



100W  
+15h



20W  
+75h



2200W  
+1h



500W  
+3h



500W  
+3h



2000W  
+1h

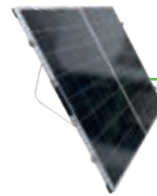

COMPATÍVEL COM 53971

# PAINEL SOLAR 200 W

53971

468,00€

13,45 - 2 12  
Kg SUB

200W

Aberto:

884mm 1320mm 54mm

Fechado:

884mm 659mm 54mm

41.82°

CONJUNTO DE 2 CONECTORES

MC4 1000V 30A

15448

5,50€



ALTA POTÊNCIA



FÁCIL TRANSPORTE

FÁCIL DE INSTALAR

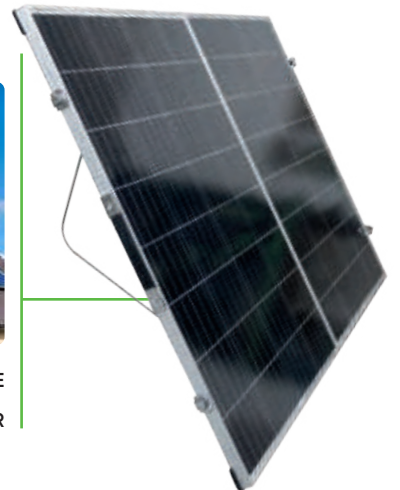

# PAINEL SOLAR

54067

599,00€

2900 - 1 31  
Kg SUB

550W

**CARACTERÍSTICAS MECÂNICAS**

Tipo de item: Monocristalino (tipo P), 182x91mm  
Número de elementos: 144 (6x24)  
Número de pneus por fotocélula: 10

Vidro: alta transparência, 3,2 mm, revestimento anti-reflexo

**CARACTERÍSTICAS DE DESEMPENHO**

Máx. tensão do sistema: 1000 V/1500 V CC  
Temperatura de trabalho: -40 °C a +85 °C  
Máx. corrente do fusível: 25 A  
Carga de neve, lado frontal: 5 400 Pa

Cabo de saída (plug incluído):

diâmetro: 4,0 mm<sup>2</sup>  
Comprimento: 300/400 mm (personalizável).  
Caixa de junção: IP68, 3 diodos shunt.  
Conector: compatível com MC4

Carga do vento, lado traseiro:

2 400 Pa  
Temperatura nominal de operação do quadro de junção: 45 ± 2 °C  
Nível de aplicação: Classe A

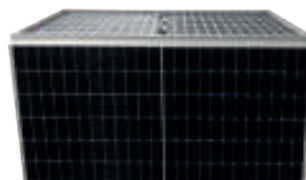
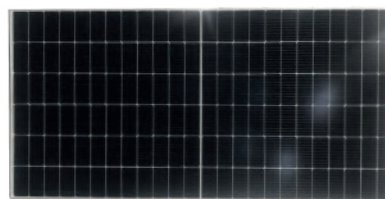

2279mm 1134mm 35mm

**ESPECIFICAÇÕES ELÉTRICAS**

(CONDIÇÕES DE TESTE PADRÃO)  
Potência máxima: 550W  
Fotovoltagem: 50,2 V  
Voltagem máxima: 42,4V  
Corrente de curto-circuito: 13,78 A  
Corrente máxima: 12,97 A  
Eficiência do módulo: 21,28%.

**DADOS ELÉTRICOS**

(TEMPERATURA DE OPERAÇÃO NORMAL DOS ELEMENTOS)  
Potência máxima: 409W  
Fotovoltagem: 47,1 V  
Voltagem máxima: 39,8V  
Corrente de curto-circuito: 11,13 A  
Corrente máxima: 10,29 A

Contacte-nos em:  
[solar@jbmcamp.com](mailto:solar@jbmcamp.com)



para cotações, relatórios, preços e informações técnicas



# CARRO ELÉTRICO



**Híbrido e elétrico**

## CABO DE CARREGAMENTO

<b>54053</b> 248,00€	<b>16A</b> <b>3.6 kW</b> <b>Tipo 1-2</b>	<b>Monofásico</b> Single-Phase
2.15 Kg	1	
<b>54054</b> 268,00€	<b>32A</b> <b>7.5 kW</b> <b>Tipo 1-2</b>	<b>Monofásico</b> Single-Phase
2.90 Kg	1	102
<b>54055</b> 220,00€	<b>16A</b> <b>3.6 kW</b> <b>Tipo 2-2</b>	<b>Monofásico</b> Single-Phase
2.15 Kg	1	102
<b>54056</b> 260,00€	<b>16A</b> <b>11 kW</b> <b>Tipo 2-2</b>	<b>Trifásico</b> Three-Phase
2.85 Kg	5	102
<b>54057</b> 248,00€	<b>32A</b> <b>7.5 kW</b> <b>Tipo 2-2</b>	<b>Monofásico</b> Single-Phase
2.95 Kg	5	102
<b>54058</b> 348,00€	<b>32A</b> <b>22 kW</b> <b>Tipo 2-2</b>	<b>Trifásico</b> Three-Phase
3.85 Kg	1	102



<b>IP 66</b>	<b>5m</b>	<b>-25°</b> <b>+55°</b>	<b>Tipo 1-2</b>	<b>IP 66</b>	<b>5m</b>	<b>-25°</b> <b>+55°</b>	<b>Tipo 2-2</b>
--------------	-----------	----------------------------	-----------------	--------------	-----------	----------------------------	-----------------

## ESTAÇÃO DE CARREGAMENTO

<b>54059</b> 428,00€	<b>16A</b> <b>3.68 kW</b> <b>Tipo 2</b>	
2.55 Kg	5	102
<b>IP 66</b>	<b>6m</b>	<b>-25°</b> <b>+55°</b>



## CARTÃO RFID

<b>15460</b> 5,00€	<b>16198</b> 5,00€
0.01 Kg	0.01 Kg
250	



## CARREGADOR DE REDE

<b>52600</b> 884,00€	<b>16A</b> <b>3.6 kW</b> <b>Tipo 2</b>	<b>Monofásico</b> Single-Phase
4.65 Kg	4	80
<b>52902</b> 970,00€	<b>32A</b> <b>7.5 kW</b> <b>Tipo 2</b>	<b>Monofásico</b> Single-Phase
4.90 Kg	4	40
<b>52903</b> 1.100,00€	<b>16A</b> <b>11 kW</b> <b>Tipo 2</b>	<b>Trifásico</b> Three-Phase
5.25 Kg	1	40
<b>54052</b> 1.100,00€	<b>32A</b> <b>22 kW</b> <b>Tipo 2</b>	<b>Trifásico</b> Three-Phase
5.60 Kg	1	80



## CARREGADOR DE REDE 22 KW, 32 A, PARA CARROS ELÉTRICOS (TRIFÁSICO)

<b>54265</b> 1.290,00€	<b>32A</b> <b>22 kW</b> <b>Tipo 2</b>	
5.35 Kg	1	120
<b>Trifásico</b> Three-Phase		



## MEDIDOR DE CORRENTE ELÉTRICA PARA CARREGADOR 54265

<b>16130</b> 290,00€
0.40 Kg
15

Com este acessório o carregador 54265 é capaz de regular a sua potência de carregamento calculando o total consumido pelos restantes aparelhos elétricos da instalação doméstica; evitando sobrecargas e cortes na rede.



## POSTE DE PLÁSTICO PARA CORRENTE ALTA TENSÃO

53940 13,20€

- Material: PVC.

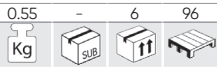

CORRENTE NÃO INCLUÍDA

- ✓ Para uma vedação simples, rápida e móvel de áreas interiores e exteriores com limitações.
- ✓ Suas cores contrastantes tornam a corrente altamente visível para restringir áreas de alta tensão.



**ESPECIAL  
SINALIZAÇÃO DE ALTA  
TENSÃO**



BASE INFLÁVEL

850mm



## ELO DE FECHAR

53942 0,50€

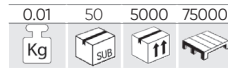

## CORRENTE DE PVC

53941 6,05€

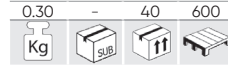

- Comprimento: 5m
- Link: 6mm
- Cor: Vermelho / Branco

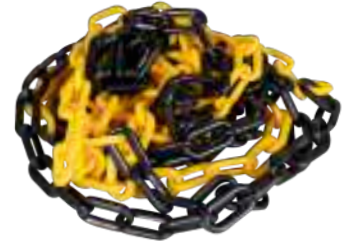

## FITA DE SINAL 200M

53987 9,50€

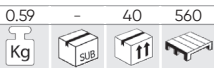

200M X 10cm



## PINÇA AMPERIMÉTRICA

52382 19,50€

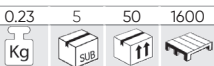

52952 74,00€



## MULTÍMETRO DIGITAL

50942 28,00€

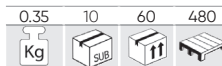

- Dígitos: 3 1/2.
- Medição: 2 000.
- Dados instantâneos.
- Autoapagado.
- Indicador de bateria.
- Baterias de 9 V.
- Sonda de temperatura.
- Temperatura de -40 °C a 1000 °C.

<b>V</b> AC	200mV, 2V, 20V, 200V, 1000V	<b>A</b> AC	20mA, 200mA, 20A
<b>V</b> DC	200mV, 2V, 20V, 200V, 750V	<b>A</b> DC	20mA, 200mA, 20A
<b>Ω</b>	200Ω, 2KΩ, 20KΩ, 200KΩ, 2MΩ, 20MΩ, 2000MΩ		
<b>F</b>	2nF, 20nF, 200nF, 2μF, 20μF, 200μF		



## ESTOJO DE FERRAMENTAS ISOLADAS 20 PEÇAS DE 3/8"

53154 462,00€

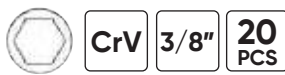

## ESTOJO DE FERRAMENTAS ISOLADAS 20 PEÇAS DE 3/8"

54091 441,00€



72	72	3/8"
ALICATE UNIVERSAL	x1	

x1	125mm	x4	PHILIPS VDE 1x80mm, 2x100mm	x1	200mm
x1	ALICATE CORTE DIAGONAL	x1	200mm	x1	200mm



## CONJUNTO DE 50 CHAVES ISOLADAS ATÉ 1.000V

**52521** 125,00€

1.43 - 6 216

Kg SUB ITT

**CrV** **50 PCS** **AC 1000V IEC 60900:2004**

x9	T6x100 T8x100 T9x100 T10x100 T15x100 T20x100 T25x100 T27x100 T30x100	x7	0.4x2.0x100 0.4x2.5x100 0.5x3.0x100 0.6x3.5x100 0.8x4.0x100 1.0x5.5x100 1.2x6.5x100	x5	H2.5x100 H3.0x100 H4.0x100 H5.0x100 H6.0x100
	x4		4x100 6x100 8x100 10x100		TRI 1x100 TRI 2x100 TRI 3x100 TRI 4x100
x4		x4	TORO 4x100 TORO 6x100 TORO 8x100 TORO 10x100	x3	PZ0x100 PZ1x100 PZ2x100
x2	6.3x89 8.1x89	x2	R1x100 R2x100	x3	M4x4.0x100 M5x5x100 M6x5.0x100
				x1	89



Voltage Tester: 3.0x70 +  
Torx: 31x105

## CONJUNTO DE PONTAS E CHAVES ISOLADAS ATÉ 1000V

**52009** 36,00€

0.34 10 50 1200

Kg SUB ITT

**AC 1000V IEC 60900:2004**

x2	PH1x100, PH2x100
x5	0.4x2.5x100, 0.8x4.0x100, 1.0x5.5x100, 1.2x6.5x100



## CONJUNTO DE 7 CHAVES ISOLADAS ATÉ 1.000V

**52519** 25,50€

0.14 5 10 840

Kg SUB ITT

**AC 1000V IEC 60900:2004** **CrV**

x2	PH00x50, PH0x50mm
x5	SL1.5x0.23x50, SL1.8x0.30x50, SL2.0x0.40x50, SL2.5x0.40x50 SL3.0x0.50x50mm

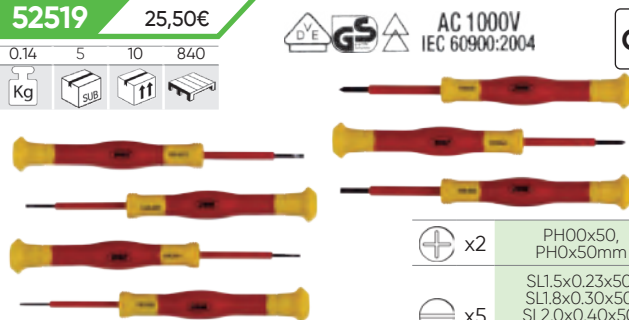

## CHAVE DE FENDA ISOLADA EVA - ACABAMENTO DE CARBONO

**15162** 30,20€

0.65 - 10 240

Kg SUB ITT

**AC 1000V IEC 60900:2004**

x2	PH 0x75mm PH 1x80mm PH 2x100mm	<b>8 PCS</b>
x5	SL 3x75mm SL 4x100mm SL 5.5x125mm SL 6.5x150mm	
	140mm SL 0.5 x 3.0 mm 1000V	<b>VDE</b>

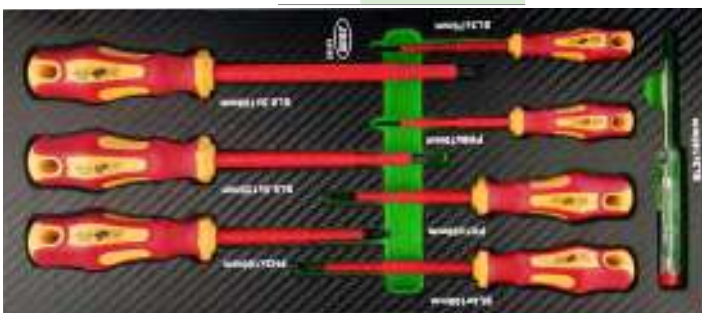

## FACA ISOLADA

**RETA**

**53164** 16,50€

0.10 6 36 1152

Kg SUB ITT

**AC 1000V IEC 60900** **CrV**

180mm  
50mm

**Certificate EN60900**



**CURVADA**

**53165** 19,60€

0.10 6 36 1152

Kg SUB ITT



## MEDIDOR DE RESISTÊNCIA DE ISOLAMENTO

**54114** 248,00€

1.48 - 10 100

Kg SUB ITT

Este instrumento auxilia na medição do isolamento elétrico a uma determinada voltagem (250 V, 500 V ou 1000 V). É uma ferramenta indispensável para avaliar a integridade de um circuito elétrico, especialmente necessária para verificar que os componentes e a instalação em carros elétricos estão completamente isolados da carroceria. Em instalações industriais, é esta a ferramenta que permite fazer inspeções periódicas à resistência do isolamento. Medições necessárias para a norma DIN VDE 0105-100 (VDE 0105-100: 2009-10).

Categoria de instalação:	2	Voltagem de amostragem:	2,5 vezes por segundo
Categoria de medição:	CAT III	Ajuste zero:	Ajuste automático
Altitude:	Até 2000 metros	Temperatura de funcionamento:	0° - 40°C (32°F - 104°F), humidade relativa inferior a 80%
Display:	LCD com visor duplo	Temperatura de armazenamento:	-10°C - 60°C (14°F - 140°F), humidade relativa inferior a 70%
Tensão AC:	0 - 750V	Fonte de potência:	DC9V (pilhas tamanho "AA" 6x1,5V)
Tensão DC:	0 - 1000V	Dimensões (comprimento x largura x altura):	200 x 92 x 50mm
Resistência:	0 - 200Ω / 200 - 2000 Ω		
Resistência de isolamento:	0 - 200MΩ / 200 - 2000 MΩ		



# CARRO DE 7 GAVETAS ESPECIAL VDE

<b>54233</b>	1.856,00€	<b>54234</b>	1.856,00€	<b>54235</b>	1.856,00€	<b>54236</b>	1.856,00€
67.70	-	1	4	67.70	-	1	4
Kg	Sub	ff	ff	Kg	Sub	ff	ff

Corro especialmente elaborado para cobrir todas as necessidades básicas derivadas da manutenção e reparação de veículos híbridos e elétricos, bem como para trabalhos de alta tensão.

**TERMÓMETRO LÁSER**  
-50°C A 550°C

52162 38,00€



**POSTE DE PLÁSTICO PARA CORRENTE - AMARELO / PRETO**

53940 13,20€



x4

**CORRENTE DE PVC - 5M - AMARELO/ PRETO**

53941 6,05€



x4

**ELO DE FECHAR PRETO**

53942 0,50€



x8

**LUVAS ISOLANTES PARA TRABALHOS SOB TENSÃO T.9**

54130 58,00€



**GANCHO DE RESGATE ISOLADO - 45KV**

54241 120,00€



**MÓDULO DE FERRAMENTAS VDE COM ISOLAMENTO DE EVA (ETILENO ACETATO DE VINILA)**

54093 441,00€



**MEDIDOR DE RESISTÊNCIA DE ISOLAMENTO**

54114 248,00€



**TAPETE ISOLANTE CLASSE 0**

54129 110,00€

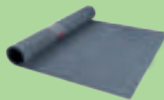

## LUVAS ISOLANTES PARA TRABALHOS SOB TENSÃO

<b>54130</b>	58,00€	<b>T.9</b>	<b>54131</b>	58,00€	<b>T.10</b>
0.35	-	1	100		
Kg	Sub	ff	ff		

IEC ELECTRICAL SAFETY GLOVES 60903-2014 CLASS 0
   
 1000V AC - 1500V DC
   
**AZC**
  
 360mm
   
**LATEX**
  
 CLASS 0 / CLASS 0
   
 cat.3

## POSTE DE SALVAMENTO ISOLADO - 45KV

<b>54241</b>	120,00€		
1.10	-	1	50
Kg	Sub	ff	ff

Ø 3cm | 165cm | 37cm

IEC ELECTRICAL SAFETY MATTING 60903-2014 CLASS 0

## TAPETE ISOLANTE CLASSE 0

<b>54129</b>	110,00€		
2.10	-	5	200
Kg	Sub	ff	ff

0,6x1m | 2mm

1,8KG
   
 IEC ELECTRICAL SAFETY MATTING 60903-2014 CLASS 0
   
 1000V AC - 1500V DC

CLASS 0 / CLASS 0
   
 SLIP RESISTANT / ANTI-DESLIZANTE
   
 ROLLS / ENROLLABLE
   
 RECYCLABLE / RECICLABLE
   
 OIL RESISTANT / RESISTENTE A MANCHA

## PROTEÇÃO FACIAL ISOLANTE PARA TRABALHOS SOB TENSÃO

<b>54132</b>	190,00€		
0.70	-	1	62
Kg	Sub	ff	ff

EN 166 : 2001
   
 EN 170 : 2002
   
 ANSI Z87.1

Anti-vaio / Anti fog
   
 Anti-ralladuras / Scratching Proof

Class 1





## **ACESSÓRIOS**

- 292 CARRETEIS
- 293 ESCADAS
- 294 CARROS
- 295 ORGANIZADORES
- 296 PARA CARRO
- 298 KITS DE EMERGÊNCIA /  
KITS DE PRIMEIROS SOCORROS
- 305 SENSORES DE ESTACIONAMENTO
- 306 TAPETES
- 307 ESCOVAS LIMPA-VIDROS
- 308 CONTRAPESOS
- 309 VÁLVULAS TPMS
- 310 PARA PNEUS
- 314 FOLE DE TURISMO UNIVERSAL /  
FERRAMENTA PNEUMÁTICA PARA MONTAGEM DE FOLE

# CARRETEL DE MANGUEIRA DE ÁGUA

**53872** 118,00€

7,50	-	1	21
Kg	Sub	ft	ft

- Comprimento: 15 + 1,5 m
- Conexão 3/4"
- Diâmetro da mangueira: 1/2"
- Diâmetro interno: 11,5 mm
- Diâmetro externo: 15,8 mm
- Pressão de trabalho 120 psi/8 bar
- Enrolamento de mangueira automático
- Material da mangueira: PVC

15m + 1,5m | 15,8mm / 11,5mm | 120PSI 8BAR | 3/4" PVC



### CONECTOR DE MANGUEIRA 1/2"

<b>15153</b>	2,50€
0,05	- 50 -
Kg	Sub ft ft

### CONECTOR

<b>15154</b>	7,50€
0,05	- 50 -
Kg	Sub ft ft

# CARRETEL DE MANGUEIRA DE AR

VEJA A PAG. 146

**53582** 179,00€

10,85	-	1	14
Kg	Sub	ft	ft

**22M**

300 PSI 20 BAR | 3/8"



**53583** 170,00€

10,75	-	1	14
Kg	Sub	ft	ft

**53532** 119,00€

6,80	-	2	30
Kg	Sub	ft	ft

**13M**



**53581** 115,00€

6,70	-	2	30
Kg	Sub	ft	ft

**53881** 79,00€

4,50	-	4	48
Kg	Sub	ft	ft

**11 M**



**53882** 79,00€

4,50	-	4	48
Kg	Sub	ft	ft

**11 M**

# CARRETEL ELÉCTRICO

**53585** 168,00€

8,35	-	2	34
Kg	Sub	ft	ft

230V | 1000W / 1000W | 1400PM-F 100L Smart | IP 44

**21M**



**53586** 158,00€

8,35	-	2	30
Kg	Sub	ft	ft

**53526** 168,00€

5,15	-	4	48
Kg	Sub	ft	ft

**12M**



**53584** 119,00€

5,10	-	4	48
Kg	Sub	ft	ft

# CARRETEL DE MANGUEIRA PARA ÓLEO

**50797** 490,00€

26,60	-	1	14
Kg	Sub	ft	ft

**160 BAR**

À base de óleo / bobina  
Comprimento da mangueira:  
15 + 1 m  
Máx. pressão de trabalho: 2.450  
psi  
Entrada de ar: 1/2" BSPT  
(rosca cônica padrão  
britânico)  
Saída de ar: 1/2", rosca cônica  
padrão britânico  
Material: aço



ACESSÓRIOS DE OFICINA



## ESCADA MULTIFUNÇÕES

**54176** 188,00€



CONTÉM

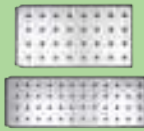

CONJUNTO DE 2 PLATAFORMAS

**15866** 32,00€



## ESCADA TELESCÓPICA

**51982** 120,00€



↑ 2.000mm  
↓ 730mm 6 degraus

**51984** 190,00€



↑ 3.800mm  
↓ 1.020mm 12 degraus

**51983** 180,00€



↑ 3.200mm  
↓ 930mm 10 degraus

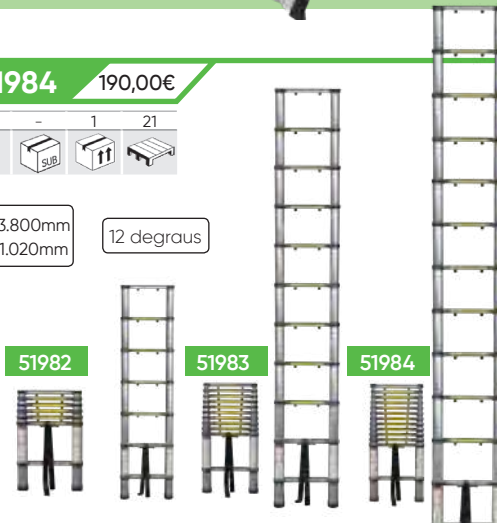

CUMPRE COM: EN 131

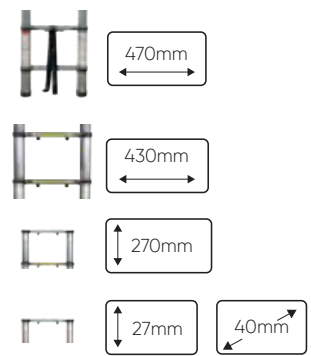

## ESCADA TELESCÓPICA EM "V" DOBRÁVEL

**52149** 230,00€



- Escada dobrável e leve.
- Sistema de dobrado mediante bloqueio.
- Fabricada em alumínio e plástico.

- Altura fechada: 835mm.
- Altura aberta: 3800mm.
- Altuar dobrada: 1900mm.

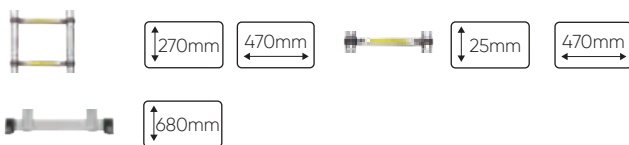

CUMPRE COM: EN 131



## ESCADOTE DE ALUMÍNIO

**50517** 129,00€



- 4 DEGRAUS
- Altura total: 1,30m.
- Altura máx. trabalho: 0,79m.



**50518** 169,00€



- 6 DEGRAUS
- Altura total: 1,91m.
- Altura máx. trabalho: 1,31m.

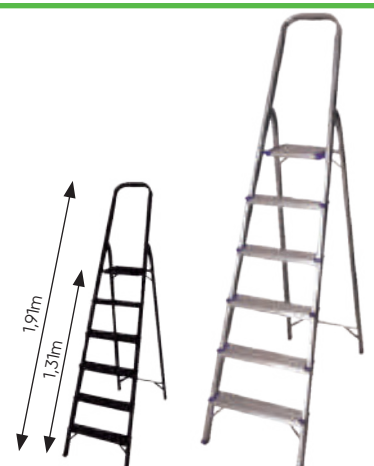

IVA não incluído

## BALANÇA DE PRECISÃO

54246 104,00€

Inox  
304

2.27 - 10 400  
Kg SUB

0°C 40°C 220V G/LB CT/OZ

5,0kg PRECISÃO 0,1g CONVERSÃO DE UNIDADES

BATERIA ULTRA DURACÃO BATERIA ULTRA DURACÃO



54247 99,00€

2.40 - 8 400  
Kg SUB

0°C 40°C 220V G/LB CT/OZ

2,0kg PRECISÃO 0,01g CONVERSÃO DE UNIDADES

PROTECTOR CONVERSÃO DE UNIDADES BATERIA ULTRA DURACÃO



## CARRINHO DE MÃO

52201 66,00€

ABERTO

6.18 - 4 36  
Kg SUB

1.060mm

380mm

FEXADO

700mm 400mm 200mm

400mm

DOBRÁVEL E  
EXTENSÍVEL



## CARRINHO DE MÃO 2 RODAS BASICO DE AÇO

52202 88,00€

90Kg

9.35 - 1 12  
Kg SUB

200Kg

110mm 450mm 500mm



RODA DE PLÁSTICO 3.00-4 (260x85) PARA REF. 52202 - 52661

12055 20,00€ 1.11 10 160  
Kg SUB



## CARRINHO PLATAFORMA DE AÇO

52200 88,00€

150Kg

7.80 - 1 32  
Kg SUB

ABERTO

840mm 725mm 475mm

DOBRAGEM



FEXADO 230mm 725mm 475mm



2 RODAS  
ROTATIVAS



## CAIXA 24+2 COMPARTIMENTOS

50957 22,00€

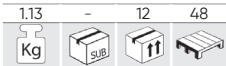
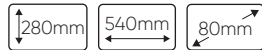

- 24 compartimentos de 8x5,5 cm.
- 2 compartimentos de 15x7,5 cm.
- Abatível de 26 a 5 separações.

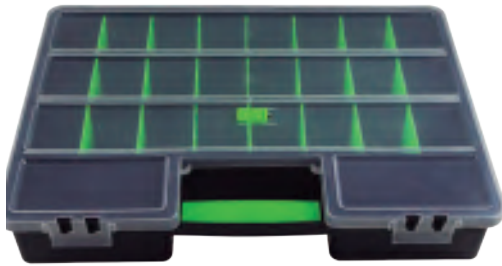

## CAIXA 18+1 COMPARTIMENTOS

50959 12,00€

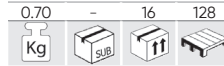

- 18 compartimentos de 6x7 cm.
- 1 compartimento de 35x7 cm.
- Abatível 19 a 4 separações.

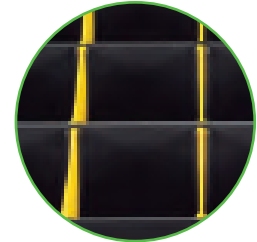

## ORGANIZADOR DE 5 COMPARTIMENTOS

51051 34,80€

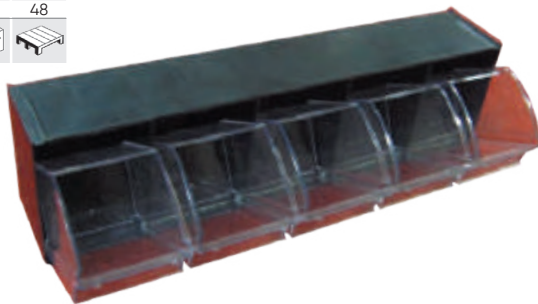
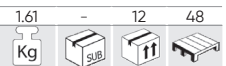

CAIXAS  
INSEPARÁVEIS

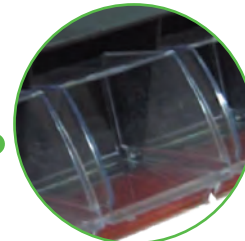

## KIT 8 CAIXAS DE ENCAIXE COM GUÍA

50960 18,30€



GAVETAS



GUÍA

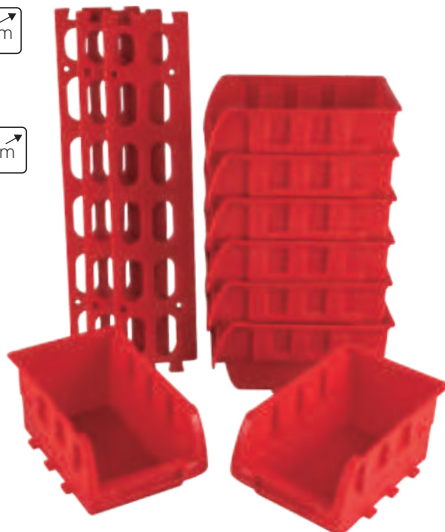

## ESTANTERIA COM 47 COMPARTIMENTOS

51050 285,00€

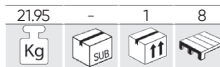

COMPARTIMENTOS  
GRANDES  
Total: 15  
Medidas: 24x14.5x13 cm  
Medidas da estanteria: 84x14x24 cm  
Total estantes: 3

COMPARTIMENTOS  
PEQUENOS  
Total: 32  
Medidas: 16x10x7.5 cm  
Medidas da estanteria: 84x16x8 cm  
Total estantes: 4

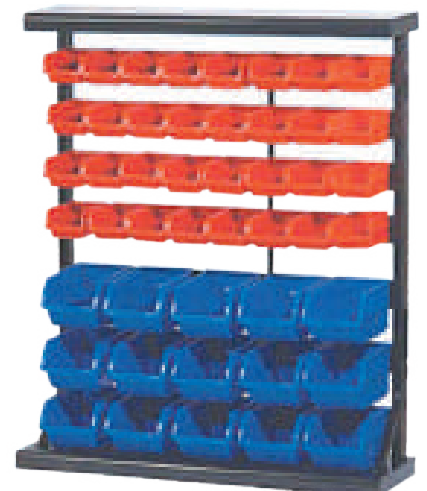

## TENDA DE TECTO RÍGIDO

54180 2.400,00€

100.00	-	1	-
Kg	SUB	11	11

REF.	DESCRIÇÃO	Kg	SUB	11	€
15905	Conjunto de parafusos e pernos para tenda	0,15	10	100	16,50€
15906	Conjunto de placas de instalação para tenda	0,1	10	100	28,50€
15907	Luz interior de tenda	0,3	10	100	12,00€
15908	Suportes de janela e porta para tenda	0,95	10	100	14,50€
15909	Barra de suporte para tenda				21,50€
15910	Cortina de entrada para tenda				16,50€

- Material do teto: fibra de vidro branca. mantém o interior da tenda protegida da temperatura exterior.
- Tecido: poliéster 600d ripstop, resistente à água, mofo e UV.
- Colchão de espuma de alta densidade com cobertura lavável; 60mm de espessura.
- Escada telescópica de alumínio
- Mini-luz no interior
- Inclui acessórios de instalação
- Tamanho interior: 120x208cm



## TOLDO PARA CARRO

54185 390,00€

20.00	-	1	-
Kg	SUB	11	11

2000mm 2500mm

O toldo para veículo é um acessório de carro que ajuda a proteger o veículo do sol, bem como a proteger o seu carro ou camião dos fenómenos meteorológicos.

- Contém:
- Toldo de carro (1)
- Clavo (4)
- Corda (2)
- 8 x 20mm parafuso de aço inoxidável (4)
- Faixa L (2)
- Parafuso quadrado de 8 x 20mm (2)
- Parafuso quadrado de 20mm (2)
- Chave inglesa (1)



REF.	DESCRIÇÃO	Kg	SUB	11	€
15911	suportes para toldo para carro (2 peças)	0,15	10	100	30,50€
15912	conjunto de parafusos e pernos para toldo para carro	0,1	10	100	35,50€
15913	estacas para toldo para carro (2 peças)	0,3	10	100	7,50€
15914	saco e 2 cordas para toldo para carro	0,95	10	100	7,50€



# CADEIRINHA DE CARRO

54196

133,00€

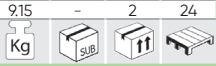

E24

ECE R44/04

Grupo 1 (9-18kg) voltada para o sentido da marcha, com sistema de arnês e equipada com cinto de segurança de 3 pontos.

## GRUPO 0+ / 1/2

Grupo 0+ (0-13kg) voltada para o sentido inverso à marcha, com sistema de arnês na posição mais reclinada.

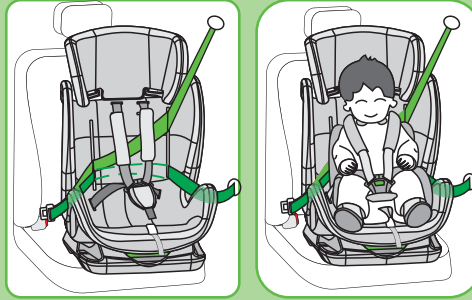
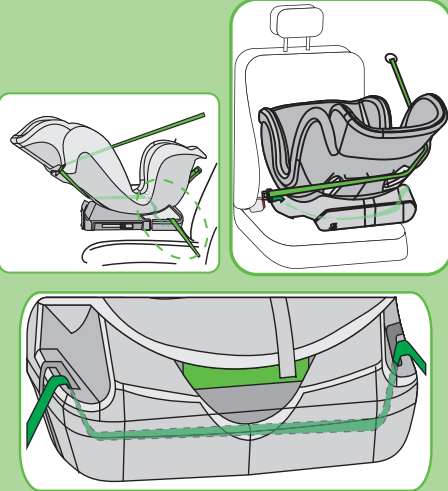

Grupo 2 (15-25kg) voltada para o sentido da marcha, sem sistema de arnês e equipada com cinto de segurança de 3 pontos

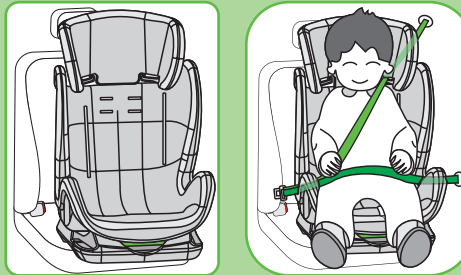

-6 posições de apoio de cabeça  
-3 posições de almofada de ombro  
-4 posições de reclinção  
Capas de tecido removíveis e laváveis

54197

118,00€

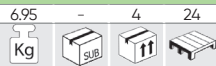

E24

ECE R44/04

## GRUPO 1/2/3

Grupo 1 (9-18kg) voltada para o sentido da marcha, com sistema de arnês e equipada com cinto de segurança de 3 pontos

Grupo 2/3 (15-36kg) voltada para o sentido da marcha, sem sistema de arnês mas equipada com cinto de segurança de 3 pontos



Capas de tecido removíveis e laváveis

# ALMOFADA COM SISTEMA DE ALARME ANTI-ABANDONO

54102

60,00€



Sistema anti-abandono com sensores integrados que colocados na cadeira auto, permitem detetar a presença da criança a bordo. Sensores de pressão conectados a um aplicativo instalado no telemóvel detectam a presença da criança na cadeirinha e enviam um sinal de alarme caso os pais deixem a criança no carro. O aplicativo está disponível gratuitamente para sistemas Android e iOS, conecta-se a sensores de pressão via Bluetooth e oferece a possibilidade de registar mais de um contato de emergência.

### ESPECIFICAÇÕES TÉCNICAS

Dimensões: 220*300*13.5mm
Peso: 100g
Banda de frequência: 24-2485 GHz
Potência de transmissão: 2,51 mw
Alimentação: bateria Cr 3032 (substituível)
Temperatura de operação: -10 °C a +60 °C
Tecido: Neoprene, Spandex, SBR
Compatível com IOS e Android

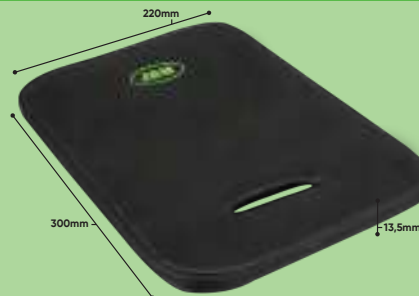

## TECLADO DE ALARME PARA ASSENTO INFANTIL PARA CARRO

15671

20,50€



# KIT EMERGÊNCIA

VER O PREÇO PARA AS QUANTIDADES  
DESENHO PERSONALIZÁVEL, PEDE COTAÇÃO  
SERIGRAFIA E FOTOLITO NÃO INCLUI



## KIT DE EMERGÊNCIA EM CAIXA DE PLÁSTICO

**53540** 23,00€

2,10	-	9	144
Kg		Sub	Paq

LANTERNA DE DINAMO



COLETE AMARELO



2 TRIÂNGULOS DE SINALIZAÇÃO



Configurável a partir de **50 unidades**.

LUVAS DE ALGODÃO COM PALMA REFORÇADA DE PONTOS DE BORRACHA



CAIXA DE PLÁSTICO RÍGIDA



\* Duplo triângulo, obrigatório só em Espanha.

## ESTOJO CON RIBETE

550 x 90 x 130mm

**51692** 3,25€

3,25€

**51694** 3,55€

3,55€

**51693** 3,55€

3,55€

**51696** 3,55€

3,55€

0,11	-	100	1200
Kg		Sub	Paq



VELCRO

## ESTOJO MINI PARA KIT DE EMERGÊNCIA 550 x 150mm

**53624** 2,50€

2,50€

**53621** 2,50€

2,50€

**53623** 2,50€

2,50€

**53622** 2,50€

2,50€

0,05	-	100	3200
Kg		Sub	Paq



VELCRO

## ESTOJO COM 1 COMPARTIMENTO ROJO 565 x 100 x 130mm

**51681** 4,50€

4,50€

0,17	-	100	700
Kg		Sub	Paq



VELCRO

- Em tela "red" e com feixo de velcro.

## ESTOJO PRETO PARA KIT DE EMERGÊNCIA EN PVC 570 x 110 x 65mm

**51691** 2,40€

2,40€

0,18	-	100	1600
Kg		Sub	Paq

VELCRO

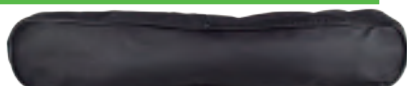

## SACO PRETO PARA KIT DE EMERGÊNCIA COM RIBETE

**11328** 4,00€

4,00€

0,12	-	100	1200
Kg		Sub	Paq



## ESTOJO VERDE DE NYLON ESPECIAL 470 x 65 x 140mm

**10945** 2,30€

2,30€

0,12	-	100	1600
Kg		Sub	Paq

VELCRO



## ESTOJO COM 6 COMPARTIMENTOS E DIVISÃO 570 x 100 x 130mm

**51680** 2,40€

2,40€

0,28	-	100	800
Kg		Sub	Paq

VELCRO



- Em tela "red" e com feixo de velcro.  
- Divisao central com 6 compartimentos.



## KIT EMERGÊNCIA

COLOQUE SEU LOGO

x1	<b>53177</b> 11,90€	x2	<b>53181</b> 11,90€
	<b>53178</b> 12,20€		<b>53182</b> 12,20€
	<b>53179</b> 12,20€		<b>53183</b> 12,70€
	<b>53180</b> 12,20€		<b>53184</b> 12,20€

\* Duplo triângulo, obrigatório só em Espanha.

## KIT EMERGÊNCIA ESTOJO PVC

COLOQUE SEU LOGO

x1	<b>53185</b> 13,20€	x2	<b>53186</b> 13,20€
----	---------------------	----	---------------------

\* Duplo triângulo, obrigatório só em Espanha.

## KIT EMERGÊNCIA

COLOQUE SEU LOGO

<b>53087</b> 11,20€	<b>53089</b> 11,50€
<b>53088</b> 11,50€	<b>53090</b> 11,50€

## KIT EMERGÊNCIA

COLOQUE SEU LOGO

<b>53091</b> 10,20€	<b>53093</b> 10,30€
<b>53092</b> 10,30€	<b>53094</b> 10,20€

## KIT EMERGÊNCIA

H1 (12V) H4 (12V) H7 (12V)

\* Duplo triângulo, obrigatório só em Espanha.

MK H1		MK H4	
<b>52768</b> 13,80€	<b>52769</b> 14,50€		
<b>52772</b> 13,90€	<b>52773</b> 14,60€		
<b>52776</b> 13,80€	<b>52777</b> 15,50€		
<b>52780</b> 13,90€	<b>52781</b> 14,60€		
MK H7		MK H7+H1	
<b>52770</b> 23,00€	<b>52771</b> 23,40€		
<b>52774</b> 14,80€	<b>52775</b> 15,20€		
<b>52778</b> 14,60€	<b>52779</b> 17,10€		
<b>52782</b> 14,80€	<b>52783</b> 15,20€		

## TRIÂNGULO DE SINALIZAÇÃO HOMOLOGADO

**53778** 4,50€

0,35	-	40	1440
Kg	Sub	ff	ff

x1 



CUMPRE COM: E4 27R-032736

**52795** 5,80€

0,60	1	20	980
Kg	Sub	ff	ff

x1 



CUMPRE COM: E4 27R-032738

## COLETE REFLECTOR HOMOLOGADO

**51817** 4,50€

0,13	-	100	2600
Kg	Sub	ff	ff

Banda marcada



CUMPRE COM: EN ISO20471:2013 +A1:2016

**50654** 4,00€

0,13	-	100	2600
Kg	Sub	ff	ff

Banda marcada



CUMPRE COM: EN ISO20471:2013 +A1:2016

**50966** 4,00€

0,12	-	100	2600
Kg	Sub	ff	ff

Banda marcada



CUMPRE COM: EN ISO20471:2013 +A1:2016

## CAPA IMPERMEÁVEL

**50525** 1,00€

0,05	-	250	6250
Kg	Sub	ff	ff



## PISTOLA PLÁSTICA PARA LATA DE SPRAY

**52493** 4,50€

0,06	-	180	2160
Kg	Sub	ff	ff

- Acessório útil para utilizar com a maioria de sprays do mercado.



## SPRAY TAPA FUROS

**51814** 8,00€

0,30	-	12	1260
Kg	Sub	ff	ff

- Para corrigir o pneu furado em menos de um minuto sem mudar a roda ou desmontar.

300ml



## ESPÁTULA TIRA GELO

**51697** 0,80€

0,03	-	300	6000
Kg	Sub	ff	ff



## GUARDA-CHUVA DOBRÁVEL

**50526** 4,80€

0,20	-	100	2000
Kg	Sub	ff	ff



## TIJERAS MINI DE 9 cm

**51925** 1,00€

0,01	100	1000	40000
Kg	Sub	ff	ff



## MARTELO QUEBRA-VIDROS COM SUPORTE E CORTE DE CINTO DE SEGURANÇA

**52259** 3,75€

0,15	50	100	2400
Kg	Sub	ff	ff

135mm  
20mm  
75mm  
Ø 160mm



## SOPORTE DE CELULAR PARA AUTO

**53443** 7,55€

0,05	-	100	5000
Kg	Sub	ff	ff



ENGATE

## ISOLAMENTO TÉRMICO PARA KITS DE PRIMEIROS SOCORROS

**15396** 2,04€

0,01	-	200	-
Kg	Sub	ff	ff



CE



## CINTO DE SEGURANÇA PARA AUTOCARROS

CINTO DE 2 PONTOS

CUMPRE COM:  
E4-16R-0436213

**50644** 11,60€

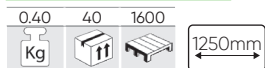

CINTO DE 2 PONTOS  
ENROLÁVEL

CUMPRE COM:  
E4-16R-0436232

**50717** 21,90€

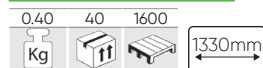

CINTO DE 3 PONTOS EN-  
ROLÁVEL

CUMPRE COM: E4-16R-0436232

**51266** 28,00€



## SACO DE PVC COM ZÍPER/ FECHO

**14918** 0,23€

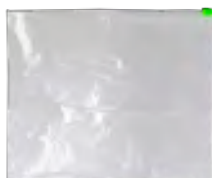

**14919** 0,45€



## SET ORGANIZADOR DE MALETERO MULTIFUNCCIONAL

**52618** 29,00€



Composto per 4 peças:  
- Cofre flexível com tampa 37l (300mm x 490mm).  
- Bidon circular 180mm de Ø. com tampa (230mm altura).  
- Suporte porta objectos (90mm altura x 260mm amplo).  
- Bandeja rígida (175mm altura x 300mm largj).



## JOGO DE 3 CAMURÇAS DE MICROFIBRAS

**53221** 4,75€

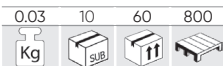

- Conjunto de 3 camurças em microfibra, material 100% poliéster de alta qualidade.  
- Ideal para limpeza geral (espanar, desengordurar, polir ...).  
- Grande capacidade de absorção de líquidos.  
- Sem deixar fios residuais.



IDEAL PARA  
LIMPEZA GERAL  
DE QUALQUER  
VEÍCULO



VÁRIOS  
APLICATIVOS

GRANDE CAPACIDADE  
DE ABSORÇÃO DE  
LÍQUIDOS



## LUVAS DE NITRIL, VINIL, COURO, ALGODÃO ...

VEJA A PAG. 306



IVA não incluído

**JBM**

[www.jbmcamp.com](http://www.jbmcamp.com)

301

## FITA REFLEXIVA DE MARCAÇÃO PARA VEÍCULOS DE MERCADORIAS

**51935** 135,00€

1.04	-	10	280
Kg	Sub	11	11

**51936** 135,00€

1.04	-	10	140
Kg	Sub	11	11

50mm 50mm

**51937** 135,00€

1.02	-	10	280
Kg	Sub	11	11



- Aplicação a partir de 10 de julho de 2011 segundo modificação do Regulamento General de Vehiculos, aprovado pelo Real Decreto 2822/1998, de 23 de Dez. 2010.  
- Disponível em amarelo, vermelho e branco.



**HOMOLOGAÇÃO:**  
REGLAMENTO CEPE/ONU 104R

## LANTERNA DE DINAMO DE 2 LEDS

**51573** 2,50€

0.07	12	96	3456
Kg	Sub	11	11



APRESENTAÇÃO CAIXA INDIVIDUAL

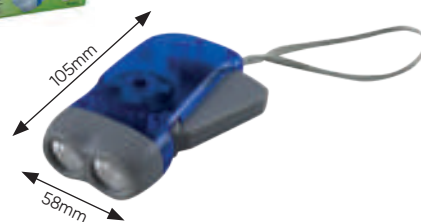

## CHAPA DE SINALIZAÇÃO V-20 "CARGA SUPERDIMENSIONADA"

- Placa para cargas salientes da parte traseira de qualquer veículo: caminhão / furgão / veículo turístico / ...  
- Com aprovação V20.

- Sinalização obrigatória em toda a Europa para transporte seguro.  
- Dimensões: 500x500mm.

**53636** 22,00€

0.45	5	25	750
Kg	Sub	11	11

FEITO DE POLIPROPILENO PARA UMA MAIOR FLEXIBILIDADE

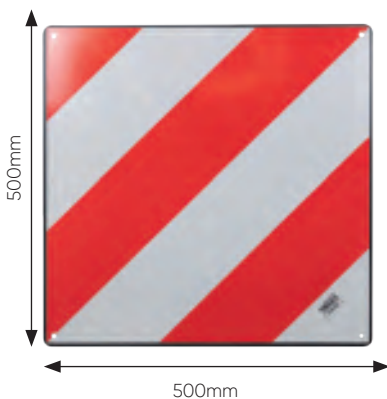

**53507** 24,00€

0.75	5	25	800
Kg	Sub	11	11

FRENTE EM POLIMETILMETACRILATO (PMMA) E TRASEIRA EM ALUMÍNIO

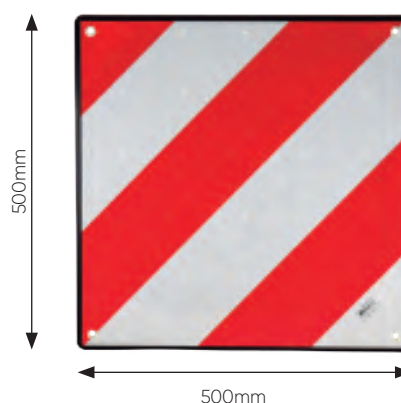

## CALÇO DE RODA

**53561** 28,00€

1.65	-	4	72
Kg	Sub	11	11



- Amarelo intenso para detectar visualmente fácil e rapidamente quando está sendo usado.

- **Peso leve:** fácil de transportar e manusear.

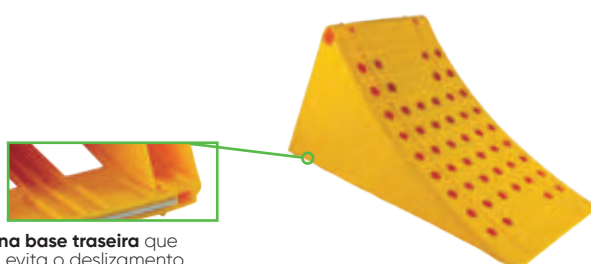
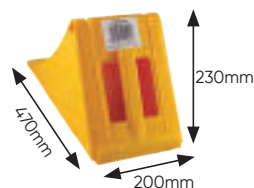

Com uma **tira de aço na base traseira** que **melhora sua fixação** e evita o deslizamento quando há gelo ou areia no pavimento.



SUPORTE DE CALÇO DE RODA

**14118** 26,00€

1.25	4	80
Kg	11	11

## CALÇOS DE RODA

**53508** 14,00€

0.35	4	24	288
Kg	Sub	11	11

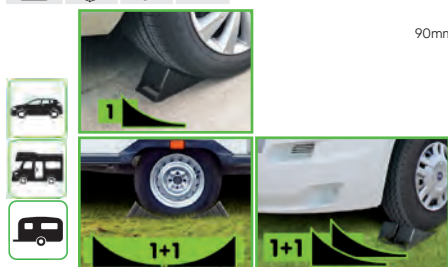



## BOLSA DE PRIMEIROS SOCORROS - DIN13164: 2022

54042 13,00€

Um kit de primeiros socorros compacto, ideal para carro e transporte. Fornecido numa bolsa com zíper e velcro na parte traseira.

0,40	-	10	600
Kg	Sub	ff	

### Equipamento:

- Fita adesiva DIN13019-A 5x2,5
- 1 conjunto de 14 peças contendo:
  - 4 fitas adesivas DIN 13019-E 10x6
  - 2 adesivos elásticos para os dedos 4x7 cm
  - 2 adesivos elásticos para os dedos 12x2 cm
  - 2 tiras de fita adesiva à prova d'água 1,9x7,2 cm
  - 4 tiras de fita adesivas à prova d'água 2,5x7,2 cm
- 1 bandagem estéril DIN 13151-K 6x8 cm
- 2 bandagens estéreis DIN 13151-M 8x10 cm
- 1 bandagem estéril DIN 13151-G 10x12 cm
- 1 bandagem de primeiros socorros DIN 13152-BR 60x40 cm
- 1 bandagem de primeiros socorros DIN 13152-A 60x80 cm
- 2 bandagens estéreis DIN 61634FB6 6 cm x 400 cm
- 3 bandagens estéreis DIN 61634FB6 8 cm x 400 cm
- 1 manta de resgate 160x210 cm
- 6 compressas estéreis para feridas 10x10 cm
- 2 bandagens triangulares DIN 13168-D
- 1 tesoura DIN 58279-A145 145 cm
- 4 luvas descartáveis DIN EN 455-1
- 2 lenços umedecidos para limpar pele
- 1 lista de conteúdos
- 1 guia de primeiros socorros



## BOLSA DE PRIMEIROS SOCORROS DIN13157: 2021

54072 38,50€

Este kit de montagem em parede inclui as âncoras necessárias para pendurar na parede.

1,55	-	10	120
Kg	Sub	ff	

### Contém:

- 1 gesso adesivo 5 x 25 - DIN13019-A
- 1 conjunto de bandagens adesivas 10 x 6 cm (8 unid.) - DIN13019-E
- 6 remendos de dedo 4 x 6,5 cm
- 6 remendos de dedo 120 x 20 mm
- 6 remendos de dedo 7,2 x 19 cm
- 12 remendos de dedo 25 x 72 mm
- 1 conjunto de bandagens de primeiros socorros, compressa estéril 6 x 8 cm - DIN13151-K
- 3 conjuntos de bandagens de primeiros socorros, compressa estéril 8 x 10 cm - DIN13151-M
- 1 conjunto de ataduras de primeiros socorros, compressa estéril 10 x 12 cm - DIN13151-G
- 1 compressa estéril (curativo de tratamento de queimadura) 60 x 80 cm - DIN13152-A
- 3 curativos esterilizados (compressas) 100 x 100 mm, 2 unidades / bolsa - DIN58953-2
- 2 tapa-olhos - 55 mm x 75 mm 1,5 g

- 2 bandagens elásticas de acordo com os requisitos da norma (gaze), 6 cm por 400 cm - DIN61634 FB6
- 2 bandagens elásticas de acordo com os requisitos da norma (gaze), 8 cm por 400 cm - DIN61634 FB8
- 2 bandagens triangulares 96x96x136 cm - DIN13168-D
- 1 tesoura de metal 190 mm - DIN58279-B190
- 2 sacos de plástico para lixo, 300 x 400 mm, 45 microns
- 5 materiais não tecidos 20 x 30 cm, min. 15 g/H9m2
- 1 luvas descartáveis de PVC L-AQL1.5 (conjunto de 4) - DIN EN 455-1
- 1 livreto de informações

- 1 compressa fria para tratamento de emergência, min. 200 cm<sup>2</sup>
- 1 manta de primeiros socorros, 160 x 210 cm, 12 microns



## BOLSA DE PRIMEIROS SOCORROS

51246 6,40€

0,20	-	50	800
Kg	Sub	ff	

- 1 Folha de primeiros socorros.
- 1 tesoura.
- 1 Par de luvas de látex.
- 1 toalhita de sabão.
- 2 Toalhitas de álcool.
- 2 pensos para cortes.

- 25Gr. De algodão.
- 5 Pensos para queimaduras 20x20cm.
- 1 Liga.
- 1 rolo adesivo.
- Medidas saco: 180 x 130 x 55mm.



## PORTA-PLACA DE MATRICULA ANÔNIMA

51412 2,10€

0,09	-	100	3000
Kg	Sub	ff	

- Medidas : 53,20 cm x 13,70 cm.
- Área de escrita : 52 cm x 1,60 cm.

FOTOLITO E TELA NÃO INCLUI

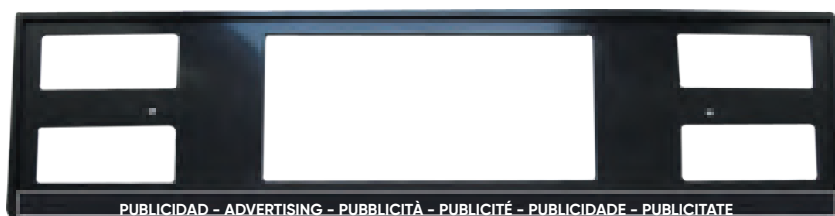

PUBLICIDAD - ADVERTISING - PUBBLICITÀ - PUBLICITÉ - PUBLICIDADE - PUBLICITATE

# SUPORE DE REPARO DE BICICLETAS

**53919** 81,00€

7,85 - 1 28  
Kg SUB

**30 KG**

PARA TODOS OS TIPOS DE BICICLETAS  
CIDADE / ESTRADA / MONTANHA

GRAMPO  
AJUSTÁVEL DE  
LIBERAÇÃO  
RÁPIDA (360°)

- Material: aço Q195, ABS, nylon
- Dimensões montadas: 198x104 cm
- Altura ajustável: 107-188 cm
- Comprimento do tubo transversal giratório: 37 cm
- Comprimento do suporte: 69 cm
- Diâmetro do tubo transversal giratório: 35 mm
- Diâmetro do tubo telescópico: 35 mm
- Diâmetro do tubo principal: 38 mm
- Diâmetro do tubo de suporte: 25 mm
- Capacidade máxima de levantamento: 30 kg



De material reforçado do ABS e de nylon para girar a bicicleta em qualquer ângulo e sem danificar a pintura.



DIMENSÕES DA BANDEJA MULTIFUNENCIONAL DE FERRAMENTAS  
25x13cm



DESIGN ANTIDERRAPANTE 4 PÉS

HASTE AJUSTÁVEL DE FIXAÇÃO: 50-90CM

## BOMBA DE PÉ PARA PNEUS DE BICICLETA

**54166** 32,40€

0,90 - 5 100  
Kg SUB

32mm 530mm



## BOMBA DE MÃO PORTÁTIL PARA BICICLETA

**54170** 16,50€

0,12 - 5 50 2560  
Kg SUB

21mm 195mm



100 PSI AI

## CONJUNTO DE FERRAMENTAS DE BICICLETA - 20 PÇS

**54073** 70,00€

2,00 - 5 240  
Kg SUB

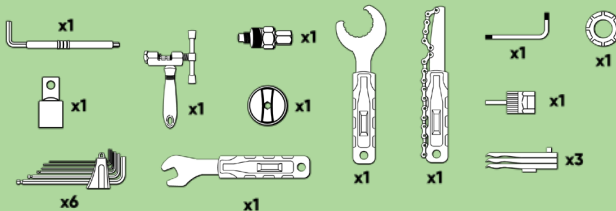

## FERRAMENTA MULTIFUNENCIONAL DE REPARO DE BICICLETAS

**54074** 18,50€

0,17 - 12 48 1008  
Kg SUB



## CADEADO DE COMBINAÇÃO PARA BICICLETA

**54169** 13,80€

0,30 - 5 60 360  
Kg SUB

S PVC  
10mm 1000mm





## PÁ DOBRÁVEL

**51858** 15,00€



- Fabricado com metal resistente.
- Fexada: 240mm.
- Aberta: 600mm.



## PÁ COM CABO EXTENSÍVEL

**53033** 21,50€

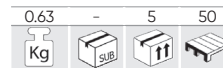

## PÁ METÁLICA COM CABO DE MADEIRA

**52187** 21,80€



## PÁ METÁLICA COM CABO DE MADEIRA

**52251** 21,80€

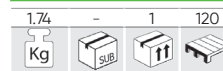

## SENSOR DE ESTACIONAMENTO COM MEDIDOR DE DISTÂNCIA VISUAL E ACÚSTICO

**51863** 54,00€



- Voltagem nominal: DC 12 V.
- Potência: 3,6 W.
- Temperatura de trabalho: -20° a 70°.
- 4 sensores de DISTÂNCIA.
- Distância de detecção: 0,3-2,0 m.
- Ângulo de detecção: H>60°, V>60°.
- Rádio frequência: 315 MHz / 433 MHz.
- Inclui indicador de 2 cores do marcador de DISTÂNCIA.
- Sensores pretos. Não se podem pintar.



## CORDA MULTIUSOS 30M

**53964** 9,65€



Ø 1/4" 550 Kg 30M

**53965** 25,80€



Ø 1/2" 1.200 Kg



## SENSOR DE ESTACIONAMENTO COM MEDIDOR DE DISTÂNCIA ACÚSTICO

**51973** 45,00€



- Voltagem nominal: DC 12 V.
- Potência: 3,6 W.
- Temperatura de trabalho: -20° a 70°.
- 4 sensores de DISTÂNCIA.
- Distância de detecção: 0,3-2,0m.
- Ângulo de detecção: H>60°, V>60°.
- Rádio frequência: 315 MHz / 433 MHz.
- Sem indicador visual.
- Inclui buzzer de 4cm diâmetro.
- Sensores pretos. Não se podem pintar.



## SENSOR DE ESTACIONAMENTO 8 PINS

**52742** 64,00€



x8

- Alarme de voz disponível.
- 4 sensores traseiros (+ 4 da frente).
- Resistente à chuva.
- Peças disponíveis.
- Pins re-pintáveis.



## TAPETE DE BORRACHA UNIVERSAL - REVERSIBLE

**50585** 14,70€

2,86 - 8 208



- Borracha de alta qualidade.
- Muito resistente.
- Adaptável à maioria de veículos.



EXPOSITOR PARA TAPETE

**METEXP**

62,00€

6,00 - 1

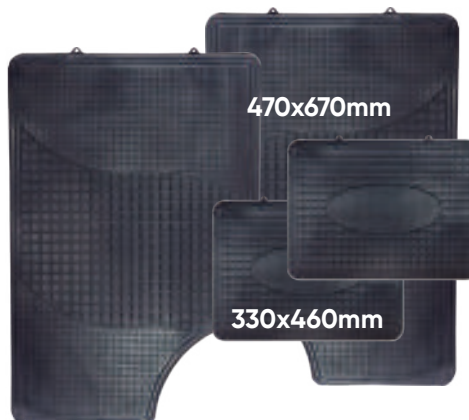

REVERSIBLE!



## TAPETE DE BORRACHA UNIVERSAL

**53241** 9,00€

1,65 - 12 288



- Borracha de alta qualidade.
- Muito resistente.
- Adaptável à maioria de veículos.



3 PCS



EXPOSITOR PARA TAPETE

**METEXP**

62,00€

6,00 - 1



## TAPETE DE TELA UNIVERSAL

**52530** 14,00€

2,00 - 8 160



- 2 frente (390mm) + 2 traseiras (365x480mm).
- Apresentação: Cabide.

- Leve, confortável, com salto.
- Reverso com pregos de borracha.



EXPOSITOR PARA TAPETE

**METEXP**

62,00€

6,00 - 1



REVERSO

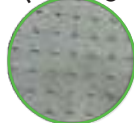

## TALONERA DE TELA UNIVERSAL

### TALONERA COLOR ALUMÍNIO

**52534** 15,00€

1,55 - 8 160



- 2 frente (425x660mm) + 2 traseiras (295x425mm).

- Leve, confortável, com salto.
- Reverso com pregos de borracha.



52534

52535

### TALONERA TELA

**52535** 16,50€

1,55 - 8 160



EXPOSITOR PARA TAPETE

**METEXP**

62,00€

6,00 1 25





# LIMPADOR DE PARA-BRISA



**FÁCIL  
INSTALAÇÃO**

**GRANDE POTÊNCIA LIMPADORA  
DE ALTA VELOCIDADE**

**99%**

Fácil instalação do adaptador em mais de 99% dos veículos.

**38dB**

A ergonomia e a eliminação de peças de peso reduzem o ruído em 38db.

**30%**

Pressão uniforme em todo o comprimento da escova, graças à mola de aço para maior visibilidade do que os pincéis originais e desempenho superior de 30%.

**100%**

100% de borracha natural resistente a todas as condições climáticas extremas.

**160km/h**

Projeto aerodinâmico que permite o uso até 160 km/h.

**45°**

Ângulo de corte de 45° e precisão da limpeza transversal que elimina o maior número de quedas de gotas a mais.



**11 ADAPTADORES DIRE-  
FENTES:  
PARA VÁRIOS APLICATIVOS**



REF.	DESCRIÇÃO	Kg	Ca	Ca	Ca	€
53745	11" 280mm	0,20	10	50	800	6,40€
53746	12" 310mm	0,20	10	50	800	6,40€
53747	13" 330mm	0,20	10	50	600	6,40€
53748	14" 350mm	0,20	10	50	800	6,60€
53749	15" 380mm	0,20	10	50	800	6,70€
53750	16" 410mm	0,20	10	50	800	6,70€
53751	17" 430mm	0,20	10	50	550	6,80€
53752	18" 460mm	0,25	10	50	800	6,95€
53753	19" 480mm	0,25	10	50	600	7,10€
53754	20" 510mm	0,25	10	50	600	7,40€
53755	21" 530mm	0,25	10	50	600	7,50€
53756	22" 560mm	0,25	10	50	700	7,90€
53757	24" 610mm	0,25	10	50	550	7,90€
53758	26" 650mm	0,30	10	50	550	8,20€
53759	28" 700mm	0,30	10	50	550	8,50€
53760	30" 750mm	0,30	10	50	500	9,60€



**12  
PCS**

## EXPOSITOR

**JBMWBEXP 24,50€**

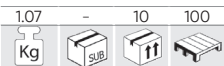

ESCOVAS DE  
LIMPA VIDROS

## CONTRAPESOS DE CLIP ADESIVA EM PASTILHA DE 45g. (TIRAS DE 5g - 10g - 5g - 10g - 5g - 10g)

**50600** 0,60€

0,05 100 400 36000

Kg SUB SUB SUB

ZINC



**50601** 0,29€

0,05 100 400 48000

Kg SUB SUB SUB

FERRO



## CONTRAPESOS DE CLIP ADESIVAS EM PASTILHAS 60g

**52665** 0,37€

0,06 100 400 37600

Kg SUB SUB SUB

5gr x 12 u.



- Ferro.  
- Adesivo grande aderência e durabilidade.

**52666** 0,36€

0,06 100 400 37600

Kg SUB SUB SUB

5gr x 4 u. 10gr x 4 u.

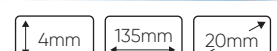

## CONTRAPESO COM GRAPA DE ZINC ESPECIAL PARA JANTE UNIVERSAL

REF.	g.	Kg	Sub	Box	Tray	€
50760	5g.	0.01	100	1600	80000	0,10€
50761	10g.	0.01	100	1600	102400	0,19€
50762	15g.	0.02	100	800	76800	0,29€
50763	20g.	0.02	100	800	64000	0,38€
50764	25g.	0.03	100	800	48000	0,49€
50765	30g.	0.03	100	600	50400	0,58€
50766	35g.	0.04	100	400	32000	0,68€
50767	40g.	0.04	100	400	25600	0,78€
50768	45g.	0.05	100	400	32000	0,88€
51055	50g.	0.05	100	400	2000	0,98€

## CONTRAPESO COM GRAPA DE ZINC ESPECIAL PARA JANTE FRANCESA

REF.	g.	Kg	Sub	Box	Tray	€
50771	15g.	0.03	100	600	6600	0,29€
50774	30g.	0.03	100	1200	3300	0,57€
50776	40g.	0.04	100	400	2500	0,76€
51056	50g.	0.05	100	400	2000	0,75€

## CONTRAPESO COM GRAPA DE ZINC ESPECIAL PARA JANTE ALUMINIO

REF.	g.	Kg	Sub	Box	Tray	€
50778	5g.	0.01	100	1600	80000	0,10€
50779	10g.	0.01	100	800	76800	0,19€
50780	15g.	0.02	100	1200	60000	0,29€
50781	20g.	0.02	100	800	80000	0,38€
50782	25g.	0.03	100	800	48000	0,49€
50783	30g.	0.03	100	600	30000	0,58€
50784	35g.	0.04	100	400	32000	0,68€
50785	40g.	0.04	100	400	32000	0,78€
50786	45g.	0.05	100	400	32000	0,88€
51604	50g.	0.05	100	400	2000	0,98€



## CONTRAPESO UNIVERSAL CAMINHÃO

SEGMENTAÇÃO DE 50G

**52667** 0,76€

0,05 50 400 25600

Kg SUB SUB SUB



SEGMENTAÇÃO DE 100G

**52668** 1,49€

0,10 25 200 12800

Kg SUB SUB SUB



SEGMENTAÇÃO DE 150G

**52669** 2,22€

0,15 20 160 10240

Kg SUB SUB SUB



SEGMENTAÇÃO DE 200G

**52670** 2,95€

0,20 10 80 5120

Kg SUB SUB SUB



SEGMENTAÇÃO DE 250G

**52671** 3,70€

0,25 10 80 5120

Kg SUB SUB SUB



SEGMENTAÇÃO DE 300G

**52672** 4,45€

0,30 10 80 5120

Kg SUB SUB SUB





# DISPENSADOR DE CONTRAPESOS AUTO-ADESIVOS PASTILHAS DE FERRO DE 5g

- 1.000 pastilhas de 5g de Contrapesos de ferro. / Auto-adesivos 4mm espessura. / Medidas do dispensador: 29,5 cm x 29,5 cm.

**51908** 44,00€

5,60 - 4 - 240

Kg SUB



**53256** 34,00€

5,30 - 4 - 240

Kg SUB



Com imán de retenção dos contrapesos restantes.

## CAIXA DE CONTRAPESOS SURTIDO

**53864** 138,00€

10,50 - 1 - 71

Kg SUB

CONTRAPESOS DE CLIP ADESIVOS EM PASTILHAS  
60gr: 4x10gr 4x5gr - 70u. (ref. 52666)

80mm  
540mm  
280mm



### CONTRAPESOS DE ZINC COM GRAPA

#### PARA JANTE UNIVERSAL

- 5g - 20 uds (ref. 50760)
- 10g - 20 uds (ref. 50761)
- 15g - 20 uds (ref. 50762)
- 20g - 20 uds (ref. 50763)
- 25g - 20 uds (ref. 50764)
- 30g - 10 uds (ref. 50765)
- 35g - 10 uds (ref. 50766)
- 40g - 10 uds (ref. 50767)

#### PARA JANTE ALUMÍNIO

- 5g - 20 uds (ref. 50778)
- 10g - 20 uds (ref. 50779)
- 15g - 20 uds (ref. 50780)
- 20g - 20 uds (ref. 50781)
- 25g - 20 uds (ref. 50782)
- 30g - 10 uds (ref. 50783)
- 35g - 10 uds (ref. 50784)
- 40g - 10 uds (ref. 50785)

## KIT DE REPARAÇÃO DE PNEUS COMPRESSOR DE LÍQUIDO E AR

**54013** 35,00€

1,15 - 5 - 20 - 200

Kg SUB

- Veda furos de até 6 mm de diâmetro.
- Até 60 furos podem ser evitados aplicando líquido no pneu uma vez.
- O material não corrói metais e borracha.
- Fluido de longa duração, não inflamável e resistente ao congelamento.

**SELANTE DE PNEU - 500 ML**

**15300** 5,00€

0,50 - 12 - 936

Kg SUB



**EXTRACTOR OBUSES**

**11960** 1,50€

0,01 - 10 - 500

Kg SUB



**BOLSA PARA CONJUNTO**

**15317** 4,50€

0,10 - 500

Kg



**COMPRESSOR DE AR**

**53150** 24,00€

0,55 - 10 - 40 - 640

Kg SUB



## COMPRESSOR DE AR

**53150** 24,00€

0,55 - 10 - 40 - 640

Kg SUB

120mm 165mm 55mm

- Aplicar aos carros: Carro de família, SUV., etc.



- DC 12V
- 100W
- 150 PSI 10 BAR
- 10A
- 16L/min
- 30mm

## VÁLVULAS TPMS

**12902** 4,50€

0,01 - 4 - 100 - 1500

Kg SUB

4,25 Nm  
OE 72-20-223

**12920** 7,80€

0,02 - 4 - 100 - 1500

Kg SUB

4 Nm (screw)  
4 Nm (nut)

**12910** 4,40€

0,01 - 4 - 100 -

Kg SUB

75 Nm  
OE 72-20-206, TPK65655

**12924** 4,10€

0,01 - 4 - 100 - 1500

Kg SUB

1,4 Nm (screw)  
4,0 Nm (nut)  
OE 72-20-116

**53723** 68,00€

0,05 - 50 - 6000

Kg SUB

EU-PRO HYBRID 3.5

**12908** 4,50€

0,01 - 4 - 100 -

Kg SUB

4,25 Nm  
OE 72-20-205, TPK65654

**12923** 9,50€

0,01 - 4 - 100 - 1500

Kg SUB

8 Nm  
OE TPK43211

**12915** 12,40€

0,04 - 4 - 100 - 1000

Kg SUB

8 Nm (nut)  
1,4 Nm (screw)  
OE 72-20-116

**12925** 10,70€

0,02 - 4 - 100 -

Kg SUB



# SET DE REPARAÇÃO DE PNEUS

**52662** 36,50€



- 1 x Broca
- 1 x Broca para inserir pavios
- 1 x Util para encher pneus
- 4 x Garrafas de ar 16gr
- 1 x Cuter
- 10 x Pavios
- 1 x Chave multifuncionais obuses

**52663** 30,00€



- 1 x Broca para inserir pavios
- 1 x Ponta para broca de pavios
- 1 x Broca de perfuração
- 1 x Cuter
- 20 x Pavios
- 1 x Lubrificante

## PAVIO DE SUBSTITUIÇÃO PARA REF. 52662 / 52663

**12973** 1,00€

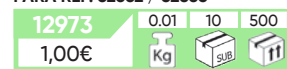

## BROCA DE PERFURAÇÃO REF. 52663

**13806** 10,50€

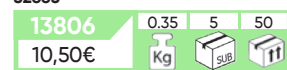

## BROCA DE INSERÇÃO DE PAVIOS REF. 52663

**13805** 10,50€

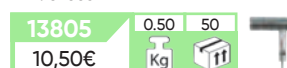

## FERRAMENTA PARA OBUSES

**52653** 3,00€



- Para posicionar e desposicionar obuses.

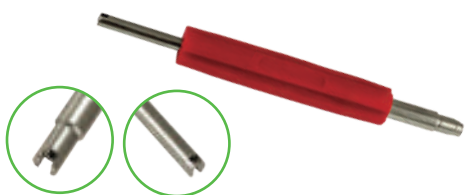

## CHAVE MULTIFUNCIONAL PARA OBUSES

**52652** 2,80€

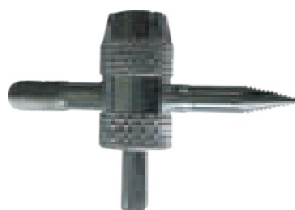

## ALICATE ESPECIAL PARA PESOS

**51355** 19,00€



- Tira facilmente e substitui o peso.  
- Corta e dobra com facilidade.  
- Feito de aço reforçado.  
- Inclui cabo ergonómico.  
- Com mola automática para manter a sua abertura e facilitar a operação.



## JOGO DE TAMPÃO E OBUSES PARA PNEUS

**52673** 18,00€

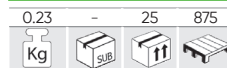

### TAMBÉM DISPONÍVEIS

**11900** 3,50€  
Tampão de alumínio para válvula pneus. Blister de 4 unidades.

**11901** 2,50€  
Tampão de plástico verde para válvula pneus. Blister de 4 unidades.

**11902** 3,50€  
Tampão de plástico preto para válvula pneumático. Blister de 4 unidades.

### CONTÉM:

**11903** 5,00€  
Saco 16 unidades tampão. Alumínio para válvula pneus.

**11905** 1,50€  
Saco 50 unidades tampão. Plástico preto para válvula Pneus.

**11907** 11,00€  
Saco 50 unidades obuses alta Pressão.

**11904** 2,00€  
Saco 50 unidades tampão. Plástico verde para válvula Pneus.

**11906** 8,50€  
Saco 50 unidades obuses. Estandar.

**11960** 1,50€  
Extractor obuses.

## KIT DE FERRAMENTAS PARA MONTAGEM E REMOÇÃO DA VÁLVULA TPMS

**52818** 148,00€

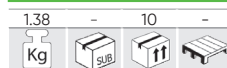

- Definir múltiplas ferramentas especialmente concebidos para fácil montagem e desmontagem dos sensores TPMS.

- 1 2-14 NM
- 2 0,5-3,5 NM
- 3 2x Ø 11, 12mm
- 4 3x T10, T15, T20
- 5 150mm
- 6 2mm
- 7 0,25 Nm
- 8 0,45 Nm

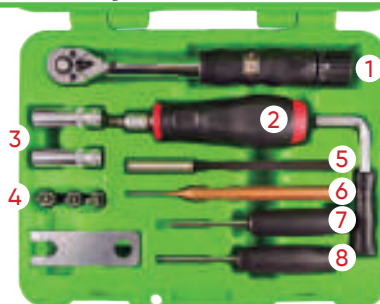



## VÁLVULAS PARA PNEUS

TR413

**51741** 0,50€

0.01	100	1000	48000
Kg	Sub	ff	ff



TR414

**51742** 0,50€

0.01	100	1000	48000
Kg	Sub	ff	ff



TR418

**51743** 0,55€

0.02	100	1000	48000
Kg	Sub	ff	ff



x100

## FERRAMENTA PARA INSTALAR VÁLVULAS DE PNEUS

- Para posicionar válvulas de pneus.

METAL

**52649** 5,00€

3.20	10	50	2250
Kg	Sub	ff	ff



PLÁSTICO

**52650** 5,00€

0.15	10	100	2400
Kg	Sub	ff	ff



## ROLO PARA REPARAÇÃO DA PNEUMÁTICO

**52842** 11,00€

0.15	10	100	1500
Kg	Sub	ff	ff

38mm



## KIT DE 3 PROTETORES DE RODA

**53419** 9,70€

0.10	10	100	600
Kg	Sub	ff	ff

3 PCS



## CHAVE DE RODA JUNTA SOLDADA

**51661** 12,00€

1.17	5	20	480
Kg	Sub	ff	ff

355mm

17, 19, 21mm

1/2"



**52881** 17,00€

1.40	-	10	420
Kg	Sub	ff	ff

400mm

17, 19, 21, 22mm

1/2"



**52880** 42,00€

3.75	-	5	100
Kg	Sub	ff	ff

700mm

24, 27, 32mm

3/4"



## CHAVE DE RODAS EXTENSÍVEL COM CHAVES REVERSÍVEIS

**51416** 12,00€

1.05	10	20	600
Kg	Sub	ff	ff

330-490mm

1/2"



CHAVE CROMADA

21mm / 23mm

17mm / 19mm



## FERRAMENTA DESMONTADORA DE PNEUS

**52657** 37,50€

0.18	5	20	800
Kg	Sub	ff	ff

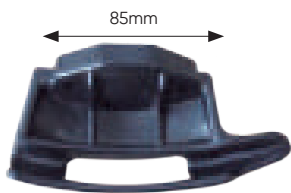

**52658** 39,70€

0.17	-	20	800
Kg	Sub	ff	ff

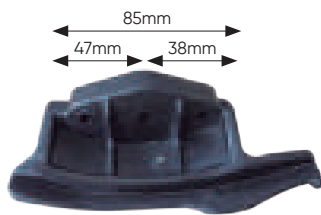

**52659** 39,70€

0.26	-	20	1920
Kg	Sub	ff	ff



## AVALANCA PLASTICA DE REMOVER PNEUS

**52655** 39,70€

0.39	-	25	1500
Kg	Sub	ff	ff

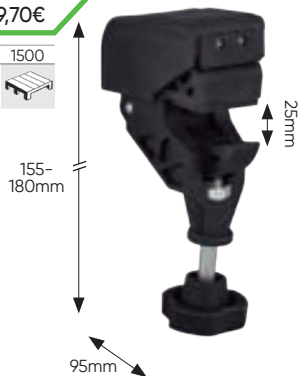

**52656** 39,50€

0.40	5	20	1920
Kg	Sub	ff	ff



## DESMONTADOR DE PNEU MANUAL

**53605** 141,00€

16.00	-	1	21
Kg	Sub	ff	ff

950mm

1 manivela para quebrar o talão do pneu de 37 polegadas de comprimento.  
Ferramentas montadora / desmontadora.

- Aplicabilidade: todos os pneus de 8 polegadas até pneus para caminhões ligeiros (7-1/2 polegadas x 16 polegadas).
- Passabilidade: até 12.5L 16.
- Integridade:



## ALAVANCA PARA PNEUMÁTICOS

**51362** 3,00€

0.15	5	60	500
Kg	Sub	ff	ff

**51358** 7,50€

0.47	6	24	1008
Kg	Sub	ff	ff

**51359** 9,00€

0.90	6	30	1440
Kg	Sub	ff	ff



## ALAVANCA DE MUDANÇA DE RODAS INDUSTRIAIS

**52664** 168,00€

12.30	-	1	15
Kg	Sub	ff	ff



## PORTA PNEUS COM RODAS

**54198** 59,00€

4.25	-	1	35
Kg	Sub	ff	ff

CAP. 136kg  
STEEL  
PP

66x66x11cm

- Quatro rodízios giratórios de 3" (um deles bloqueável).
- Pega única para transporte fácil
- Capacidade de carga: 136 kg
- Dimensões: 66x66x11 cm

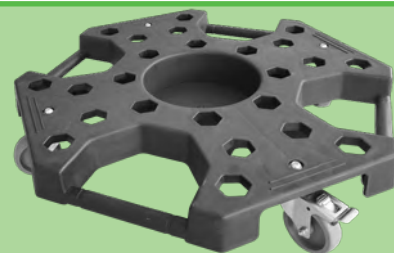

- Peso: 3,4 kg
- Cor: preto
- Material das rodas: aço + TPR
- Material do corpo: plástico

## DESMONTADOR DE PNEU MANUAL

**54136** 107,00€

5.25	-	2	144
Kg	Sub	ff	ff

257mm 162mm 110mm

FOR / PARA

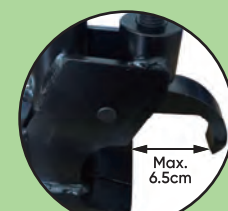



## CARRO PORTA PNEUS

<b>52660</b>	126,00€	<b>52661</b>	290,00€
7,88	-	1	18
Kg	sub	ff	sub

ALTA CAPACIDADE

200Kg

300Kg

590mm

## CALÇADORA DE PNEUS PORTÁTIL

<b>52552</b>	128,00€		
12,00	-	1	15
Kg	sub	ff	sub

18L

-20°C  
40°C

5-8 BAR  
(87-116 PSI)

MAX.  
10 BAR  
145 PSI

BOQUILHA DE REPOSIÇÃO PARA 52552

<b>13741</b>	21,00€		
0,35	-	32	-
Kg	sub	ff	sub

## ABRAÇADEIRAS

<b>11891</b>	0,50€	<b>11890</b>	0,55€
0,01	100	5000	90000
Kg	sub	ff	sub

x100

15-45mm

50-125mm

x100

## PACK DE 2 ABRAÇADEIRAS

<b>52633</b>	1,00€		
0,02	100	800	14400
Kg	sub	ff	sub

50-125mm

15-45mm

UTILIZAR COM ALICATES REF. 52619.

## CASQUILHO CENTRADOR PARA RODAS DE PESADOS

REF.	Kg	sub	ff	sub	€
52645	0,02	50	1.000	38.000	0,55€
52646	0,01	50	1.000	80.000	0,50€
53037	0,01	50	1.000	-	0,50€
53038	0,01	50	1.000	35.000	0,50€
53039	0,02	50	1.000	35.000	0,50€
53040	0,01	50	1.000	35.000	0,50€

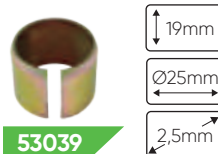
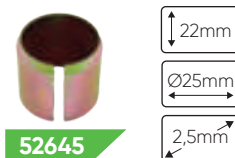

## TUBOS FLEXÍVEL INNERBRAID



REF.	DESCRIÇÃO	Kg	sub	ff	sub	€
51706	Ø 25mmL x 300mmL	0,35	25	1.500	22,80€	
51707	Ø 45mmL x 100mmL	0,27	25	1.200	9,05€	
51708	Ø 45mmL x 150mmL	0,38	25	-	14,20€	
51709	Ø 45mmL x 200mmL	0,50	25	-	14,70€	
51710	Ø 45mmL x 250mmL	0,65	25	600	17,80€	
51711	Ø 45mmL x 300mmL	0,71	25	-	21,20€	
51712	Ø 50mmL x 100mmL	0,30	25	-	8,65€	
51713	Ø 50mmL x 150mmL	0,45	25	-	13,10€	
51714	Ø 50mmL x 200mmL	0,56	25	-	15,80€	
51715	Ø 50mmL x 250mmL	0,70	25	-	20,30€	
51716	Ø 50mmL x 300mmL	0,83	25	450	23,60€	
51717	Ø 55mmL x 100mmL	0,35	25	-	11,20€	
51718	Ø 55mmL x 150mmL	0,50	25	-	14,80€	
51719	Ø 55mmL x 200mmL	0,65	25	-	22,00€	
51720	Ø 55mmL x 250mmL	0,85	25	350	23,50€	
51721	Ø 55mmL x 300mmL	1,00	25	375	25,00€	
51722	Ø 60mmL x 100mmL	0,36	25	-	13,10€	
51723	Ø 60mmL x 150mmL	0,50	25	-	18,70€	
51724	Ø 60mmL x 200mmL	0,66	25	-	24,40€	
51725	Ø 60mmL x 250mmL	0,83	25	-	28,30€	
51726	Ø 60mmL x 300mmL	0,96	25	250	31,40€	
51727	Ø 60mmL x 400mmL	1,62	25	200	49,00€	

## KIT DE FOLE DE TRANSMISSÕES

PARA TURISMO

**51705**

8,45€

0.23	-	20	400
Kg	sub	ff	ff



PARA CARRINHAS

**51703**

10,50€

0.28	-	20	320
Kg	sub	ff	ff



REPOSIÇÃO PARA REF. 51703

**13739**

5,50€

0.15	100	1600
Kg	sub	ff



REPOSIÇÃO PARA REF. 51705

**13738**

3,50€

0.08	150	2400
Kg	sub	ff



## KIT DE FOLE DE TRANSMISSÕES UNIVERSAL

**52644**

8,80€

0.19	-	20	400
Kg	sub	ff	ff

NEOPRENO



LUBRIFICANTE PARA O KIT UNIVERSAL DA MANGA DE PROTEÇÃO

**13880**

1,50€

0.01	600	21000
Kg	sub	ff

REPOSIÇÃO PARA REF. 52644

**13740**

5,50€

0.10	72	-
Kg	sub	ff



## FERRAMENTA P/MONTAR FOLE DE TRANSMISSÕES

**52829**

19,00€

0.45	-	10	200
Kg	sub	ff	ff

EXTERIOR

INTERIOR

Ø 10cm

Ø 9,5cm



## MÁQUINA PNEUMÁTICA PARA MONTAR FOLE DE TRANSMISSÕES

**51861**

199,00€

4.00	-	2	32
Kg	sub	ff	ff

- Material: Alumínio.
- Abertura de 20 a 100mm.
- Pressão: Máx. 9 Bar (125PSI).

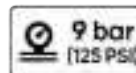

## SÉRIE PROMOCIONAL ESPECIAL KIT FOLE

**SERIE124**

710,00€

22.15	-	-	20
Kg	sub	ff	ff

SAQUETA GORDURA FOLE TRANSMISSÃO

**13879**

1,38€

0.09	-	150	5250
Kg	sub	ff	ff



**51861** x1

**52633** x100

**13738** x100

**13879** x100

## CAIXA DE 100 FOLE DE TRANSMISSÕES

**53693**

521,00€

19.80	-	1	20
Kg	sub	ff	ff



x100  
**13738**



x100  
**52633**



x100  
**13879**

## CAIXA DE 100 FOLE DE TRANSMISSÃO PARA FURGONETA

**53698**

717,00€

19.80	-	1	24
Kg	sub	ff	ff



x100  
**13739**



x100  
**52633**



x100  
**13880**

## CAIXA DE 80 FOLE DE TRANSMISSÃO UNIVERSAL

**53695**

504,00€

11.25	-	1	24
Kg	sub	ff	ff



x80  
**13740**



x80  
**52633**



x80  
**13880**





## **SEGURANÇA E EPI**

- 316 LUVAS / EPIS
- 318 KIT DE PRIMEIROS SOCORROS
- 319 MÁSCARAS / DISPENSADORES
- 320 CÂMERAS TÉRMICAS / TERMÔMETROS  
/ DETERGENTES DE SUPERFÍCIE / LIMPADORES
- 321 DISTÂNCIA DE SEGURANÇA
- 322 DESINFECÇÃO DE ESPAÇOS  
/ MEDIDOR DE OZÔNIO



## LUVAS COM PALMA REFORÇADA DE POLIURETANO

**REF.** 1,54€

0,05	12	144	3456
Kg	sub	ff	ff

**51640N T.8**

**51642N T.9**

**51636N T.10**

**51638N T.11**



EN 388 3131  
CAT - II

## LUVAS COM PALMA REFORÇADA DE NITRILÓ

**REF.** 1,74€

0,04	12	144	3456
Kg	sub	ff	ff

**51633 T.8**

**51634 T.9**

**51632N T.10**

**51398N T.11**



EN 388 3121X  
CAT - II

## LUVAS DE ALGODÃO COM PALMA REFORÇADA DE PONTOS DE BORRACHA

**51785** 0,75€

0,04	12	300	3600
Kg	sub	ff	ff

**CE**



PALMA REFORÇADA

## LUVAS DE ALGODÃO

**51745** 0,70€

0,05	12	144	4320
Kg	sub	ff	ff

**CE**



## LUVAS COM PALMA REFORÇADA DE COURO

**52310** 3,65€

0,20	12	120	1920
Kg	sub	ff	ff

**CE**



## LUVAS DE COURO

**52738** 5,00€

0,10	12	144	2304
Kg	sub	ff	ff

**T. 9**

**CE** EN388: 16 2121X



**52739** 5,00€

0,12	12	144	2304
Kg	sub	ff	ff

**T. 10**



## LUVAS DE TRABALHO

**REF.** 19,00€

0,15	12	60	2040
Kg	sub	ff	ff

**54188 T.8**

**54189 T.9**

**54190 T.10**

**54191 T.11**



EN 388 3131  
CE

## LUVAS TÉRMICAS DE TRABALHO

**REF.** 8,90€

0,15	12	144	3456
Kg	sub	ff	ff

**54192 T.8**

**54193 T.9**

**54194 T.10**

**54195 T.11**



EN 511 EN 388 3131

## LUVAS ANTI-CORTE TACTILES

**52570** 2,60€

0,03	12	144	3456
Kg	sub	ff	ff

**T. 8** EN 388 3131X

**52571** 2,60€

0,03	12	144	2592
Kg	sub	ff	ff

**T. 9** EN 388 3131X

**52572** 2,60€

0,03	12	144	2592
Kg	sub	ff	ff

**T. 10** EN 388 4131

**52573** 2,60€

0,04	12	144	2592
Kg	sub	ff	ff

**T. 11** EN 388 4131

## PARA TELA DE TOQUE



**CE**





# LUVAS DESCARTÁVEIS DE NITRILLO

JBM	REF.	DÉSCRIPT ION	Kg			€	
	3.5 MIL						
	54294	S	0,40	100	10	500	8,80€
	53984	M	0,50	100	10	400	8,80€
	53985	L	0,50	100	10	400	8,80€
	53986	XL	0,55	100	10	400	8,80€



JBM	REF.	DESCRIÇÃO	Kg			€	
	3.5 MIL						
	54155	M	0,50	100	10	570	8,80€
	54156	L	0,50	100	10	570	8,80€
	54157	XL	0,50	100	10	570	8,80€



EN 420: 2003 + AT: 2009



EN ISO 374-5: 2016

JBM	REF.	DESCRIÇÃO	Kg			€	
	5.0 MIL						
	54151	M	0,62	100	10	510	10,90€
	54152	L	0,62	100	10	510	10,90€
	54153	XL	0,67	100	10	510	10,90€



JBM	REF.	DESCRIÇÃO	Kg			€	
	7.0 MIL						
	53551	M	0,90	100	10	300	18,95€
	53552	L	1	100	10	300	18,95€
	53553	XL	1	90	10	300	18,95€



100 PZ

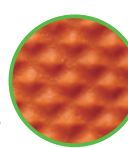

EN ISO 374-5: 2016  
EN 420: 2003 + AT: 2009

JBM	REF.	DESCRIÇÃO	Kg			€	
	7.0 MIL						
	54177	M	0,90	100	10	300	18,95€
	54178	L	0,90	100	10	300	18,95€
	54179	XL	0,90	90	10	300	18,95€



CE

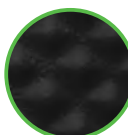

EN ISO 374-1:2016/Type B  
JKPT

**51817** 4,50€

0,13 - 100 2600

Kg SUB

**50966** 4,00€

0,12 - 100 2600

Kg SUB

**50654** 4,00€

0,13 - 100 2600

Kg SUB

Banda marcada

HOMOLOGADO ISO20471:2013



## ÓCULOS ESPORTIVO DE PROTEÇÃO - ANTI-NEVOEIRO

53598 3,95€

CUMPRE COM: EN166:2002-04 / EN166:2003-01

53596 3,65€

53597 3,70€



EM EXPOSITOR DE 12 UDS

0,01	12	144	2016
Kg	sub	ft	ft



53596, 53597, 53598



53597

## ÓCULOS DE PROTEÇÃO - ANTI-NEVOEIRO

53785 4,80€

CUMPRE COM: EN166:2002-04

0,05	14	112	896
Kg	sub	ft	ft

- Proteção direta contra líquidos e bactérias.  
- Alça elástica ajustável.  
- Tratamento de lentes anti-embaciamento.

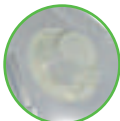

Válvulas incorporadas para evitar o vácuo no interior.



## AUSCULTADORES PARA PROTECCÃO AUDITIVA

52430 10,90€

0,34	6	24	96
Kg	sub	ft	ft



PVC

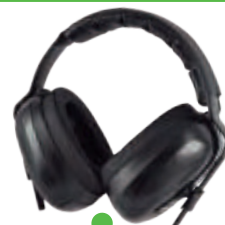

ABS

CUMPRE COM: EN352 - 1:2003

## BOLSA DE PRIMEIROS SOCORROS - DIN13164

54042 13,00€

Um kit de primeiros socorros compacto, ideal para carro e transporte. Fornecido numa bolsa com zíper e velcro na parte traseira.

0,40	-	10	320
Kg	sub	ft	ft

Equipamento:  
Fita adesiva DIN13019-A 5x2,5  
1 conjunto de 14 peças contendo:  
• 4 fitas adesivas DIN 13019-E 10x6  
• 2 adesivos elásticos para os dedos 4x7 cm  
• 2 adesivos elásticos para os dedos 12x2 cm  
• 2 tiras de fita adesiva à prova d'água 1,9x7,2 cm  
• 4 tiras de fita adesivas à prova d'água 2,5x7,2 cm  
1 bandagem estéril DIN 13151-K

6x8 cm  
2 bandagens estéreis DIN 13151-M 8x10 cm  
1 bandagem estéril DIN 13151-G 10x12 cm  
1 bandagem de primeiros socorros DIN 13152-BR 60x40 cm  
1 bandagem de primeiros socorros DIN 13152-A 60x80 cm  
2 bandagens estéreis DIN 61634FB6 6 cm x 400 cm  
3 bandagens estéreis DIN 61634FB6 8 cm x 400 cm

1 manta de resgate 160x210 cm  
6 compressas estéreis para feridas 10x10 cm  
2 bandagens triangulares DIN 13168-D  
1 tesoura DIN 58279-A145 145 cm  
4 luvas descartáveis DIN EN 455-1  
2 lenços umedecidos para limpar pele  
1 lista de conteúdos  
1 guia de primeiros socorros



## MALETA DE PRIMEROS SOCORROS DIN13157: 2021

54072 38,50€

Este kit de montagem em parede inclui as âncoras necessárias para pendurar na parede.

1,55	-	10	120
Kg	sub	ft	ft

Contém:  
1 gesso adesivo 5 x 25 - DIN13019-A  
1 conjunto de bandagens adesivas 10 x 6 cm (8 unid.) - DIN13019-E  
6 remendos de dedo 4 x 6,5 cm  
6 remendos de dedo 120 x 20 mm  
6 remendos de dedo 72 x 19 cm  
12 remendos de dedo 25 x 72 mm  
1 conjunto de bandagens de primeiros socorros, compressa estéril 6 x 8 cm - DIN13151-K  
3 conjuntos de bandagens de primeiros socorros, compressa estéril 8 x 10 cm - DIN13151-M  
1 conjunto de ataduras de primeiros socorros, compressa estéril 10 x 12 cm - DIN13151-G  
1 compressa estéril (curativo de tratamento de queimadura) 60 x 80 cm - DIN13152-A  
3 curativos esterilizados (compressas) 100 x 100 mm, 2 unidades / bolsa - DIN58953-2  
2 tapa-olhos - 55 mm x 75 mm 1,5 g

1 compressa fria para tratamento de emergência, min. 200 cm<sup>2</sup>  
1 manta de primeiros socorros, 160 x 210 cm, 12 microns  
2 bandagens elásticas de acordo com os requisitos da norma (gaze), 6 cm por 400 cm - DIN61634 FB6  
2 bandagens elásticas de acordo com os requisitos da norma (gaze), 8 cm por 400 cm - DIN61634 FB8  
2 bandagens triangulares 96x96x136 cm - DIN13168-D  
1 tesoura de metal 190 mm - DIN58279-B190  
2 sacos de plástico para lixo, 300 x 400 mm, 45 microns  
5 materiais não tecidos 20 x 30 cm, min. 15 g/H9m2  
1 luvas descartáveis de PVC L-AQL15 (conjunto de 4) - DIN EN 455-1  
1 livreto de informações



## BOLSA DE PRIMEROS SOCORROS

51246 6,40€

0,20	-	50	800
Kg	sub	ft	ft

1 Folha de primeiros socorros.  
1 tesoura.  
1 Par de luvas de látex.  
1 toalhita de sabão.  
2 Toalhitas de álcool.  
2 pensos para cortes.

25Gr. De algodão.  
5 Pensos para queimaduras 20x20cm.  
1 Liga.  
1 rolo adesivo.  
Medidas saco:  
180 x 130 x 55mm.





# MÁSCARA DE PROTEÇÃO

## FFP2

- Arco de alumínio para fácil adaptação ao nariz.
- Design arqueado para uma respiração mais suave.
- Elástico de borracha fácil de prender.

**53787** 0,98€

0,01	10	800	6400
Kg	Sub	ff	ff



Penetração do material do filtro	≤ 6%
Vazamento total	≤ 11%
Resistência respiratória máx.	30l/min (inspiração): ≤ 0,70 mbar 95l/min (inspiração): ≤ 2,4 mbar 160l/min (expiração): ≤ 3 mbar

✓ Aprovado de acordo com o regulamento da UE 2016/425  
Está em conformidade com a norma EN149:2001+A1:2009

## COM VÁLVULA

**53844** 2,80€

0,02	3	360	1440
Kg	Sub	ff	ff



Servido em caixas de 3 unidades

✓ Aprovado de acordo com o regulamento da UE 2016/425  
Está em conformidade com a norma EN149:2001

## FFP2

**53946** 0,83€

**53960** 0,98€

**53959** 0,98€

**53961** 0,98€

**537870** 0,98€

**53959** 0,98€



✓ Está em conformidade com a norma EN149:2001+A1:2009  
Aprovado de acordo com o regulamento da UE 2016/425

Penetração do material do filtro	≤ 6%
Vazamento total	≤ 11%
Resistência respiratória máx.	30l/min (inspiração): ≤ 0,70 mbar 95l/min (inspiração): ≤ 2,4 mbar 160l/min (expiração): ≤ 3 mbar

## FFP3

**53916** 3,80€

0,03	10	200	1600
Kg	Sub	ff	ff



- Material de filtro de três camadas (polipropileno).
- Um clipe nasal que garante um ajuste confortável da meia máscara no rosto.
- Válvula de expiração.
- Laços elásticos com elásticos naturais, sem látex.
- Fechos plásticos.
- Revestimento interno para melhor vedação e conforto.

## VÁLVULA DE EXPIRAÇÃO EMBUTIDA

✓ Aprovado de acordo com o regulamento da UE 2016/425  
Está em conformidade com a norma EN149: 2001

Penetração de solução salina (cloreto de sódio) ou partículas de névoa de óleo no material do filtro	≤ 1%
Tempo máximo de uso	8 h

# MÁSCARA DE PROTEÇÃO INDIVIDUAL

## HIGIÊNICA

**53797** 0,10€

0,00	50	2000	24000
Kg	Sub	ff	ff

**53957** 0,26€

0,01	50	2000	24000
Kg	Sub	ff	ff

Eficácia do EFB na filtração bacteriana	>98%
Resistência à respiração	35-50 Pa

✓ UNE 0064-1:2020



USO NÃO MÉDICO  
Apresentação em caixa com 5 sacos de 10 cada.

# TAPETE PARA DESINFECÇÃO DE CALÇADO

## ALCATIFA COM TANQUE PARA LÍQUIDO DESINFECTANTE

**53862** 6,00€

1,45	-	5	100
Kg	Sub	ff	ff

- Medidas: 85x55x10cm
- Material: TPE
- Capacidade máxima recomendada: 3L
- Capacidade máxima: 8L



## TAPETE DE SECAGEM

**53863** 3,00€

0,70	-	5	240
Kg	Sub	ff	ff

- Medidas: 76x48cm
- Material: Poliéster

## LÍQUIDO PARA TAPETE 53862

**53893** 5,00€

4,30	-	4	128
Kg	Sub	ff	ff



# DISPENSADOR DE CAPA DE SAPATO AUTOMÁTICO

**53781** 18,00€

2,20	-	8	32
Kg	Sub	ff	ff

- Permite cobrir os pés com tampas plásticas apenas colocando-os dentro do dispensador. Na parte inferior existem 8 peças de PVC para melhor aderência.



Material: Plástico ABS  
**TAMPA DO SAPATO 100PCS**

**14781** 990€

0,25	-	84	336
Kg	Sub	ff	ff



# DISPENSADOR AUTOMÁTICO 1200ml

**53902** 25,00€

1,15	-	18	144
Kg	Sub	ff	ff

- Dosagem: ajustável de 0,5 ml a 2,5 ml.
- Compatível com sabonete líquido, álcool, desinfetante para mãos e gel.
- Medidas: 100x110x220mm.



DISTÂNCIA DE ATIVAÇÃO SENSOR: 50-150MM



## ADAPTADOR AC/DC 6V 1.5A

**15059** 10,00€

0,10	-	200	-
Kg	Sub	ff	ff

## BATERIA R14 C1.5V

**15062** 1,00€

0,05	24	480	-
Kg	Sub	ff	ff

Inclui suporte e parafusos para fixação na parede.

# DISPENSADOR AUTOMÁTICO 400ML

**53826** 16,00€

0,35	-	40	400
Kg	Sub	ff	ff

- Compatível com sabonete líquido, álcool, gel e desinfetante para as mãos.
- Sensor de movimento infravermelho inteligente.
- Dosagem: 1ml.
- Tensão: 6V (4 pilas de 1,5V).
- Pilhas não incluídas.



# DISPENSADOR PARA GARRAFA

**14793** 12,00€

0,05	-	100	1200
Kg	Sub	ff	ff



## SUPOORTE PARA DISPENSADOR DE GEL AUTOMÁTICO

**53827** 14,00€

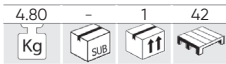

PARA

**53902** 25,00€

- Peso: 4,3kg
- Material: Aço
- Cor: preta
- Medidas da bandeja: 417x67mm
- Medidas do suporte do dispensador: 480x133mm
- Diâmetro da base: 395mm

## TERMÓMETRO DIGITAL

**53794** 28,00€

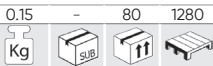

- COMPOSTO COM ALARME SONORO
- INCLUI SMART CHIP E MEMORIZA ATÉ 32 REGISTOS
- ÉCRAN PARA FACILITAR A VISUALIZAÇÃO



distância de medição: 15 - 50mm



CE 0123  
2 pilhas A

Temperatura corporal 32,0°C - 42,2°C (89,6°F - 108°F)  
Precisão ±0,2°C (35°C - 42°C)

- Mede a temperatura corporal em 1 segundo e sem contato.
- Desligamento automático após 1 minuto.

## MÁSCARA DE PROTEÇÃO

**53798** 1,95€

De acordo com a EN166



- Proteção direta contra líquidos e bactérias.
- Espuma no interior para melhorar o conforto.
- Tratamento anti-névoa na tela.
- Ajustável.



## CÂMERA COM SISTEMA DE MEDIÇÃO DE TEMPERATURA

**53830** 1.300,00€

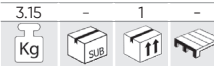

Potência: 12VDC  
Relay: +:NO -:COM  
Internet: RJ45

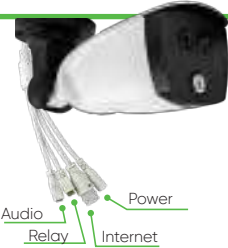

Funciona por conexão IP

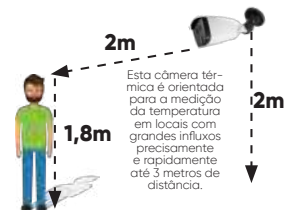

Esta câmara térmica é orientada para a medição da temperatura em locais com grandes influxos precisamente e rapidamente até 3 metros de distância.

## SACO DE PVC COM ZÍPER/ FECHO

**14918** 0,23€

25 x 30cm

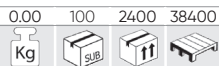

**14919** 0,45€

60 x 18 cm

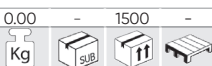

## LÍQUIDO DE LIMPEZA DE SUPERFÍCIES

### FORMATO LÍQUIDO



**53829** 14,00€



**53828** 6,00€



### FORMATO SPRAY

limpa todos os tipos de superfícies: home - carro - escritório - AACC

- Spray ideal para limpar todos os tipos de superfícies.
- Aspecto físico: Líquido transparente.
- Contém: Isopropanol / Etanol.



Acessório útil para utilizar com a maioria de sprays do mercado.

PISTOLA PLÁSTICA PARA LATA DE SPRAY

**53824** 2,85€



**53804** 0,80€

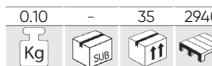

**52493** 4,50€

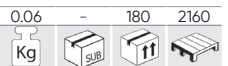

## CUIDADOS E HIGIENE DAS MÃOS: LIMPADORES E FORMULAS HIDROALCOLÓGICAS



- Contém: propan-2-ol, alcohol isopropílico / Etanol / propan-1-ol, n-propanol

Como usar: Aplique uma quantidade suficiente de produto na pele saudável e seca e esfregue por pelo menos 30 segundos. Não precisa ser enxaguado.

### FORMATO GEL



**53832** 1,81€

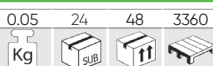

**53791** 4,80€



### FORMATO LOÇÃO

válido para superfícies

- Solução hidroalcoólica com glicerina e aloe vera para higiene e cuidados com as mãos.



**53822** 2,50€

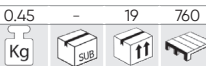

### FORMATO ESPUMA

**53803** 0,90€





## PROTEÇÃO DE METACRILATO

**53835** 16,00€

2,30	-	5	80
Kg	Sub	ff	ff



**53836** 16,00€

4,05	-	5	60
Kg	Sub	ff	ff

Espessura: 5mm  
Buraco: 300x160mm  
Base: 150x200mm

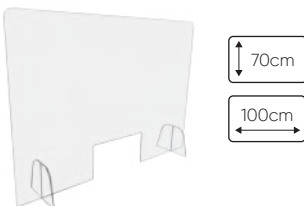

## POSTE DE PLÁSTICO PARA CORRENTE ALTA

**53940** 13,20€

0,55	-	6	96
Kg	Sub	ff	ff

- Material: PVC.

CADEIA NÃO INCLUÍDA

- ✓ Para uma vedação simples, rápida e móvel de áreas interiores e exteriores com limitações.
- ✓ Suas cores contrastantes tornam a corrente altamente visível para restringir áreas de alta tensão.

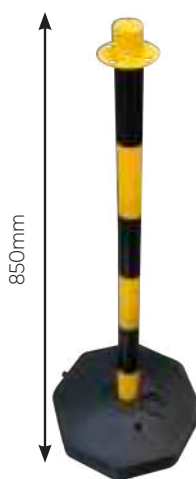

## POSTE DE PLÁSTICO PARA CORRENTE

**53808** 16,50€

0,55	-	6	114
Kg	Sub	ff	ff

- Material: PVC.

CADEIA NÃO INCLUÍDA



BASE INFLÁVEL



## POSTE DE SEPARAÇÃO COM FITA RETRÁCTIL

**53914** 75,00€

8,50	-	5	90
Kg	Sub	ff	ff



- Material: aço
- Diâmetro do tubo: 63 mm
- Diâmetro da base: 320 mm
- Altura: 910 mm

- Fita de 4 lados
- Comprimento da correia: 3 m
- Largura da correia: 48 mm

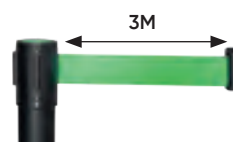

## FITA ADESIVA DE SINALIZAÇÃO DISTÂNCIA DE SEGURANÇA

**53840ES** 6,00€

0,05	10	360	-
Kg	Sub	ff	ff

1.000x1.000 mm

DISPONÍVEL  
EM QUALQUER  
LINGUA

- Texto:  
"¡POR FAVOR! MANTENHA A DISTÂNCIA SEGURANÇA"



## SINAL DE PISO - DISTÂNCIA SEGURA

**53812** 23,50€

0,30	-	-	240
Kg	Sub	ff	ff

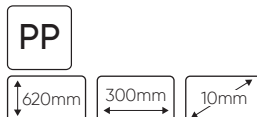

## FITA DE SINALIZAÇÃO 200M

**53811** 8,90€

0,45	-	40	560
Kg	Sub	ff	ff



**53987** 0,59  
9,50€

0,59	-	-	-
Kg	Sub	ff	ff

200M X 10cm



## ELO DE FECHAR

**53942** 0,50€

0,01	50	5000	75000
Kg	Sub	ff	ff



## CORRENTE DE

**53941** 6,05€

0,30	-	40	600
Kg	Sub	ff	ff

- Comprimento: 5m
- Link: 6mm
- Cor: Vermelho / Branco

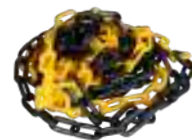

## ELO DE FECHAR

**53839** 0,25€

0,00	10	2000	16000
Kg	Sub	ff	ff



## CORRENTE DE PVC

**53809** 8,00€

0,30	-	40	960
Kg	Sub	ff	ff

- Comprimento: 5m
- Link: 6mm
- Cor: Vermelho / Branco



# GERADOR PORTÁTIL DE OZÔNIO

Desinfecta o ar em salas usando ozônio O3 para oxidar praticamente qualquer partícula: vírus, bactérias, componentes orgânicos e inorgânicos. Uso em áreas desocupadas

OLOR ODORES
VIRUS VIRUSES
BACTERIAS BACTERIA
HCHO
+
HIGIENE
ANTI BACTERIAS
PURIFICA

5.000mg/h

**53786** 98,00€

2,20 - 8 32  
Kg SUB

158mm 172mm 187mm

67W 2 Arms 80 CFM

PLACA PARA REF. 53786  
14775  
30,50€

600mg/h

**53796** 76,00€

0,90 - 8 128  
Kg SUB

15W Q 12V 220V 15m³/h

80mm 130mm 180mm

- LEVE, RÁPIDO E PODEROSO
- BAIXO NÍVEL DE RUÍDO
- TAMANHO PORTÁTIL



IDEAL PARA VEÍCULOS



Conexão à eletricidade e ligação à tomada do isqueiro.

Tempo de operação recomendado de acordo com o tamanho da sala:

50m³ 100m³ 150m³ 200m³ 300m³ 20min 40min 60min 80min 100min

10.000mg/h

**53805** 220,00€

2,80 - 4 40  
Kg SUB

275mm 190mm 235mm

- Leve, rápido e poderoso.
- Baixo nível de ruído.
- 3 tipos de desinfecção: ozônio, ion, ozônio + ion
- Modelo com temporizador e espera
- Tamanho portátil com alça.



95W Q 1000mg/h 220V 240V 30000 h

PLACA PARA REF. 53805

14802  
44,00€

Volume do quarto	Tempo de trabalho necessário
50m³	8 min
100m³	16 min
150m³	24 min
200m³	32 min
300m³	48 min

10.000mg/h - 20.000mg/h

**53806** 250,00€

3,90 - 4 32  
Kg SUB

242mm 233mm 300mm

- Leve, rápido e poderoso.
- Baixo nível de ruído.
- Filtro de ar e placa de ozônio facilmente substituíveis.
- Tamanho portátil com alça.
- Dissipador de calor para evitar superaquecimento na placa de ozônio.



UV  
INCORPORA LUZ UV PARA ESTERILIZAR

PLACA PARA REF. 53806

14803  
43,00€

190W Q 120 CFM 220V 240V 20000 h 90 dB

2 MODOS DE POTÊNCIA

LOW 10.000mg/h		HIGH 20.000mg/h	
Volume do quarto	Tempo de trabalho necessário	Volume do quarto	Tempo de trabalho necessário
50m³	8 min	500m³	30 min
100m³	16 min	600m³	40 min
150m³	24 min	700m³	50 min
200m³	32 min	800m³	60 min
300m³	48 min	900m³	70 min
500m³	65 min	1000m³	80 min

## CAIXA ESTERILIZADORA DE DESINFECÇÃO

**53838** 38,00€

1,10 - 8 96  
Kg SUB



TEMPO DE DESINFECÇÃO

50mm 300mm

280mm 220mm 280mm



BOLSILLO POSTERIOR DESMONTABLE

A caixa se monta e desmonta facilmente, facilitando assim seu transporte.



- Comprimento de onda ultravioleta: 254 nm
- Tomada de alimentação: conector micro USB



5V 2W Amp 0.38-0.42 UV 1550 12V 15-20 mA

- HIGIENE
- PODEROSO
- SEGURO E EFICAZ

- ELIMINA OS MAUS ODORES
- RÁPIDO
- TRANSPORTÁVEL

## MEDIDOR DE OZÔNIO

**53802** 120,00€

0,65 - 20 240  
Kg SUB

- Precisão:  $\pm 5\%$  F.S.
- Faixa de medição: 0-50ppm (0-98mg/m<sup>3</sup>)
- Alarma baixa: 5ppm (98mg/m<sup>3</sup>)
- Alarma alta: 10ppm (196 mg/m<sup>3</sup>)
- Tempo de resposta: <30 segundos
- Faixa de temperaturas operacionais: -10°C - 55°C
- Proteção: IP65



109x60x30mm

DOIS NÍVEIS DE ALARME CONFIGURÁVEIS PARA DIFERENTES NÍVEIS DE CONCENTRAÇÃO

TEMPO DE OPERAÇÃO: >8H

TEMPO DE CARREGAMENTO: 4H-6H

em conformidade com: EN61326-1, EN61000-4-2, EN61000-4-3





## CONSUMÍVEIS

- 324 PASSA-CABOS / CAVILHAS
- 325 CHAVES / PARAFUSOS E PORCAS
- 327 REBITES
- 328 ARRUELA
- 331 VÁLVULAS
- 332 O-RINGS / TUBOS DE REDUÇÃO TÉRMICA
- 333 CONECTORES DE MANGUEIRAS / LUBRIFICADORES
- 334 BRAÇADEIRAS / MOLAS / FUSÍVEIS
- 335 TERMINAIS
- 336 CLIPES DE PLÁSTICO

## ESTOJO DE CIRCLIPS TIPO "E"

53348 14,00€

0,30 6 24 672  
Kg SUB ff



150  
PCS



	M1.5	M3	M5	M6	M9	M12	M15	M19	M22
	15 PCS	15 PCS	20 PCS	25 PCS	25 PCS	20 PCS	10 PCS	10 PCS	10 PCS

## ESTOJO DE PASSA-CABOS DE BORRACHA

53349 14,00€

0,25 6 24 672  
Kg SUB ff



125  
PCS



19,5x23 2 PCS	16x24 3 PCS	13x15 3 PCS	11,5x19 4 PCS	10x20 3 PCS	10x12 5 PCS	25 2 PCS	22 3 PCS	19 4 PCS	15 5 PCS
	9,8x11,5 6 PCS	8x14 3 PCS	7,5x13 7 PCS	6x7,5 10 PCS	3,5x6 15 PCS		12 10 PCS	9 20 PCS	7 20 PCS

## ESTOJO DE PASSA-CABOS DE BORRACHA

53370 26,00€

0,30 6 12 -  
Kg SUB ff

190  
PCS



	M2	M3	M4	M5	M6	M8	M10
	25 PCS	25 PCS	30 PCS	30 PCS	30 PCS	20 PCS	20 PCS

## ESTOJO DE PASSADORES ELÁSTICOS

53350 14,00€

0,40 6 24 -  
Kg SUB ff

120  
PCS



1/16x3/16 4u.	3/32x1-1/4 4u.	3/16x1 5u.	1/4x1-3/4 4u.
1/16x5/16 4u.	1/8x5/8 5u.	3/16x1-1/4 5u.	5/16x3/4 4u.
1/16x3/4 4u.	1/8x1 5u.	7/32x5/8 4u.	5/16x1-1/2 4u.
5/64x1/4 4u.	1/8x1-1/4 5u.	7/32x1-1/4 4u.	5/16x2 4u.
5/64x1/2 4u.	5/32x5/8 4u.	7/32x1-3/4 4u.	3/8x3/4 2u.
5/64x1 4u.	5/32x1 4u.	1/4x5/8 4u.	3/8x1-1/2 2u.
3/32x5/8 4u.	5/32x1-1/2 4u.	1/4x1-1/4 4u.	3/8x2 2u.
3/32x1 4u.	3/16x5/8 5u.		

## CAIXA CAVILHAS DE FENDAS SORTIDAS

52027 14,00€

0,90 6 12 432  
Kg SUB ff

365  
PCS



	1,2x25mm 50 PCS	1,6x32mm 50 PCS	2x40mm 50 PCS	2,5x40mm 50 PCS	3,2x40mm 50 PCS
	3,2x50mm 50 PCS	4x50mm 40 PCS	5x63mm 10 PCS	6,3x63mm 15 PCS	

## ESTOJO DE CHAVETAS

53372 26,00€

1,30 6 12 -  
Kg SUB ff

144  
PCS



	3x50mm 50 PCS	4x60mm 30 PCS	5x75mm 20 PCS	6x50mm 20 PCS	6x75mm 16 PCS	8x60mm 8 PCS
--	------------------	------------------	------------------	------------------	------------------	-----------------



## ESTOJO DE PASSADORES COM ANILHA

53371 29,00€

1,45	6	12	288
Kg	Sub	ff	

50  
PCS



	5x36	6x45	8x45	11x45
	16 PCS	18 PCS	6 PCS	10 PCS

## ESTOJO DE PASSADORES CLEVIS

53363 34,00€

1,15	6	24	-
Kg	Sub	ff	

71  
PCS



	8x50	9,5x50	11x63	12,5x50		3,5x44	2,5x42	2,5x58	2x3
	5 PCS	18 PCS	5 PCS	3 PCS		6 PCS	20 PCS	7 PCS	7 PCS

## ESTOJO CLIPS "R"

52044 19,00€

0,55	6	12	384
Kg	Sub	ff	

150  
PCS



## ESTOJO DE CHAVETAS

53364 16,00€

0,80	6	24	-
Kg	Sub	ff	

60  
PCS



	3x3x25	3x3x20	5x5x30	5x5x25	5x5x20	6x6x40	6x6x30
	4 PCS	4 PCS	5 PCS	5 PCS	5 PCS	5 PCS	5 PCS
	6x6x20	8x8x40	8x8x30	10x10x40	10x10x30	12x12x40	12x12x40
	5 PCS	5 PCS	5 PCS	5 PCS	5 PCS	2 PCS	2 PCS

REPOSIÇÕES DISPONÍVEI



REF.	MEDIDA	UDS.	€/u.
10882	2,00x32mm	42	0,25€
10883	1,60x36mm	30	0,25€
10884	1,60x42mm	25	0,25€
10793	2,30x43mm	25	0,25€
10794	3,20x52mm	20	0,40€
10795	3,80x75mm	8	0,60€

## ESTOJO DE PARAFUSOS DE GANCHO

53352 12,00€

0,60	6	24	672
Kg	Sub	ff	

151  
PCS

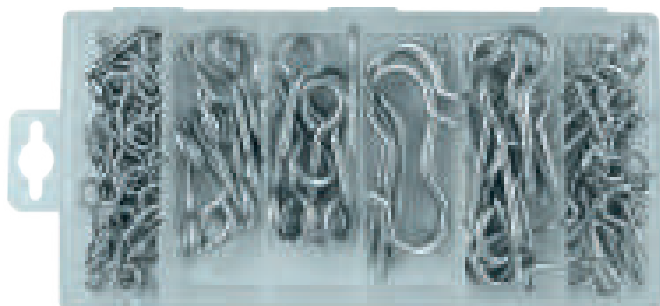

	2,4x25	4x45	4x50
	60 PCS	12 PCS	12 PCS

	2,4x41	4x64	4,2x85
	50 PCS	12 PCS	5 PCS

## ESTOJO DE PARAFUSOS E PORCAS

53351 12,50€

0,90	6	12	-
Kg	Sub	ff	

240  
PCS



	4x12	4x20	5x16	5x25		4	5	6	8	10
	10 PCS	10 PCS	10 PCS	10 PCS		20 PCS	20 PCS	20 PCS	10 PCS	10 PCS
	6x20	6x30	8x25	8x40		4	5	6	8	10
	10 PCS	10 PCS	5 PCS	5 PCS		20 PCS	20 PCS	20 PCS	10 PCS	10 PCS
	10x16	10x40				4	5	6	8	10
	5 PCS	5 PCS				20 PCS	20 PCS	20 PCS	10 PCS	10 PCS

## ESTOJO DE PARAFUSOS AUTORROSCANTES

53354 14,00€

0,55	6	24	-
Kg	Sub	ff	ff

200 PCS



#8x12.5	#8x16	#8x19	#8x25	#10x12.5	#10x16	#10x19	#10x25
30 PCS	30 PCS	30 PCS	30 PCS	20 PCS	20 PCS	20 PCS	20 PCS

## ESTOJO DE PARAFUSOS ALLEN

53362 14,00€

0,65	6	24	672
Kg	Sub	ff	ff

106 PCS



4x12	5x12	5x25	10x40	6x25	8x40	10x25	6x12	8x25
25 PCS	25 PCS	20 PCS	3 PCS	10 PCS	5 PCS	3 PCS	10 PCS	5 PCS

## ESTOJO DE PARAFUSOS E PORCAS TIPO U

53366 14,00€

0,30	6	24	672
Kg	Sub	ff	ff

170 PCS



M3 5X8	M4 2X16	M4.2	M3.5	M3.5
40 PCS	20 PCS	20 PCS	20 PCS	20 PCS
M6.35X19	M5X12	M5	M5	M6.35
15 PCS	10 PCS	15 PCS	15 PCS	10 PCS

## ESTOJO DE PARAFUSOS

53369 14,00€

0,65	6	24	672
Kg	Sub	ff	ff

550 PCS



2.8X13mm	3.5x13mm	3.5x19mm	4.2x16mm	4.2x31mm	4.8x25mm	2.8x16mm
65 PCS	65 PCS	45 PCS	40 PCS	20 PCS	20 PCS	55 PCS
3.5x10mm	3.5x16mm	4.2x13mm	4.2x25mm	4.8x19mm	4.8x32mm	
60 PCS	60 PCS	50 PCS	30 PCS	25 PCS	15 PCS	

## CAIXA PORCAS AUTOBLOCANTES

52029 14,00€

1,01	6	12	360
Kg	Sub	ff	ff

228 PCS



M3	M4	M5	M6	M8
50 PCS	50 PCS	40 PCS	30 PCS	20 PCS
M10	M12	M14	M16	
15 PCS	10 PCS	8 PCS	5 PCS	

## CAIXA DE PORCAS

52028 15,20€

1,05	6	12	360
Kg	Sub	ff	ff

243 PCS



### REPOSIÇÕES DISPONÍVEI

REF.	MEDIDA	UDS.	€/u.
10805	M3	50	0,10€
10779	M4	50	0,05€
10780	M5	50	0,05€
10781	M6	50	0,05€
10784	M8	50	0,05€
10785	M10	20	0,10€
10786	M12	40	0,15€

REF.	MEDIDA	UDS.	€/u.
10812	M14	8	0,30€
10813	M16	5	0,30€





## ESTOJO DE PORCAS BOLBOLETA

53365 14,00€

0,75	6	24	-
Kg	Sub	ff	



150  
PCS



	M4	M5	M6	M8	M10
	40 PCS	40 PCS	25 PCS	25 PCS	20 PCS

## ESTOJO DE REBITES PORCA DE ALUMÍNIO

53361 24,00€

0,20	6	24	672
Kg	Sub	ff	



150  
PCS

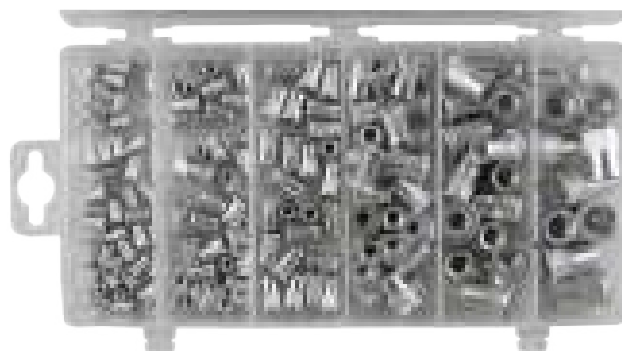

3x9	4x11	5x13	6x15	8x18	10x21
40 PCS	35 PCS	25 PCS	25 PCS	15 PCS	10 PCS

## CAIXA REBITES FÊMEA

52703 22,00€

0,79	6	24	480
Kg	Sub	ff	

235  
PCS



M3	M4	M5	M6	M8	M10	M12
50 PCS	50 PCS	50 PCS	40 PCS	20 PCS	15 PCS	10 PCS

## ESTOJO DE REBITES PORCA

53360 18,00€

0,45	6	24	672
Kg	Sub	ff	



150  
PCS



3x9	4x11	5x13	6x15	8x18	10x21
40 PCS	35 PCS	25 PCS	25 PCS	15 PCS	10 PCS

REPOSIÇÕES DISPONÍVEL

REF.	MEDIDA	UDS.	€/u.
13235	M3	200	0,15€
13236	M4	200	0,15€
13237	M5	200	0,15€
13238	M6	100	0,20€
13239	M8	50	0,20€
13240	M10	40	0,40€
13241	M12	20	0,55€



## CAIXA DE REBITES

52043 16,50€

0,80	6	12	384
Kg	Sub	ff	

300  
PCS



4.8x16.9mm	4.8x24.8mm	
50 PCS	40 PCS	
3.2x9.7mm	4.8x12.7mm	4.8x20mm
90 PCS	70 PCS	50 PCS

## CAIXA DE REBITES PLÁSTICO

52711 27,50€

0,44	6	24	384
Kg	Sub	ff	



150  
PCS

MÁQUINA DE REBITES DE AR DISPONÍVEL EM PAG.48 E 127 (REF. 52575)



REPOSIÇÕES DISPONÍVEL



REF.	MEDIDA	UDS.	€/u.
13674	6x19,3mm	25	0,50€
13675	6x17,8mm	25	0,50€
13676	6x25,5mm	25	0,50€
13677	6x24,5mm	25	0,50€
13678	6x24mm	25	0,50€



6x19.3mm	6x17.9mm	6x25.5mm
25 PCS	25 PCS	25 PCS
6x24.5mm	6x24mm	6x24mm
25 PCS	25 PCS	25 PCS



REPOSIÇÕES DISPONÍVEL

REF.	MEDIDA	Kg	U	U	€/u.
10877	4,8x16,90mm	0,04	5	500	2.000,025€
10878	4,8x24,80mm	0,01	10	500	1.800,030€
10879	3,2x9,70mm	0,02	10	500	4.000,020€
10880	4,8x12,70mm	0,03	10	500	2.000,020€
10881	4,8x20,00mm	0,04	10	500	1.480,025€



# CAIXA SURTIDA DE PARAFUSOS, FÊMEAS E ANILHAS

**51804** 58,00€

5,68 - 5 120  
Kg SUB

**828**  
PCS

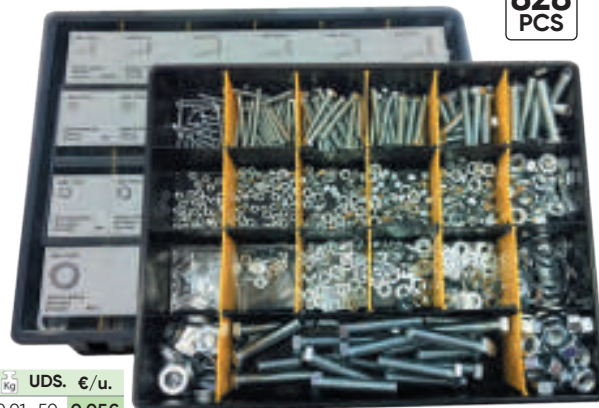

## REPOSIÇÕES DISPONÍVEI

REF.	MEDIDA	Kg	UDS.	€/u.
10772	Tornillo Zincado DIN 933 8.8 M4x25	0,01	25	0,05€
10773	Tornillo Zincado DIN 933 8.8 M5x25	0,01	25	0,10€
10774	Tornillo Zincado DIN 933 8.8 M6x25	0,01	25	0,10€
10775	Tornillo Zincado DIN 933 8.8 M7x50	0,01	15	0,15€
10776	Tornillo Zincado DIN 933 8.8 M8x50	0,01	15	0,20€
10777	Tornillo Zincado DIN 933 8.8 M10x50	0,04	12	0,20€
10778	Tornillo Zincado DIN 933 8.8 M12x60	0,05	20	0,35€
10779	Tuerca Zincada DIN 934 M4	0,02	50	0,05€
10780	Tuerca Zincada DIN 934 M5	0,01	50	0,05€
10781	Tuerca Zincada DIN 934 M6	0,01	50	0,05€
10782	Tuerca Zincada DIN 934 M7	0,01	50	0,05€
10784	Tuerca Zincada DIN 934 M8	0,01	50	0,05€
10785	Tuerca Zincada DIN 934 M10	0,01	50	0,10€
10786	Tuerca Zincada DIN 934 M12	0,01	40	0,15€
10787	Arandela Zincada DIN 125 M4	0,01	50	0,05€



REF.	MEDIDA	Kg	UDS.	€/u.
10788	Arandela Zincada DIN 125 M5	0,01	50	0,05€
10789	Arandela Zincada DIN 125 M6	0,01	50	0,05€
10790	Arandela Zincada DIN 125 M7	0,01	50	0,05€
10791	Arandela Zincada DIN 125 M8	0,01	50	0,05€
10792	Arandela Zincada DIN 125 M10	0,01	50	0,05€
10783	Arandela Zincada DIN 125 M12	0,01	50	0,05€
50959	Caja 19 compartimentos	0,7	1	12,00€

# ESTOJO DE ANILHAS DE FERRO GALVANIZADO 475 PEÇAS

**52158** 38,50€

3,45 - 5 90  
Kg SUB

**475**  
PCS

5x20x1,5mm 50 PCS	6x20x1,5mm 50 PCS	7x20x1,5mm 50 PCS
8x20x1,5mm 50 PCS	8x20x1,75mm 50 PCS	10x30x2,5mm 25 PCS
6x30x2mm 25 PCS	7x30x2mm 25 PCS	8x30x2mm 25 PCS
4x11x0,98mm 50 PCS	12x40x3mm 25 PCS	4x20x1,5mm 50 PCS



# ESTOJO DE ANILHAS DE FERRO SOBRE-MEDIDAS

**53377** 20,00€

1,60 - 6 12 -  
Kg SUB

**240**  
PCS

20x6x1.5 20 PCS	20x8x1.5 20 PCS	20x10x1.5 20 PCS	25x6x1.5 20 PCS
32x2x1.5 20 PCS	32x4x1.5 20 PCS	32x6x1.5 20 PCS	32x8x1.5 20 PCS
25x10x1.5 20 PCS	32x10x1.5 20 PCS	32x10x1.5 20 PCS	25x8x1.5 20 PCS

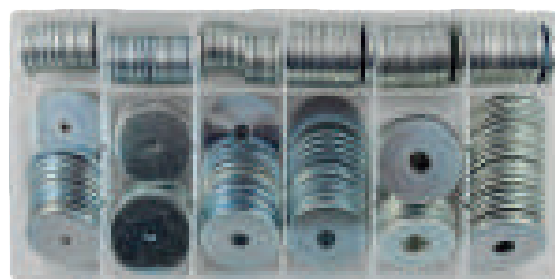

# ESTOJO DE ANILHAS 18 ALUMÍNIO

**52031** 44,00€

0,56 - 6 18 288  
Kg SUB

**900**  
PCS

3x7x1,5mm 50 PCS	4x8x1,5mm 50 PCS	5x6x1,5mm 50 PCS	16x22x1,5mm 50 PCS	14x22x1,5mm 50 PCS	14x20x1,5mm 50 PCS
6x10x1,5mm 50 PCS	6x11x1,5mm 50 PCS	7x11x1,5mm 50 PCS	7x12x1,5mm 50 PCS	8x12x1,5mm 50 PCS	8x14x1,5mm 50 PCS
9x12x1,5mm 50 PCS	10x14x1,5mm 50 PCS	11x16x1,5mm 50 PCS	11x17x1,5mm 50 PCS	12x16x1,5mm 50 PCS	12x16x1,5mm 50 PCS





## ESTOJO DE ANILHAS DE PRESSÃO PRETAS

52032 28,00€

1.735 PCS

1,68 - 5 870  
Kg SUB 11 16



3mm 600 PCS	4mm 400 PCS	5mm 220 PCS	6mm 220 PCS	8mm 110 PCS
10mm 65 PCS	12mm 50 PCS	14mm 40 PCS	16mm 30 PCS	

## ESTOJO DE ANILHAS DE COBRE PARA INJETORES

53229 38,70€

150 PCS



0,40 5 20 720  
Kg SUB 11 16



13.8x7.3x1.4mm 10 PCS	15.0x7.0x2.0mm 10 PCS	15.0x7.5x2.5mm 10 PCS	16.0x7.5x1.7mm 10 PCS	16.0x7.5x2.0mm 10 PCS	16.4x7.5x2.0mm 10 PCS
14.6x7.5x1.3mm 10 PCS	15.0x7.5x1.0mm 10 PCS	15.0x7.5x2.0mm 10 PCS	15.0x7.5x3.0mm 10 PCS	16.0x7.5x1.5mm 10 PCS	20.0x9.4x0.9mm 10 PCS
14.6x7.5x3.0mm 10 PCS	15.0x7.5x1.5mm 10 PCS	15.5x7.5x2.0mm 10 PCS			

53340 86,00€

375 PCS



0,90 - 10 1050  
Kg SUB 11 16

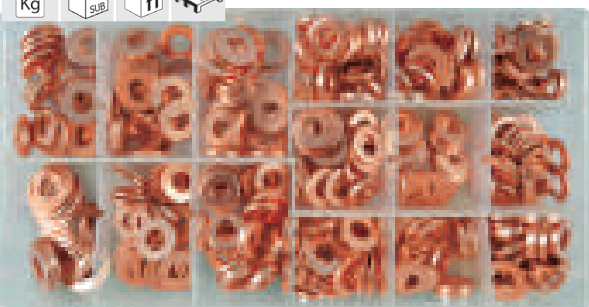

13.8x7.3x1.4mm 25 PCS	15.0x7.0x2.0mm 25 PCS	15.0x7.5x2.0mm 25 PCS	15.5x7.5x2.0mm 25 PCS	16.0x7.5x2.0mm 25 PCS
14.6x7.5x1.3mm 25 PCS	15.0x7.5x1.0mm 25 PCS	15.0x7.5x2.5mm 25 PCS	16.0x7.5x1.5mm 25 PCS	16.4x7.5x2.0mm 25 PCS
14.6x7.5x3.0mm 25 PCS	15.0x7.5x1.5mm 25 PCS	15.0x7.5x3.0mm 25 PCS	16.0x7.5x1.7mm 25 PCS	20.0x9.4x0.9mm 25 PCS

REPOSIÇÕES DISPONÍVEI

13819 50 6,50€ 13.8 x 7.3 x 1.4 mm	13822 50 11,00€ 15.0 x 7.0 x 2.0 mm	13825 50 11,50€ 15.0 x 7.5 x 2.0 mm	13828 50 11,50€ 15.5 x 7.5 x 2.0 mm	13831 50 12,60€ 16.0 x 7.5 x 2.0 mm
13820 50 7,00€ 14.6 x 7.5 x 1.3 mm	13823 50 6,00€ 15.0 x 7.5 x 1.0 mm	13826 50 13,00€ 15.0 x 7.5 x 2.5 mm	13829 50 10,50€ 16.0 x 7.5 x 1.5 mm	13832 50 13,00€ 16.4 x 7.5 x 2.0 mm
13821 50 14,00€ 14.6 x 7.5 x 3.0 mm	13824 50 8,00€ 15.0 x 7.5 x 1.5 mm	13827 50 15,00€ 15.0 x 7.5 x 3.0 mm	13830 50 10,50€ 16.0 x 7.5 x 1.7 mm	13833 50 9,00€ 20.0 x 9.4 x 0.9 mm

## ESTOJO DE ANILHAS 18 COBRE

52030 98,00€

900 PCS

1,21 3 18 288  
Kg SUB 11 16



REPOSIÇÕES DISPONÍVEI

REF.	MEDIDA	Kg	€/u.
10823	3x7x1,5mm	0,01 50	0,20€
10824	4x8x1,5mm	0,01 50	0,20€
10825	5x6x1,5mm	0,01 50	0,20€
10826	16x22x1,5mm	0,01 50	0,40€
10827	14x22x1,5mm	0,01 50	0,60€
10828	14x20x1,5mm	0,01 50	0,45€
10829	6x10x1,5mm	0,01 50	0,20€
10830	6x11x1,5mm	0,01 50	0,20€
10831	7x11x1,5mm	0,01 50	0,20€
10832	7x12x1,5mm	0,01 50	0,20€
10833	8x12x1,5mm	0,01 50	0,20€
10834	8x14x1,5mm	0,01 50	0,25€
10835	9x12x1,5mm	0,01 50	0,25€

REF.	MEDIDA	Kg	€/u.
10836	10x14x1,5mm	0,01 50	0,30€
10837	11x16x1,5mm	0,01 50	0,30€
10838	11x17x1,5mm	0,01 50	0,30€
10839	12x16x1,5mm	0,01 50	0,40€
10840	12x18x1,5mm	0,01 50	0,35€

























# ESTOJO DE ANILHAS DE COBRE PARA INJETORES 551 PCS

53464 153,00€

1,85 - 5 90  
Kg SUB

## 30 REPOSIÇÕES DISPONÍVEL

 UNIVERSAL Ø15.0X8.0X1.5 13945 7,40€	 MERCEDES Ø15.0X7.0X1.5 13946 6,70€	 RENAULT Ø13.0X7.5X2.5 13947 5,85€
 IVECO, FORD, BMW, MAN Ø15.0X7.5X1.5 13948 5,00€	 UNIVERSAL Ø15.0X7.5X2.0MM 13949 6,50€	 UNIVERSAL Ø15.45X8.0X2.0 13950 7,80€
 MAZDA Ø13.5X10X2.0 13951 5,15€	 FORD Ø15.5X7.5X2.5 13952 10,90€	 LAND ROVER Ø15.5X7.5X1.5 13953 8,00€
 RENAULT Ø15.0X7.5X3.0 13954 12,70€	 DEUTZ Ø13.0X7.0X1.5 13955 4,95€	 FORD Ø13.5X7.5X1.5 13956 4,30€
 FIAT Ø15.0X7.5X1.5 13957 9,70€	 MAN ROVER Ø15.5X7.5X1 13958 5,45€	 MERCEDES Ø16.5X7.5X2 13959 10,10€
 KIA Ø13.7X7.3X3 13960 9,65€	 KIA Ø13.7X7.3X2 13961 9,25€	 AÇO Ø10X6.0X1.0 13962 1,76€
 LATÃO Ø15.8X7.5X3.0 13963 12,40€	 CONECTORES DE MANGUEIRA EM "T" 13964 15,00€	 ALUMÍNIO Ø8X5.8X1 13965 1,50€
 CONECTORES DE MANGUEIRA EM "L" 13966 12,90€	 RETENÇÃO SPRINGS 13967 4,65€	







551  
PCS

Ø15.0X8.0X1.5 30 PCS	Ø15.0X7.0X1.5 12 PCS	Ø13.0X7.5X2.5 30 PCS	Ø15.0X7.5X1.5 30 PCS	Ø15.45X8.0X2.0 30 PCS
Ø15.45X8.0X2.0 30 PCS	Ø13.5X10X2.0 12 PCS	Ø15.5X7.5X2.5 30 PCS	Ø15.5X7.5X1.5 12 PCS	Ø15.0X7.5X3.0 30 PCS
Ø13.0X7.0X1.5 12 PCS	Ø13.5X7.5X1.5 30 PCS	Ø15.0X7.5X1.5 12 PCS	Ø15.5X7.5X1 12 PCS	Ø16.5X7.5X2 30 PCS
Ø13.7X7.3X3 12 PCS	Ø13.7X7.3X2 12 PCS	Ø10X6.0X1.0 50 PCS	Ø15.8X7.5X3.0 30 PCS	Ø8X5.8X1 30 PCS
"T" 20 PCS	"L" 30 PCS	retenção springs 25 PCS		



## ANILHAS PARA BUJÃO DE CÁRTER FERRO-BORRACHA

 Ø 10MM / 0,02KG 52719 0,19€ 0.04 100 5000 150000 Kg SUB	 BORRACHA (Ford) Ø 13MM / 0,01KG 51554 0,28€ 0.01 100 5000 180000 Kg SUB	 Ø 16MM / 0,01KG 51799 0,20€ 0.01 50 2500 120000 Kg SUB
 Ø 12MM / 0,03KG 51843 0,19€ 0.01 100 5000 200000 Kg SUB	 Ø 14MM / 0,01KG 51546 0,19€ 0.01 100 5000 150000 Kg SUB	

## CAIXA DE ANILHAS DE COBRE PARA BUJÕES DE CÁRTER

52163 95,00€

0,65 6 18 288  
Kg SUB



Ø10MM 100 PCS	Ø12MM 100 PCS	Ø14MM 100 PCS
Ø16MM 100 PCS	Ø18MM 100 PCS	Ø20MM 25 PCS



COMPRESSÍVEL



525  
PCS



## ESTOJO DE ANILHAS DE COBRE

53353 18,00€

0,20 6 24 720  
Kg SUB ITT



110 PCS



	M6	M8	M10	M12	M14	M16
	30 PCS	25 PCS	20 PCS	15 PCS	10 PCS	10 PCS

## ESTOJO DE ANILHAS DENTADAS INTERIOR

53373 14,50€

0,25 6 24 672  
Kg SUB ITT



260 PCS



	M3x10	M4x12	M5x14	M6x14	M8x18	M10x20	M12x25
	30 PCS	30 PCS	40 PCS	50 PCS	50 PCS	40 PCS	20 PCS

## ESTOJO DE ANILHAS SEGER EXTERIORES

53383 11,50€

0,20 6 24 672  
Kg SUB ITT



300 PCS



	M4	M6	M8	M10	M12
	50 PCS	40 PCS	45 PCS	30 PCS	30 PCS
	M14	M16	M18	M20	M22
	25 PCS	25 PCS	25 PCS	15 PCS	15 PCS

## ESTOJO DE ANILHAS SEGER INTERIORES

53382 11,00€

0,15 6 24 672  
Kg SUB ITT

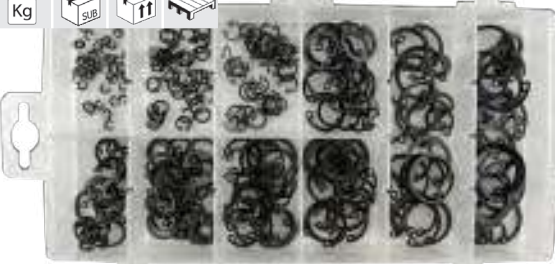

300 PCS



	M4	M6	M8	M10	M12
	50 PCS	40 PCS	45 PCS	30 PCS	30 PCS
	M14	M16	M18	M20	M22
	25 PCS	25 PCS	25 PCS	15 PCS	15 PCS

## SURTIDO DE ANILHAS DE FIBRA

53381 14,50€

0,19 6 12 384  
Kg SUB ITT



0,19 6 12 384  
Kg SUB ITT



600 PCS

	10x5.5x1	16x10x1	19x12x1	22x16x1	22.5x14x1	32x22x1
	160 PCS	80 PCS	40 PCS	30 PCS	20 PCS	20 PCS
	12x6.5x1	16x8x1	20x12.5x1	27x20x1	25.4x17.5x1	32x24x1
	100 PCS	60 PCS	40 PCS	20 PCS	15 PCS	15 PCS

## CONJUNTO DE VÁLVULAS PARA O AR CONDICIONADO

53599 30,30€

0,16 10 100 -  
Kg SUB ITT



134 PCS



5mm L: 19mm	6mm L: 19mm	7mm L: 20mm
5mm L: 19mm	6mm L: 22mm	8mm L: 22mm
5mm L: 19mm	6mm L: 26.5mm	9mm L: 22mm

### REPOSIÇÕES DISPONÍVEI

REF.	MEDIDA	Kg	u.	€/u.
14594	5x19mm R12 (VERDE)	0,01	10	2,00€
14595	5x19mm	0,01	10	1,50€
14596	5x19mm R12	0,01	10	2,00€
14597	6x19mm	0,01	10	7,60€
14598	6x26mm	0,01	10	17,80€
14599	7x20mm R134A	0,01	10	4,50€
14600	6x22mm	0,01	10	9,50€
14601	8x22mm	0,01	10	11,00€
14602	9x22mm	0,01	10	11,00€



# CAIXA DE O'RINGS

MÉTRICAS - 386 UNIDADES

TAPA DEL ESTUCHE	Posição no estôjo	006	007	008	009	010	011
	Larg. borracha (mm)	2	2	2	2	2	2
	Ø Interior (mm)	3	4	5	6	7	8
	Quantidade	16	16	16	16	16	16

TAPA DEL ESTUCHE	Posição no estôjo	113	112	111	110	012
	Larg. borracha (mm)	2.5	2.5	2.5	2.5	2
	Ø interior (mm)	14	12	11	10	10
	Quantidade	13	13	13	13	17

TAPA DEL ESTUCHE	Posição no estôjo	114	115	116	210
	Larg. borracha (mm)	2.5	2.5	2.5	3
	Ø interior (mm)	16	17	19	19
	Quantidade	13	13	13	10

BAZA TRUSEI	Posição no estôjo	222	325	326	327
	Larg. borracha (mm)	3	4	4	4
	Ø Interior (mm)	38	38	41	44
	Quantidade	12	10	9	9

BAZA TRUSEI	Posição no estôjo	221	220	219	218	217
	Larg. borracha (mm)	3	3	3	3	3
	Ø interior (mm)	36	35	33	32	30
	Quantidade	12	12	12	12	12

BAZA TRUSEI	Posição no estôjo	211	212	213	214	215	216
	Larg. borracha (mm)	3	3	3	3	3	3
	Ø interior (mm)	20	22	24	25	27	28
	Quantidade	12	12	12	12	12	12

**50651** 16,50€

0.55 5 20 360  
Kg SUB



**386**  
PCS

QUALIDADE  
HNBR

POLEGADAS - 386 UNIDADES

TAPA DEL ESTUCHE	Posição no estôjo	006	007	008	009	010	011
	Larg. borracha	1/16	1/16	1/16	1/16	1/16	1/16
	Ø interior	1/8	5/32	3/16	7/32	1/4	5/16
	Quantidade	20	20	20	20	20	20

TAPA DEL ESTUCHE	Posição no estôjo	113	112	111	110	012
	Larg. borracha	3/32	3/32	3/32	3/32	1/16
	Ø interior	9/16	1/2	7/16	3/8	3/8
	Quantidade	13	13	13	13	13

TAPA DEL ESTUCHE	Posição no estôjo	114	115	116	210
	Larg. borracha	3/32	3/32	3/32	1/8
	Ø interior	5/8	11/16	3/4	3/4
	Quantidade	13	13	13	10

BAZA TRUSEI	Posição no estôjo	222	325	326	327
	Larg. borracha	1/8	3/16	3/16	3/16
	Ø interior	11/2	11/2	15/8	13/4
	Quantidade	10	7	7	7

BAZA TRUSEI	Posição no estôjo	221	220	219	218	217
	Larg. borracha	1/8	1/8	1/8	1/8	1/8
	Ø interior	17/16	13/8	15/16	11/4	13/16
	Quantidade	10	10	10	10	10

BAZA TRUSEI	Posição no estôjo	211	212	213	214	215	216
	Larg. borracha	1/8	1/8	1/8	1/8	1/8	1/8
	Ø interior	13/16	7/8	15/16	1	11/16	11/8
	Quantidade	10	10	10	10	10	10

**50652** 16,50€

0.66 5 20 360  
Kg SUB



QUALIDADE  
HNBR

# CAIXA DE O'RINGS PARA AACC

**50807** 38,00€

0.16 6 24 672  
Kg SUB



5.29X1.78MM 20 PCS	6.07x1.78mm 20 PCS	6.8x1.9mm 20 PCS		
7.65x1.78mm 20 PCS	7.80x1.90mm 20 PCS	8.0X2.0MM 20 PCS	8.80X1.90MM 20 PCS	10.82X1.78MM 15 PCS
10.77X2.62MM 15 PCS	11.0X2.0MM 15 PCS	12.0X2.0MM 15 PCS	13.9x1.80mm 10 PCS	13.95x2.62mm 10 PCS
14.0X2.0MM 10 PCS	15.0X2.0MM 10 PCS	17.0X2.00MM 10 PCS	17.17x1.78mm 10 PCS	17.04x3.53mm 10 PCS



**270**  
PCS

# ESTOJO DE TUBOS TERMO-RETRACTÍLES

**53374** 10,00€

0.15 6 24 672  
Kg SUB



**53376** 10,50€

0.15 6 24 672  
Kg SUB

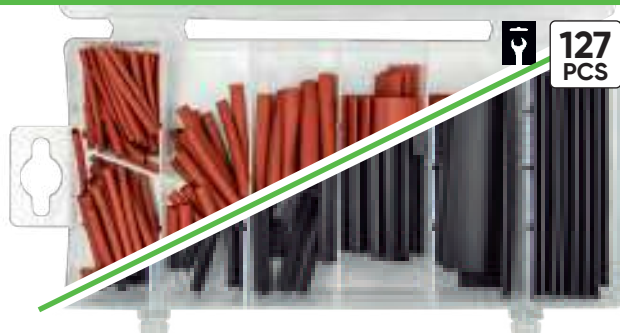

**127**  
PCS

MAÇARICO

**51920** 18,00€

0.14 10 100 400  
Kg SUB

M2x40 30 PCS	M2.5x40 25 PCS	M3.5x40 20 PCS	M5x40 20 PCS	M7x80 16 PCS	M10x80 8 PCS	M13x85 8 PCS
-----------------	-------------------	-------------------	-----------------	-----------------	-----------------	-----------------

EM PÁG. 206

**332**

**JBM** / [www.jbmcamp.com](http://www.jbmcamp.com)

IVA não incluído



# CONJUNTO DE MANGAS DE SOLDA TERMOENCOLHÍVEIS 100PCS





**53992** 18,00€

0.10 6 84 1512  
Kg SUB

- Fornece conexão rápida e fácil de cabos, solda e vedação, colocando os cabos numa manga de solda antes do tratamento térmico subsequente.  
- Material: polietileno.  
- Material do anel de solda: estanho.

**100 PCS**







 Ø1.7mm 0.25-0.34mm <sup>2</sup> 26-24 AWG 25 PCS	 Ø2.7mm 0.5-1.0mm <sup>2</sup> 22-18 AWG 35 PCS	 Ø4.7mm 1.5-2.5mm <sup>2</sup> 16-14 AWG 30 PCS	 Ø6.0mm 4.0-6.0mm <sup>2</sup> 12-10 AWG 10 PCS
--	---	--	--

# ESTOJO DE CONECTORES DE MANGUEIRA

**53910** 19,00€

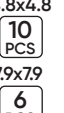
0.25 6 24 480  
Kg SUB











RETO			REDUTOR		<b>113 PCS</b>
 4.8x4.8 10 PCS	 6.3x6.3 8 PCS	 7.9x7.9 6 PCS	 9.5x9.5 6 PCS	 3.17x3.17 30 PCS	
<b>TUBO EM T</b>					
 3.9x3.9x3.9 8 PCS	 4.8x4.8x4.8 8 PCS	 6.3x6.3x6.3 6 PCS	 9.5x9.5x9.5 3 PCS	 3.17x3.17x3.17 12 PCS	

**53434** 18,00€

0.15 6 24 672  
Kg SUB



 4x28.7 10 PCS	 3.9x30.8 5 PCS	 10.4x44.4 10 PCS	 5.6x47.1 5 PCS	
 7.9x38 10 PCS	 4.7x38.9 5 PCS	 5.2x33.9 10 PCS	 7x30 10 PCS	

# ESTOJO DE BICOS PARA ENGRASSAR





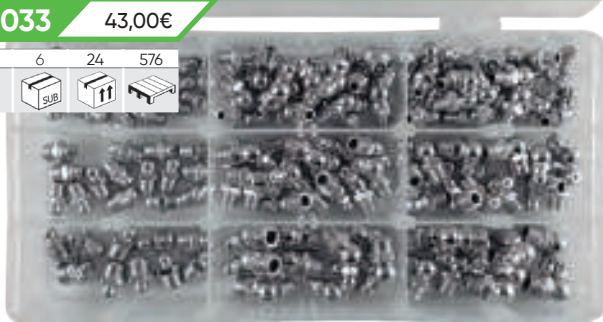



**52033** 43,00€

0.89 6 24 576  
Kg SUB



REPOSIÇÕES DISPONÍVEL

**135 PCS**

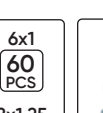





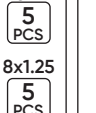

		ÂNGULO RECTO			
REF.	MEDIDA	Kg	U.	€/u.	
10868	6x1	0,01	20	0,30€	
10869	8x1	0,01	20	0,30€	
10870	10x1	0,01	10	0,45€	
		ÂNGULO 90°			
REF.	MEDIDA	Kg	U.	€/u.	
10874	6x1	0,01	20	0,30€	
10875	8x1	0,01	15	0,40€	
10876	10x1	0,01	10	0,45€	
		ÂNGULO 45°			
REF.	MEDIDA	Kg	U.	€/u.	
10871	6x1	0,01	20	0,30€	
10872	8x1	0,01	15	0,40€	
10873	10x1	0,01	10	0,45€	

# SURTIDO DE LUBRIFICADORES

**53359** 16,00€

0.49 6 24 672  
Kg SUB

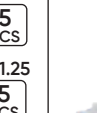

 6x1 5 PCS	 8x1.25 5 PCS	 10x1.5 5 PCS	 6x1 60 PCS	 8x1.25 10 PCS	 10x1.5 10 PCS	 6x1 5 PCS	 8x1.25 5 PCS	 10x1.5 5 PCS	
<b>ÂNGULO 90°</b>			<b>ÂNGULO RECTO</b>			<b>ÂNGULO 45°</b>			

# SURTIDO DE ABRAÇADEIRAS DE TUBO

**53378** 13,00€

0,45 6 24 672  
Kg SUB ff

	1" 4 PCS	1-1/4" 2 PCS	1-3/4" 2 PCS	2" 4 PCS
	2-1/2" 2 PCS	3" 2 PCS	3-1/2" 2 PCS	4" 2 PCS



**20 PCS**



# ESTOJO DE MOLAS

**53358** 11,50€

0,35 6 24 672  
Kg SUB ff

	9/32x1/2 10 PCS	1/4x13/32 10 PCS	7/32x11/16 10 PCS	7/32x1-1/2 10 PCS
	5/16x1-3/4 12 PCS	3/8x5/8 8 PCS	3/8x3/4 12 PCS	23/64x1-3/8 8 PCS
	13/64x13/16 10 PCS	7/32x1 10 PCS	1/4x7/8 10 PCS	5/16x1-1/8 8 PCS
	3/16x1-3/4 8 PCS	9/32x1-1/2 10 PCS	11/32x1-7/16 10 PCS	11/32x1-27/32 12 PCS
				9/32x2 12 PCS
				5/32x3-1/8 12 PCS



**200 PCS**



# KIT DE 2 PINÇAS DE CROCODILO

**53357** 7,00€

0,01 6 24 1080  
Kg SUB ff



**2 PCS**  
**30 AMP**



# ESTOJO DE FUSÍVEIS MINI

**53355** 11,50€

0,15 6 24 672  
Kg SUB ff



**120 PCS**



	5A 20 PCS	10A 20 PCS	15A 20 PCS	20A 20 PCS	25A 20 PCS	30A 20 PCS
--	-----------	------------	------------	------------	------------	------------

# ESTOJO DE FUSÍVEIS

**53356** 11,50€

0,25 6 24 672  
Kg SUB ff

REPOSIÇÕES DISPONÍVEL

REF.	MEDIDA	Kg	u.	€/u.
10915	5A	0,01	20	0,25€
10917	10A	0,01	20	0,30€
10918	15A	0,01	20	0,30€
10919	20A	0,01	20	0,30€
10920	25A	0,01	20	0,25€
10921	30A	0,01	20	0,30€

	15A 20 PCS
--	------------

	5A 20 PCS	10A 20 PCS
--	-----------	------------

	20A 20 PCS	25A 20 PCS	30A 20 PCS
--	------------	------------	------------



**120 PCS**



# ESTOJO DE FUSÍVEIS

**53367** 9,50€

0,10 6 24 1560  
Kg SUB ff



**48 PCS**

	5A 8 PCS	10A 8 PCS	15A 8 PCS		20A 8 PCS	25A 8 PCS	30A 8 PCS
--	----------	-----------	-----------	--	-----------	-----------	-----------

# ESTOJO DE FUSÍVEIS

**53368** 9,00€

0,10 6 24 1368  
Kg SUB ff

Mini fusíveis



**50 PCS**

	5A 8 PCS	10A 8 PCS	15A 8 PCS	20A 8 PCS	25A 8 PCS	30A 10 PCS
--	----------	-----------	-----------	-----------	-----------	------------



## ESTOJO DE FUSÍVEIS MINI

53380 11,50€

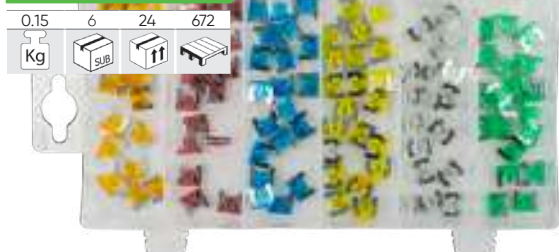

5A 20 PCS	10A 20 PCS	15A 20 PCS
20A 20 PCS	25A 20 PCS	30A 20 PCS



## ESTOJO DE FUSÍVEIS

52054 17,00€



REPOSIÇÕES DISPONÍVEI

252 PCS



MINI XXA

REF.	COLOR	POTÊNCIA	Kg	Sub	Tray	€/u.
10905	Blue	3A	0,01	20	-	0,25€
10906	Red	4A	0,01	20	-	0,25€
10907	Brown	5A	0,01	20	-	0,25€



STANDARD XXA

REF.	COLOR	POTÊNCIA	Kg	Sub	Tray	€/u.
10914	Pink	4A	0,01	20	-	0,25€
10915	Yellow	5A	0,01	20	-	0,25€
12954	Purple	3A	0,01	20	-	0,25€

3A	4A	5A	7,5A	10A	15A	20A	25A	30A
20 PCS	20 PCS	20 PCS	20 PCS	20 PCS	20 PCS	20 PCS	20 PCS	20 PCS
3A	4A	5A	7,5A	10A	15A	20A	25A	30A
8 PCS	8 PCS	8 PCS	8 PCS	8 PCS	8 PCS	8 PCS	8 PCS	8 PCS



MINI XXA

REF.	COLOR	POTÊNCIA	Kg	Sub	Tray	€/u.
10908	Yellow	7,5A	0,01	20	-	0,30€
10909	Pink	10A	0,01	20	1000	0,30€
10910	Blue	15A	0,01	20	-	0,30€



STANDARD XXA

REF.	COLOR	POTÊNCIA	Kg	Sub	Tray	€/u.
10916	Brown	7,5A	0,01	20	-	0,30€
10917	Red	10A	0,01	20	4000	0,30€
10918	Blue	15A	0,01	20	3500	0,30€



MINI XXA

REF.	COLOR	POTÊNCIA	Kg	Sub	Tray	€/u.
10911	Yellow	20A	0,01	20	1000	0,30€
10912	Grey	25A	0,01	20	-	0,25€
10913	Green	30A	0,01	20	-	0,30€



STANDARD XXA

REF.	COLOR	POTÊNCIA	Kg	Sub	Tray	€/u.
10919	Yellow	20A	0,01	20	2000	0,30€
10920	Grey	25A	0,01	20	2000	0,25€
10921	Green	30A	0,01	20	2000	0,30€

## ESTOJO DE TERMINAIS 635 PIEZAS

52053 45,00€



REPOSIÇÕES DISPONÍVEI



635 PCS



REF.	COLOR	POTÊNCIA	Kg	Sub	Tray	€/u.
10885	Red	RV1.25-4S	0,01	20	-	0,20€
10886	Blue	RV2-4S	0,01	20	-	0,20€
10887	Blue	RV2-6S	0,01	20	-	0,25€
10888	Yellow	RV5.5-6S	0,01	20	-	0,30€
10889	Yellow	RV5.5-5S	0,01	20	-	0,30€
10893	Blue	RV2-5S	0,01	20	-	0,25€



REF.	COLOR	POTÊNCIA	Kg	Sub	Tray	€/u.
10894	Red	SV1-4S	0,01	20	-	0,20€
10895	Blue	SV2-4S	0,01	20	-	0,20€



REF.	COLOR	POTÊNCIA	Kg	Sub	Tray	€/u.
10890	Yellow	BV5.5	0,01	20	-	0,35€
10891	Blue	BV2	0,01	20	-	0,25€
10892	Red	BV1.25	0,01	20	-	0,30€



REF.	COLOR	POTÊNCIA	Kg	Sub	Tray	€/u.
10896	Red	FDD1.25-250	0,01	20	2000	0,30€
10898	Blue	FDD2-250	0,01	20	1500	0,30€
10900	Yellow	FDD5.5-250	0,01	20	2000	0,30€



REF.	COLOR	POTÊNCIA	Kg	Sub	Tray	€/u.
10902	Purple	FDNF 1.25-250	0,01	20	2000	0,30€



REF.	COLOR	POTÊNCIA	Kg	Sub	Tray	€/u.
10897	Red	MDD1.25-250	0,01	20	-	0,30€
10899	Blue	MDD2-250	0,01	20	3000	0,30€
10901	Yellow	MDD5.5-250	0,01	20	-	0,25€

RV1.25-4S	RV2-4S	RV2-6S	RV5.5-6S	RV5.5-5S	BV5.5	
50 PCS	50 PCS	30 PCS	20 PCS	20 PCS	15 PCS	
BV2	BV1.25	RV2-5S	SV1-4S	SV2-4S	FDD1.25-250	
25 PCS	30 PCS	40 PCS	50 PCS	40 PCS	45 PCS	
MDD1.25-250	FDD2-250	MDD2-250	FDD5.5-250	MDD5.5-250	FDNF1.25-250	
50 PCS	40 PCS	50 PCS	25 PCS	30 PCS	25 PCS	

ALICATE PARA TERMINAIS

VEJA A PAG. 57



# SORTIDOS DE CLIPS

UNIDADES NO CASO



UNIDADES POR SACO DE PEÇAS SOBRESSALENTES



SACOS POR SUBCAIXA / CAIXA

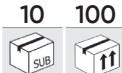

REPOSIÇÕES DISPONÍVEIS

## PARA MAZDA

52896 26,00€

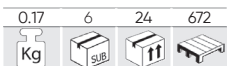

190 PCS



13110 1,85€  
OE 6508197AA



13111 1,20€  
OE B1016825200



13112 1,65€  
OE B09251833



13113 2,20€  
OE 992640543A



13114 2,20€  
OE B45556741

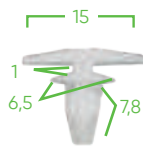

13115 2,50€  
OE G03158762



13104 1,90€  
OE 2042301

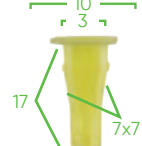

13105 2,50€  
OE 999100402

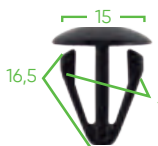

13106 2,00€  
OE B0016830200



13107 2,15€  
OE N30413356A



13108 1,90€  
OE 992640543A



13109 2,90€  
OE 99249051B



## PARA TOYOTA / LEXUS

52886 18,00€



89 PCS

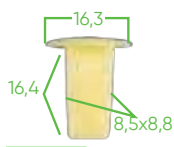

13002 1,45€  
OE 9018906001



13003 1,70€  
OE 9046707138

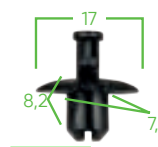

13004 1,85€  
OE 9046707117

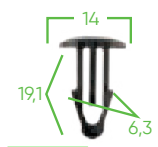

13005 1,25€  
OE 9046709138

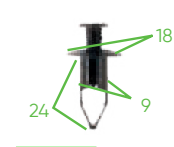

13006 1,40€  
OE 9046709101

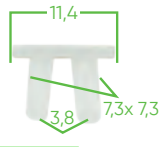

13007 1,30€  
OE 75521611000

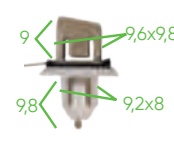

13008 2,25€  
OE 7503933060

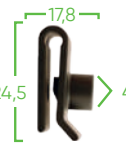

13009 1,65€  
OE 9017905060

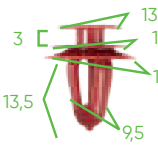

13010 1,75€  
OE 677711250

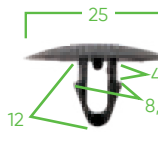

13011 1,15€  
OE 9046708124

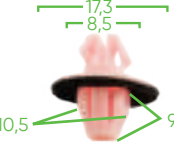

13012 1,80€  
OE 7539533030



13013 1,75€  
OE 9046711063



## PARA HONDA

52887 22,00€

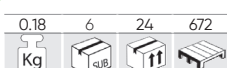

150 PCS

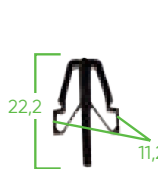

13014 1,45€  
OE 75103SJ4003

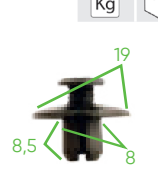

13015 1,20€  
OE 90675SB003

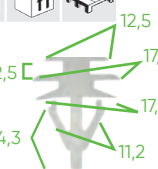

13016 1,15€  
OE 91566SP0003

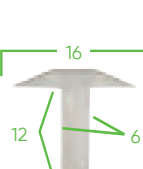

13017 2,60€  
OE 91513SE003

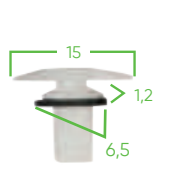

13018 1,45€  
OE 91530ST5003

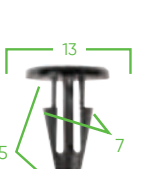

13019 1,75€  
OE 90687SA50030



13020 1,70€  
OE 91620SR2003

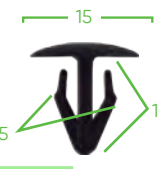

13021 1,30€  
OE 38529689A6300



13022 2,10€  
OE 90683SA5003

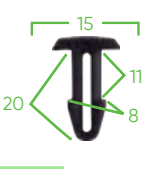

13023 1,50€  
OE 90672671003

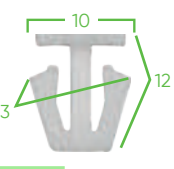

13024 2,45€  
OE 91534SE0000

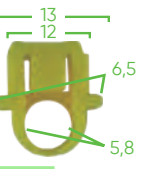

13025 1,50€  
OE 34355SD2003





# PARA PEUGEOT / CITROËN

**52899** 34,00€

0,50	6	24	336
Kg			

**345**  
PCS



 <b>13128</b> 50 50 1,85€ OE 947098	 <b>13129</b> 20 20 2,00€ OE 856535	 <b>13130</b> 20 20 3,75€ OE 6991W4	 <b>13131</b> 20 20 3,45€ OE 6991W4	 <b>13132</b> 25 25 2,65€ OE 694143	 <b>13133</b> 35 35 3,45€ OE 743707
 <b>13134</b> 30 30 3,95€ OE 7703074022	 <b>13135</b> 35 35 3,45€ OE 7703077059	 <b>13136</b> 15 15 2,60€ OE 698317	 <b>13137</b> 25 25 2,25€ OE 699502	 <b>13138</b> 30 30 2,85€ OE 6995X3	 <b>13139</b> 40 40 3,85€ OE 69945

# PARA FIAT

**52900** 34,00€

0,50	6	24	336
Kg			

**308**  
PCS



 <b>13140</b> 30 30 2,65€ OE 14591784	 <b>13141</b> 20 10 1,80€ OE 1459487	 <b>13142</b> 25 25 3,10€ OE 1300433650	 <b>13143</b> 8 8 1,95€ OE 71717421	 <b>13144</b> 25 25 2,20€ OE 82456515	 <b>13145</b> 25 25 3,85€ OE 5751139
 <b>13146</b> 20 8 4,50€ OE 46306526	 <b>13147</b> 25 25 3,10€ OE 14591687	 <b>13148</b> 25 25 3,30€ OE 14591687	 <b>13149</b> 25 25 3,10€ OE 14592387	 <b>13150</b> 30 30 2,25€ OE 83468473	 <b>13151</b> 50 50 5,35€ OE 7677865

# PARA VOLVO

**52901** 34,00€

0,48	6	24	216
Kg			

**350**  
PCS



 <b>13152</b> 25 25 3,05€ OE 8099905N07	 <b>13153</b> 30 30 3,10€ OE 4292906	 <b>13154</b> 20 20 3,20€ OE 12681763	 <b>13155</b> 40 40 5,60€ OE 51131804205	 <b>13156</b> 40 40 3,30€ OE 947098	 <b>13157</b> 40 40 3,85€ OE 591740
 <b>13158</b> 25 25 3,75€ OE 6384801G00	 <b>13159</b> 20 20 3,20€ OE 9133417	 <b>13160</b> 40 40 5,00€ OE 9133073	 <b>13161</b> 30 30 3,55€ OE 3272075327462B	 <b>13162</b> 20 20 2,60€ OE 327462A	 <b>13163</b> 20 20 2,80€ OE 3923712

# SORTIDOS DE CLIPS

## PARA VOLSKWAGEN

52889 19,00€

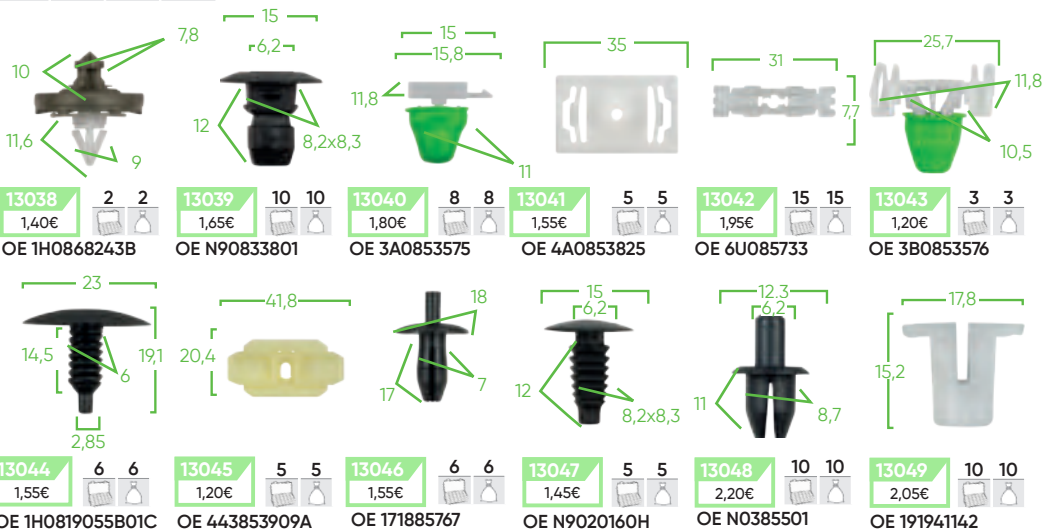
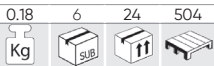

85  
PCS



## PARA BMW

52892 22,00€

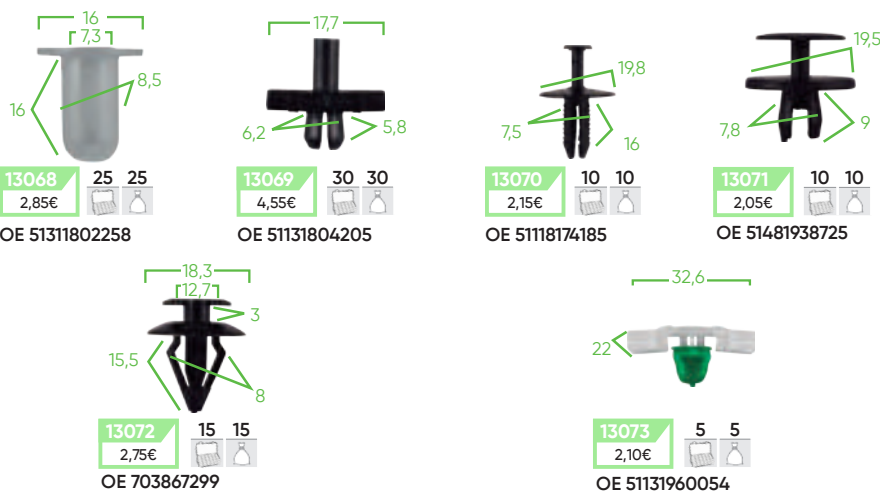
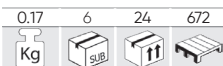

95  
PCS



## PARA NISSAN

52894 22,00€

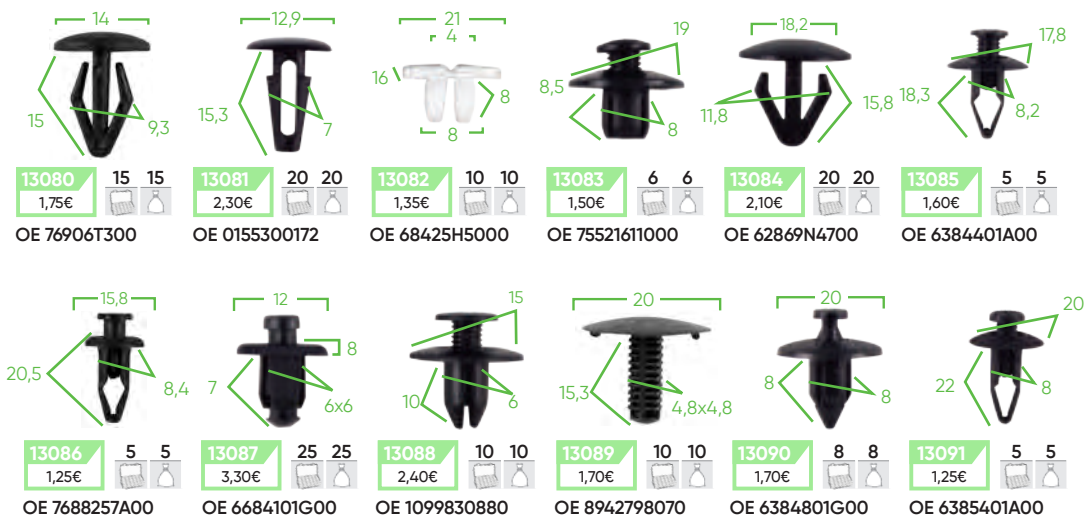
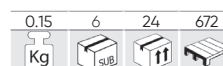

139  
PCS





# SORTIDOS DE CLIPS

UNIDADES NO CASO



UNIDADES POR SACO DE PEÇAS SOBRESSELENTES



SACOS POR SUBCAIXA / CAIXA

10

100



REPOSIÇÕES DISPONÍVEI

## PARA AUDI

52890 22,00€

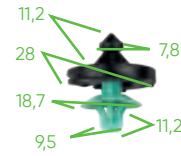
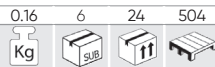

13052 3 3  
1,25€

OE 1H0868243B

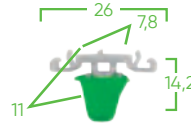

13054 5 5  
2,35€

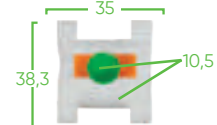

13055 3 3  
3,00€

OE 3A0853575

31 PCS

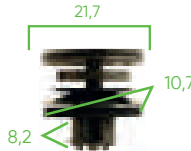

13050 5 5  
1,55€

OE 3B0868243



13051 5 5  
1,50€

OE 1H0867199A

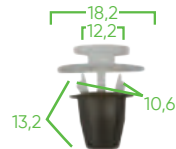

13053 10 10  
2,80€

OE 357853575

## PARA FORD

52891 28,00€

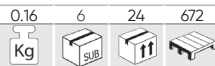

13056 8 8  
1,55€

OE 388577S

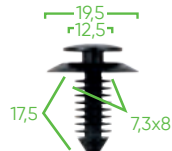

13057 5 5  
1,50€

OE N801925S



13058 20 20  
2,20€

OE N806289S

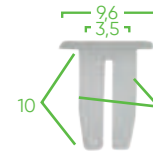

13059 20 20  
2,35€

OE N379830S

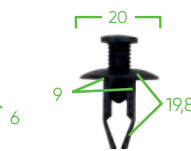

13060 5 5  
1,60€

OE 1007932



13061 20 20  
2,65€

OE 16500308

169 PCS

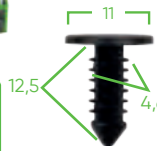

13062 20 20  
2,35€

OE N803170S

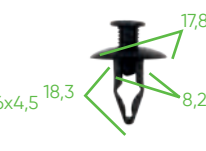

13063 6 6  
1,15€

OE W706713S300

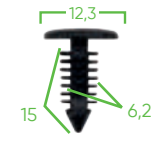

13064 20 20  
2,60€

OE N388246S

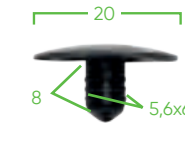

13065 15 15  
2,00€

OE F22Z16774A

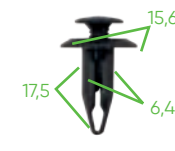

13066 5 5  
2,25€

OE 1673046

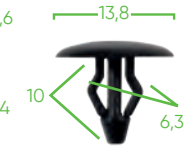

13067 25 25  
2,55€

OE FICZ16674A

## PARA BENZ

52893 26,00€

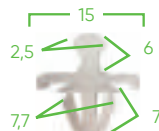
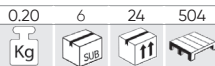

13074 30 30  
4,65€

OE A0019884481



13075 20 20  
5,35€

OE A0019882981



13076 15 15  
3,90€

OE A1249900492



13077 4 4  
2,55€

OE A0019888081

95 PCS

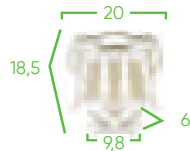

13078 6 6  
2,55€

OE A1249880492

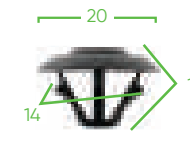

13079 20 20  
3,35€

OE A0019880325

# SORTIDOS DE CLIPS

## PARA RENAULT

52897 38,00€

0,43	6	24	336
Kg	Sub	11	



13116 50 50  
5,45€

OE 7703077421

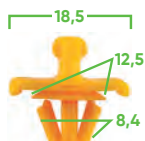

13117 50 50  
3,65€

OE 7703074022



13118 60 60  
15,90€

OE 7703081184

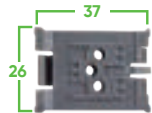

13119 15 15  
5,60€



13120 60 60  
5,50€

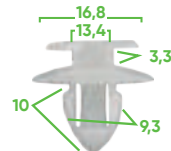

13121 65 65  
8,75€

OE 7703077059

300  
PCS



## PARA MITSUBISHI

52895 22,00€

0,19	6	24	1500
Kg	Sub	11	

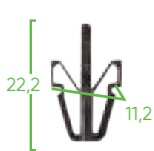

13092 15 15  
1,65€

OE 8942180270

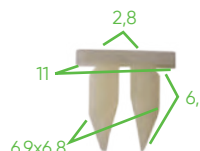

13093 30 30  
2,95€

OE 9018905013

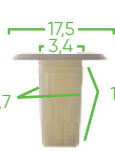

13094 10 10  
1,50€

OE MU480033



13095 8 6  
1,20€

OE 128100231



13096 8 8  
1,70€

OE MU480034



13097 3 3  
1,20€

OE MR138807

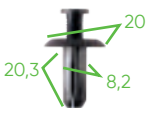

13098 4 4  
1,65€

OE MB253964

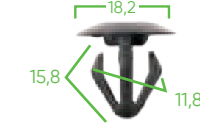

13099 30 30  
2,75€

OE HB121467



13100 3 3  
1,20€

OE MB271999



13101 8 8  
1,50€

OE MB696120

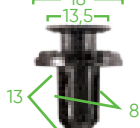

13102 5 5  
1,60€

OE MR200300

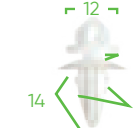

13103 10 10  
1,80€

OE MB846992

132  
PCS



## PARA VAUXHALL / OPEL

52898 36,00€

0,45	6	24	360
Kg	Sub	11	



13122 20 20  
1,95€

OE 90218614

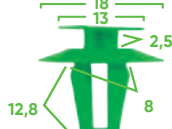

13123 40 40  
5,35€

OE 174864



13124 100 100  
8,20€

OE N0385501

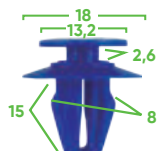

13125 50 50  
5,95€

OE 2345959



13126 50 50  
1,55€

OE 2240582



13127 40 40  
5,60€

OE 180942

300  
PCS





# SORTIDOS DE CLIPS





## UNIVERSAL

52888 24,00€

0,17 6 24 672  
Kg SUB 11 1

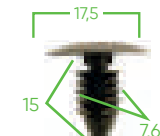
128 PCS

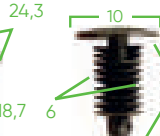
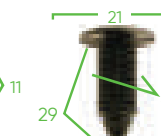
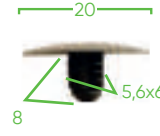
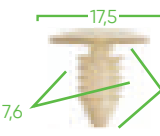
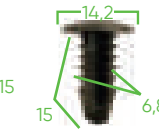

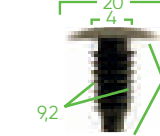
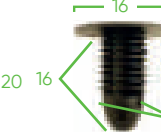
 17,5 17 7,5 <b>13026</b> 8 8 1,55€ OE 388577S	 17,5 15 7,6 7,7x7,8 <b>13027</b> 10 10 1,85€ GENERAL USE	 24,3 18,7 7,7x7,8 <b>13028</b> 6 6 1,45€ OE 6003423	 24,3 18,7 7,7x7,8 <b>13029</b> 6 6 1,65€ VW: N989022 CHRYSLER: 6003349 FORD: 385661	 10 11 6 <b>13030</b> 25 25 2,80€ GM: 20699808 CHRYSLER: 6502328	 21 18 11,5 29 <b>13031</b> 4 4 1,85€ FORD: N804379S
 20 8 5,6x6 <b>13032</b> 15 15 2,00€ MAZDA: 6508197AA FORD: F22Z16774A	 17,5 15 7,6 <b>13033</b> 10 10 1,60€ GM: 16674629 FORD: N8061135	 14,2 15 6,8 <b>13034</b> 20 20 2,65€ NISSAN: 0153301781	 17,6 25 7,5 <b>13035</b> 6 6 1,65€ GM: 10124502 BMW: 52201964201 LAND ROVER: DZM100080	 20 4 20 9,2 <b>13036</b> 6 6 1,40€ VW: N9020160H FORD: 6998849 BMW: 51471904317 OPEL: 2207713	 16 16 7x7 <b>13037</b> 12 12 2,10€ GENERAL USE





## PARA TAPÉÇARIA BMW MINI

53720 19,00€

0,20 6 24 672  
Kg SUB 11 1

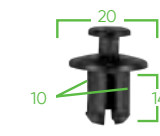
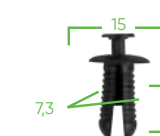
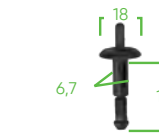
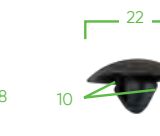
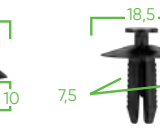
112 PCS

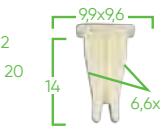

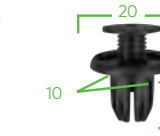
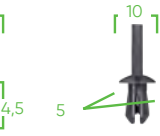
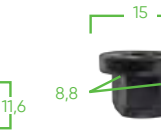
 20 10 14 <b>14447</b> 7 6 1,45€ OE 51471911992	 15 7,3 15 <b>14449</b> 13 10 2,20€ OE A0009905492	 18 6,7 17,8 <b>14471</b> 5 5 1,90€ OE 51717002953	 22 10 10 <b>14472</b> 5 5 1,35€ OE 51489119216	 18,5 7,5 16 <b>14474</b> 8 8 1,50€ OE 51118174185	 24 5 10 <b>14475</b> 6 6 1,65€ OE 2019900050
 12 11,5 20 7,2 <b>14476</b> 9 9 2,05€ OE 51481915964	 9,9x9,6 14 6,6x7,2 <b>14477</b> 15 15 2,45€ OE 0009881625	 7x6,7 14 <b>14478</b> 15 15 4,05€ OE 7146976114	 20 10 14,5 <b>14479</b> 6 6 1,65€ OE 91503SP0003	 10 5 11,6 <b>14480</b> 15 15 2,05€	 15 8,8 8 <b>14481</b> 8 8 1,70€ OE 51161943122

## PARA PAINÉIS DE PORTAS/MOLDURAS BMW MINI

53719 19,00€

0,15 6 24 672  
Kg SUB 11 1

92 PCS

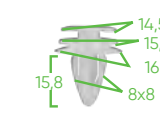
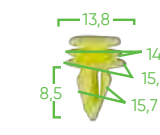
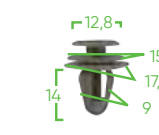
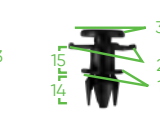
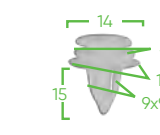
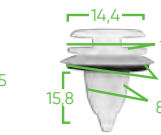
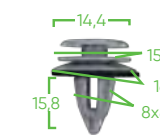
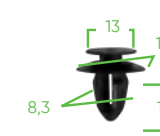
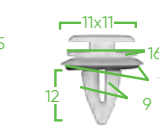
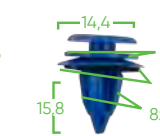
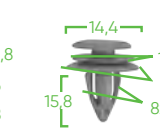
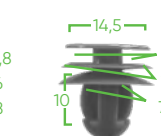

 14,5 15,8 16 15,8 8x8 <b>14359</b> 8 4 1,05€ OE 51418224768	 13,8 14,4 15,5 15,7 8,5 <b>14458</b> 8 8 1,70€	 12,8 15,3 17,4 9 14 <b>14459</b> 6 6 1,45€	 30 15 22 14 15 14 <b>14460</b> 2 2 1,15€ OE 7147122912	 14 15 17,5 9x9 <b>14461</b> 8 8 1,35€ OE 51411973500	 14,4 15,8 16 8x8 <b>14462</b> 8 8 1,65€
 14,4 15,8 16 8x8 15,8 <b>14463</b> 8 8 1,65€	 13 17,5 13 8,3 <b>14464</b> 10 10 1,50€ OE 611769	 11x11 16,5 17 9 12 <b>14465</b> 10 10 2,00€ OE 7147145753	 14,4 15,8 16 8x8 15,8 <b>14466</b> 8 8 1,65€	 14,4 15,8 16 8x8 15,8 <b>14468</b> 8 8 1,30€	 14,5 16 17,5 7,7 10 <b>14469</b> 8 8 1,45€ OE 7147133419

# SORTIDOS DE CLIPS

UNIDADES NO CASO



UNIDADES POR SACO DE PEÇAS SOBRESSALENTES



SACOS POR SUBCAIXA / CAIXA

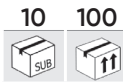









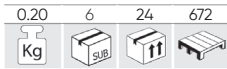

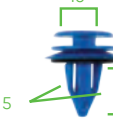

REPOSIÇÕES DISPONÍVEIS

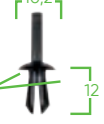

## PARA TAPEÇARIA MERCEDES-BENZ

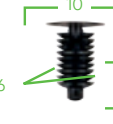
**53718** 19,00€

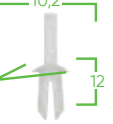

 14422 6 6 1,50€ OE A0009913940	 14446 20 20 2,80€ OE 9903492	 14447 6 6 1,45€ OE 51471911992	 14448 12 12 2,05€ OE N105835019B9	 14449 10 10 2,20€ OE A0009905492	 14450 12 12 2,15€ OE N0385012
 14451 12 12 2,15€ OE A1239900092	 14452 25 25 2,55€	 14453 20 20 3,05€	 14455 12 12 2,10€	 14456 6 6 1,35€	 14457 10 10 1,70€ OE A1249900492



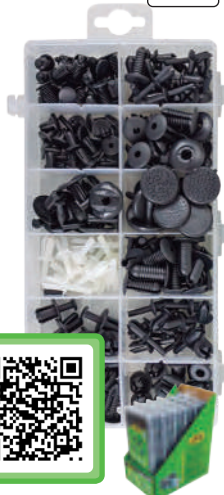



151 PCS

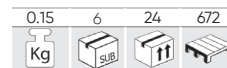

## PARA PAINÉIS DE PORTAS/MOLDURAS MERCEDES-BENZ

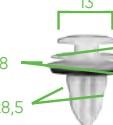
**53717** 19,00€

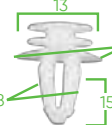
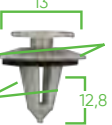
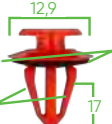

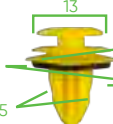
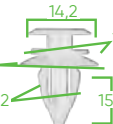
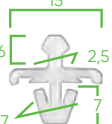
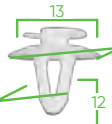
 14434 8 8 1,60€	 14435 6 6 1,45€	 14436 8 8 1,70€ OE A0009910198	 14437 6 6 1,45€ OE A0019912698	 14438 8 8 1,35€ OE A0089880978	 14439 8 8 1,75€ OE 0069884378
 14440 8 8 1,75€	 14441 10 10 1,65€ OE 0019884981	 14442 6 6 1,45€	 14443 8 8 1,45€	 14444 10 10 1,90€ OE 0019886081	 14445 10 10 1,45€

96 PCS



## PARA PAINÉIS DE PORTA/MOLDURAS/TAPEÇARIA VAG/SEAT/SKODA

**53716** 19,00€



 14422 6 6 1,50€ OE A0009913940	 14423 15 15 3,55€ OE 6E0837732	 14424 7 7 1,85€	 14425 2 2 2,05€ OE 6Q0868243	 14426 8 8 1,90€ OE 171201969	 14427 8 4 1,20€ OE 4D0807300
 14428 12 12 1,40€ OE 251823717	 14429 6 6 1,80€	 14430 3 3 2,25€ OE 8E0821989A	 14431 2 2 1,45€ OE 3B0868243	 14432 10 10 1,45€ OE 1H0823717	

79 PCS





# SORTIDOS DE CLIPS

## PARA TAPEÇARIA PEUGEOT/CITROËN

**53715** 19,00€

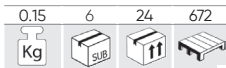

**110 PCS**



**14410** 10 10  
1,85€



**14411** 10 5  
1,70€



**14412** 10 10  
1,70€



**14413** 10 10  
3,25€



**14414** 10 10  
1,70€  
OE 2346824



**14415** 10 10  
1,70€  
OE A1249900492

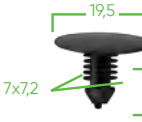

**14416** 10 5  
1,25€  
OE 6992C6



**14419** 15 15  
1,95€



**14420** 15 15  
1,50€



**14421** 10 10  
2,45€  
OE 14093311

## PARA PAINÉIS DE PORTA PEUGEOT/CITROËN

**53713** 16,00€

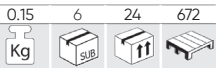

**93 PCS**



**14350** 6 6  
1,80€  
OE 6991Y8

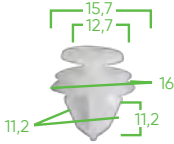

**14358** 10 10  
1,70€  
PEUGEOT: 6991Y8  
CITROËN: 6991Y8  
FIAT: 9654280780  
RENAULT: 7703077469

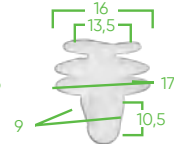

**14387** 8 8  
1,45€



**14388** 8 8  
2,05€  
OE 7703077250



**14389** 6 6  
1,25€  
OE 6995A3

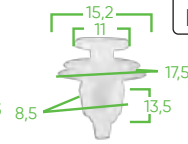

**14390** 6 6  
1,35€



**14391** 15 15  
2,15€

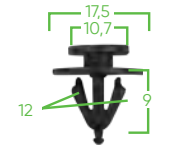

**14392** 6 6  
1,35€

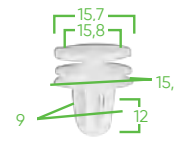

**14393** 8 8  
1,50€

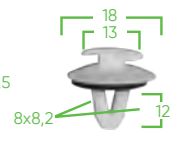

**14395** 8 8  
1,65€

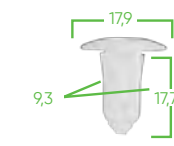

**14396** 6 6  
1,20€

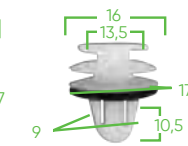

**14397** 6 6  
1,45€

## PARA MOLDURAS PEUGEOT/CITROËN

**53714** 16,00€

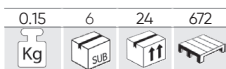

**80 PCS**

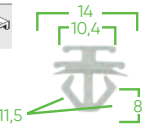

**14398** 8 8  
1,30€  
OE 6995X3

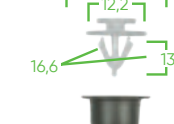

**14399** 6 6  
1,90€  
OE 129943

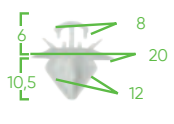

**14402** 8 8  
1,50€  
OE 856548

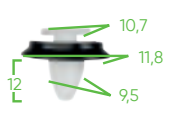

**14404** 8 8  
2,10€  
OE 71728806



**14405** 16 8  
1,45€  
OE 968865987703

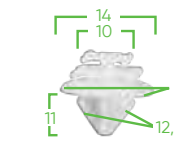

**14406** 10 10  
1,55€  
OE 856540



**14408** 10 10  
1,45€  
OE 856534

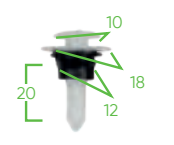

**14409** 8 8  
1,35€  
OE 357853586

## ALICATE PARA EXTRAÇÃO DE GRAMPOS DE CARROCERIA

**53385** 19,30€



IVA não incluído

## JOGO 2 PALANÇAS EXTRAIR PEÇAS DE AUTOMÓVEL

**52851** 9,65€

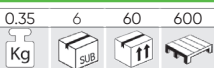

**JBM** / [www.jbmcamp.com](http://www.jbmcamp.com)

## JOGO DE 6 PALANÇAS

**53110** 27,30€



**6 PCS**

5"x8.5 / 5"x10.3  
5"x4.5 / 15"x8.5  
15"x10.3 / 15"x4.5mm



## PARA TAPEÇARIA RENAULT / DACIA

**53712** 16,00€

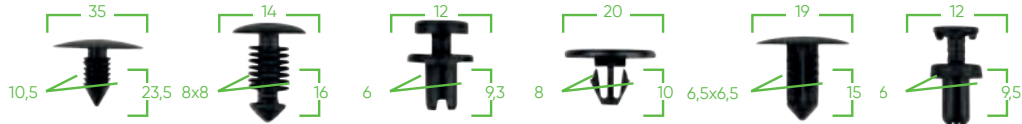
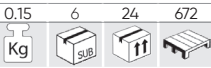

**14374** 3 3 1,70€  
 OE 7703077435  
**14375** 15 15 1,85€  
 OE 7L6868307  
**14376** 20 20 2,60€  
 OE 7703077117  
**14377** 10 10 1,90€  
**14378** 12 12 1,90€  
**14379** 6 6 1,45€



**14381** 10 10 1,70€  
 OE 7703072360  
**14383** 6 6 1,35€  
 OE 7703077153  
**14382** 10 10 1,85€  
 OE W705956S300  
**14384** 12 12 2,10€  
**14416** 5 5 1,25€  
 OE 6992C6



**109**  
PCS

## PARA MOLDURAS RENAULT / DACIA

**53711** 16,00€

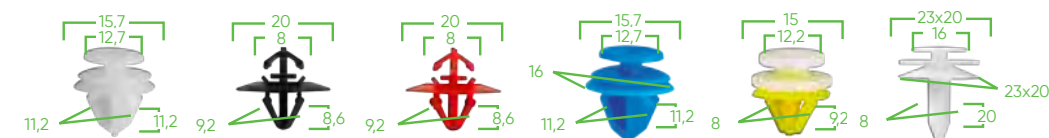
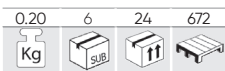

**14358** 10 10 1,70€  
 PEUGEOT: 6991Y8  
 CITROËN: 6991Y8  
 FIAT: 9654280780  
 RENAULT: 703077469  
**14364** 10 10 1,90€  
 OPEL: 7701470779  
 NISSAN: 7703077421  
 RENAULT: 7703077421  
**14365** 10 10 1,90€  
 OPEL: 7701470779  
 NISSAN: 7703077421  
 RENAULT: 7703077421  
 IVECO: 500326896  
**14366** 8 8 1,45€  
 RENAULT: 7703077368  
 OPEL: 4430858  
**14356** 12 10 1,90€  
**14367** 3 3 1,30€  
 OE 7L5853994



**14368** 8 8 1,45€  
**14369** 15 15 4,95€  
**14371** 3 3 3,00€  
 PEUGEOT: 6991Y8  
 CITROËN: 6991Y8  
 FIAT: 9654280780  
 RENAULT: 703077469  
**14370** 3 3 3,00€  
**14372** 4 4 1,20€  
 OE 7701061797  
**14373** 4 4 1,35€



**90**  
PCS

## PARA PAINÉIS DE PORTA RENAULT / DACIA

**53710** 16,00€

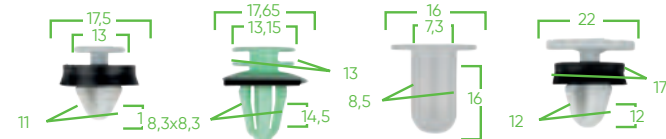
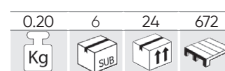

**14350** 12 6 1,80€  
 OE 6991Y8  
**14351** 8 8 1,65€  
**14352** 7 7 1,30€  
 OE 51447780135  
**14353** 8 4 2,10€  
 OE 7703077476

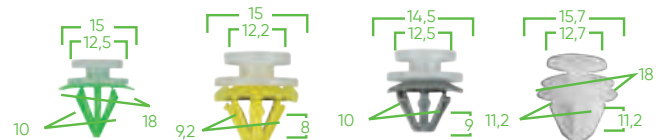

**14355** 8 8 1,70€  
 OE 7703077354  
**14356** 10 10 1,90€  
 OPEL: 4430858  
 RENAULT: 7703077368  
**14357** 10 10 1,90€  
 OE 7703077430  
**14358** 10 10 1,70€  
 OE 51418224768

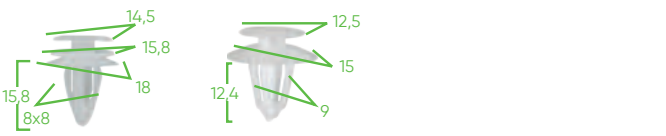

**14359** 4 4 1,05€  
**14368** 8 8 1,45€  
 PEUGEOT: 6991Y8  
 CITROËN: 6991Y8  
 FIAT: 9654280780  
 RENAULT: 7703077469



**85**  
PCS

## PÔSTER DE CLIPES

**15001** 3,00€

- Pôster informativo dos cliques plásticos JBM. Com todas as informações de cada clipe (referência, preço, quantidades e medidas).



330x1000mm





# **ROUPA**

346 COLETE  
JAQUETA



## COLETE JBM

Tamanho L

**70002** 37,50€

0.40 - 5 200



Tamanho XL

**70013** 44,00€

0.30 - 10 240



Tamanho L

**70015** 44,00€

0.30 - 10 240



Tamanho XL

**70003** 37,50€

0.40 - 5 200



Tamanho M

**70014** 44,00€

0.30 - 10 240



Tamanho XL

**70016** 44,00€

0.35 - 10 240



Tamanho S

**70009** 37,50€

0.40 - 5 180



Tamanho XXL

**70017** 44,00€

0.35 - 10 240



70002, 70003



2 BOLSOS INTERIORES DE GRANDE CAPACIDADE

70007, 70009



2 BOLSOS LATERAIS

70013, 70014, 70015, 70016, 70017



Resistente ao frio

Térmica

Leve

## JAQUETA JBM

Tamanho L

**70005** 42,00€

0.70 - 5 140



**70011** 42,00€

0.60 - 5 120



Tamanho XL

**70012** 42,00€

0.70 - 5 120



GOLA ALTA E COM FECHO NA FRENTE



TRÊS BOLSOS EXTERIORES



Resistente ao frio

Térmica

Leve



490mm

CABIDE

**13929** 3,45€

0.10 - - 280



EXPOSITOR

**METEXP** 62,00€

6.00 - 1 25







## **PROMOTIONALS**

348 DISPOSITIVOS ELETRÔNICOS JBM  
352 PROMOTIONALS  
354 EXPOSITORES E ACESSÓRIOS  
EMBALAGEM

## CÂMARA ESPORTIVA

53865 48,00€

0,30 - 36 432



- ✓ **Corpo à prova d'água** que permite fotografar em profundidades de até 30 metros.
- ✓ **Display LCD** de alta resolução baseado na tecnologia **LTPS**.
- ✓ Bateria removível que é fácil de substituir.
- ✓ Gravação de vídeo digital, fotografia, exibição de vídeo e gravação de áudio.
- ✓ **Lente grande angular HD de 120° HD**.
- ✓ **Webcam**.
- ✓ Suporta cartões de memória de até **64GB**.
- ✓ **Suporta vários formatos** de gravação de vídeo.
- ✓ **Deteção de movimento e gravação em loop**.



GRAVAÇÃO DE ALTA DEFINIÇÃO

### PROJETADO PARA:

- Gravação de veículos
- Segurança residencial
- Fotografia
- Esportes ao ar livre
- Gravação em águas profundas
- Etc.



### ACESSÓRIOS:



## CADEIRA GIRATÓRIA

53956 353,00€

21,50 - 1 4



- ✓ **Material:** PU
- ✓ **Espessura da estrutura de aço:** 1,2cm
- ✓ **Assento:** espuma moldada
- ✓ **Encosto:** espuma de poliuretano
- ✓ **Apoio de braço:** 2D
- ✓ **Elevador a gás:** Classe 3
- ✓ **Base de nylon:** 350mm

ALMOFADA DE ENCOSTO DE CABEÇA

DIMENSÕES 70X55X126-136CM

200Kg



ALMOFADA LOMBAR

ALTURA AJUSTÁVEL

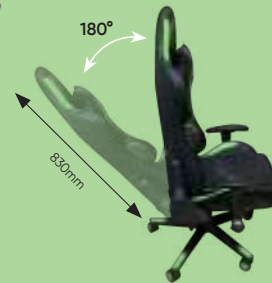

BASE PARA CADEIRA ROTATIVA

15256 1,85  
36,00€ Kg

APOIO DE BRAÇO DIREITO

15257 1,35  
27,50€ Kg

APOIO DE BRAÇO ESQUERDO

15258 1,35  
27,50€ Kg

AMORTECEDOR

15259 0,85  
18,00€ Kg

CONJUNTO DE 5 ROLOS

15260 0,60  
22,50€ Kg

## CARPA STAND JBM 3x3m

53973 284,00€

18,40 - 1 31

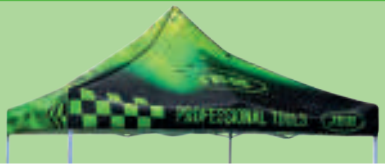

### LATERAL PARA REF. 53973

15152 160,00€

2,25 - 5 -



- Consiste em duas partes:
- Parte lateral que cobre 3/4 partes da barraca.
  - Parte frontal que cobre 1/4 parte da barraca. Com zíper vertical como porta



INCLUI COBERTURA PROTETORA DO SUPORTE JBM

14347 36,50€

0,60 - 5 -

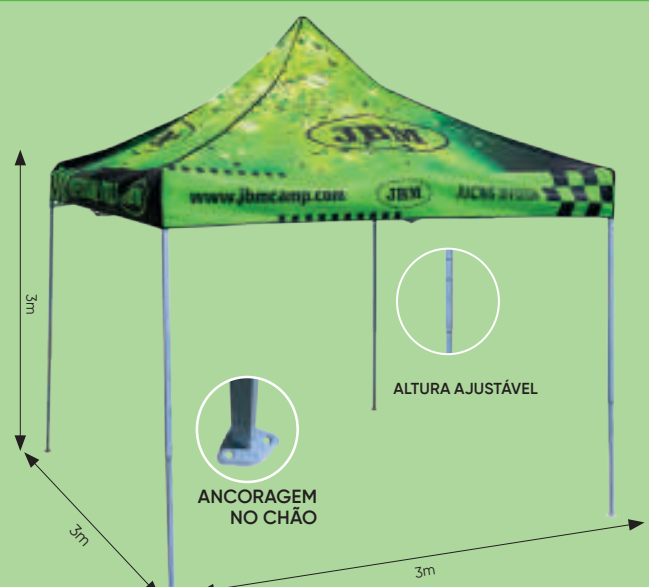

ALTURA AJUSTÁVEL

ANCORAGEM NO CHÃO



# ROBÔ ASPIRADOR

**54020** 288,00€



O robô inteligente realiza **limpeza e lavagem automaticamente**. Graças ao seu sistema de orientação espacial inteligente, ele pode limpar completamente a área de trabalho. É possível uma configuração flexível com seleção do modo de operação, com ajuste do nível de sucção e umidade e agendamento das tarefas para um horário específico.

4-5H 100-180min 14.8V 2600mAh

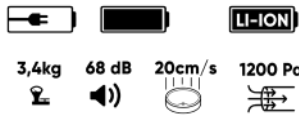

**20W**

ESCOVA LATERAL ESQUERDA

**15340**  
5,50€



ESCOVA LATERAL DIREITA

**15341**  
5,50€

ESCOVA PRINCIPAL

**15342**  
9,00€

FILTRO HEPA

**15343**  
9,50€

FERRAMENTA DE LIMPEZA

**15344**  
6,50€

CONJUNTO DE 5 ESFREGÕES

**15345**  
10,50€

CONEXÃO DE APP



ESTACION BASE

**15346**  
24,00€

TOMA DE CORRENTE

**15349**  
8,50€

Máxima superfície cubierta  
Maximum covered area  
**120m<sup>2</sup>**

Capacidade tanque de água  
Water tank capacity  
**300ml**

Capacidade del depósito de polvo  
Dust box capacity  
**300ml**

# MOCHILA JBM

**54043** 48,00€



✓ **Miejsce do przechowywania i kieszenie:** Dwie komory umożliwiają przechowywanie m.in. laptopy do 17,3 cala oraz tablety.

✓ **Material:** Poliuretan; wodoodporny, wytrzymały i solidny plecak.

✓ **Lekki i wygodny:** Wygodne, oddychające plecy z siatki i ramiączka wykonane z gąbki.



# CAMISA POLO JBM

REF.	TALLA	Kg	sub	ff	€
13243	M	0,25	100	600	12,50€
13244	L	0,26	100	600	12,50€
13245	XL	0,28	100	600	12,50€



# BOLSA JBM

**13968** 1,35€

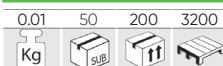

# CANECA JBM

**54076** 9,00€



## PEN 4 CORES PROMOCIONAL JBM

53533 1,50€

0.01	50	1000	12000
Kg	Sub	ff	ff



- Caneta de 4 cores: azul, vermelho, preto, verde.

COM PONTEIRO TRASEIRO DE BORRACHA PARA ESCREVER EM TELAS SENSÍVEIS AO TOQUE



## EXPOSITOR DIGITAL DO DISTRIBUIDOR JBM

15789 2.545,00€

40.50	-	1	6
Kg	Sub	ff	ff

A tela promocional da JBM é o futuro da publicidade para o seu negócio. Com o seu tamanho LCD de 43" e tecnologia LED, será o centro das atenções em qualquer loja. Eles são projetados para impactar. Imagens e vídeos em constante mudança que criam um efeito garantido de atração no público. Ao contrário da publicidade convencional em outdoors, letreiros, etc., a publicidade em telas de LED é muito mais dinâmica. Essas características fazem da tela promocional JBM um produto altamente lucrativo que trará grandes benefícios para sua loja.



## FRITADEIRA ELÉTRICA AIRFRYER

54171 138,00€

4.90	-	2	18
Kg	Sub	ff	ff



3,5L	≤65dB	220V 240V	1500W
80°C 200°C	360°	0-60'	



## BICICLETA ESTÁTICA

53930 276,00€

29.00	-	1	5
Kg	Sub	ff	ff

- Tempo: 0: 00~99:59 min
- Distância: 0,00~9999 milhas (km)
- Distância total: 0,00~9999 milhas (km)
- Velocidade: 0,0~9999
- Calorias: 0,0~9999 kcal
- Pulso: 40~240 bpm
- Bateria: AAA, 2 unid.
- Temperatura de operação: 0 ~ 40°C (32~104°F)
- Temperatura de armazenamento: 10 ~ 60°C (14~168°F)



ASSENTO CONFORTÁVEL



RODAS PARA TRANSPORTE



AJUSTE DE ESFORÇO



ALÇA CONVENIENTE



- FUNÇÕES DE MEDIÇÃO:
- TEMPO
  - RAPIDEZ
  - DISTÂNCIA
  - CALORIAS
  - DISTÂNCIA TOTAL
  - PULSO
  - VARREDURA

350



## TROTINETE DE 2 RODAS - SCOOTER PASSADEIRA

**53504** 38,00€

3.50 - 6 36  
Kg SUB ff

77mm 100mm



**53934** 690,00€

0.25 10 40 1480  
Kg SUB ff

-Tensão de alimentação: 220 V - 240 V  
- Frequência da rede: 50 - 60 Hz  
- Potência nominal: 550 W  
- Máx. potência: 1500 W (2,0 HP)  
- Velocidade: 1,0 - 12 níveis (velocidade máxima de 9,5 km/h)  
- Tamanho dobrado: 970\*675\*1275 mm  
- Tamanho da trilha: 400\*1100 mm  
- Visor: 3,5", luz de fundo azul



1160mm 1450mm 675mm

110 KG

### FUNÇÃO REPRESENTAÇÃO:

- TEMPO
- DISTÂNCIA
- VELOCIDADE
- CALORIAS
- PULSO



## CHURRASQUEIRA BBQ

**53931** 104,00€

6.10 - 1 18  
Kg SUB ff



- Material: ferro e fios
- Espessura: 0,4 mm
- Revestimento: tampa - pó preto, tigela - porcelana preta
- Grelha de cozimento: 43x40 cm, cromo
- Grelha de carvão: 36x36 cm, galvanizada
- Altura de trabalho durante o cozimento: 59 cm
- Pernas: 430 de aço inoxidável, 19 mm de diâmetro



UMA GRELHA DE COZIMENTO, UMA GRELHA DE CARVÃO E UMA GRELHA DE AQUECIMENTO

### ABERTURA NA TAMPA



REVESTIMENTO: TAMPA - PÓ PRETO, TIGELA - PORCELANA PRETA

810mm 450mm

### PRATELEIRA LATERAL, 2 RODAS, ALÇA E TIGELA



PERNAS DE AÇO INOXIDÁVEL

## SUPORE DE PRESUNTO

**14975** 64,00€

2.95 - 4 80  
Kg SUB ff

- Dimensões: 500x330x440mm
- Peso: 2,18 kg



## CONJUNTO DE 3 FACAS

**53511** 23,00€

0.65 5 20 360  
Kg SUB ff



3 PCS

## BOLSA REFRIGERADA JBM

**53949** 4,50€

0.10 - 15 540  
Kg SUB ff

350mm 675mm 675mm



**53950** 4,50€

0.10 - 15 630  
Kg SUB ff

## CONJUNTO DE 24 TALHERES

**53512** 41,00€

1.90 - 12 144  
Kg SUB ff



24 PCS

## GUARDA-CHUVA PROMOCIONAL JBM

**52857** 7,50€

0.31 10 60 600  
Kg SUB ff

84mm



## COLAR DE PÉROLAS

**53513** 9,00€

0.05 9 495 5940  
Kg SUB ff



## CONJUNTO DE 2 TOALHAS

**53510** 24,00€

0.65 - 25 100  
Kg SUB ff



2 PCS

IVA não incluído

**JBM** / [www.jbmcamp.com](http://www.jbmcamp.com)

351

# EXPOSITOR DE FERRAMENTAS VAZIO

**53877** 430,50€

42,00	-	1	-
Kg	Sub	Up	Box

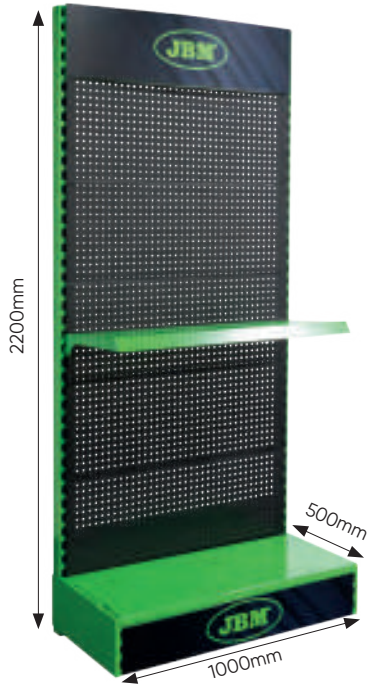

## CONTÉM

**14945** x1



**11318** x20



**14380** x1

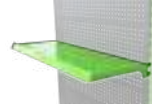

**14946** x1



# PEÇAS DE EXPOSITOR

**14946** 58,00€

CABEÇAL PARA EXPOSITOR DE FERRAMENTAS

3,40	-	1	48
Kg	Sub	Up	Box

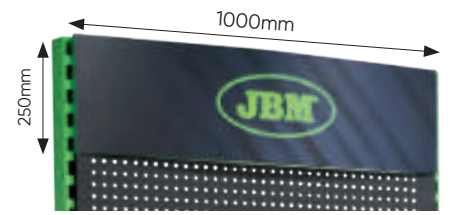

**14947** 201,50€

SUPORTE LEVE DE ESTANTE DE FERRAMENTAS

8,55	-	1	6
Kg	Sub	Up	Box

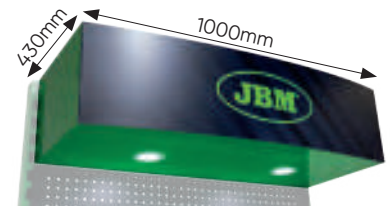

**14380** 51,00€

BANDEJA DE SUPORTE DE FERRAMENTAS 53877

5,00	-	1	27
Kg	Sub	Up	Box

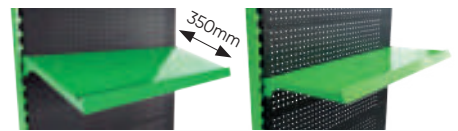

**14996** 65,00€

BANDEJA DE SUPORTE DE FERRAMENTAS COM PORTA

5,00	-	1	33
Kg	Sub	Up	Box

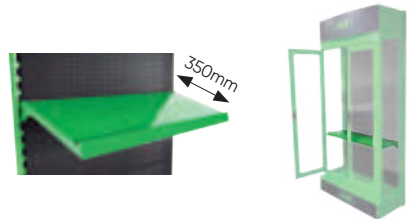

**14948** 251,50€

31,10	-	1	40
Kg	Sub	Up	Box

CONJUNTO DE 2 PORTAS PARA CREMALHEIRA DE FERRAMENTAS

**14945** 303,50€

37,80	-	1	14
Kg	Sub	Up	Box

ESTANTE DE FERRAMENTAS



# EXPOSITOR DE FERRAMENTAS + ILUMINAÇÃO

**53878** 574,00€

52,15	-	1	-
Kg	Sub	Up	Box



# EXPOSITOR DE FERRAMENTAS + ILUMINAÇÃO E PORTAS

**53879** 838,50€

83,25	-	1	-
Kg	Sub	Up	Box



## CONTÉM

**14945** x1



**14380** x1

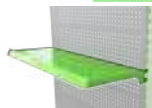

**14947** x1



**11318** x20



## CONTÉM

**14945** x1



**14948** x1



**14996** x1



**14947** x1





## BANDEJA

14622

17,00€

PARA REF. 60001, 60003, 60004, 60020

0,95	-	10	360
Kg	Sub	ff	ff

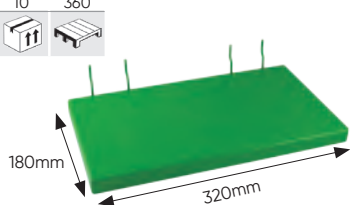

14624

17,00€

PARA REF. 60007, 60010, 60011

0,65	-	10	300
Kg	Sub	ff	ff

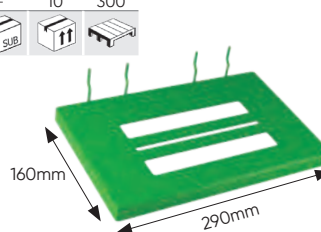

## GANCHO

14626

7,00€

PARA REF. 60023

0,10	-	10	-
Kg	Sub	ff	ff

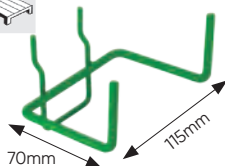

14623

8,00€

PARA REF. 60005, 60006, 60018

0,10	-	10	800
Kg	Sub	ff	ff

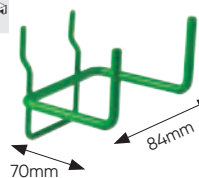

## GANCHO

PONTA COMPRIDA

11318

2,50€

0,04	20	600	-
Kg	Sub	ff	ff



PONTA DECHADA

51315

2,50€

0,02	20	320	44800
Kg	Sub	ff	ff



PARA FERRAMENTAS PNEUMÁTICAS

14034

9,00€

0,20	20	80	1920
Kg	Sub	ff	ff

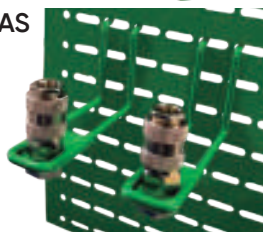

## GANCHO PARA REF. 60008, 60009

14625

14,00€

0,50	-	10	700
Kg	Sub	ff	ff

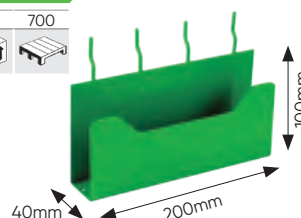

## EXPOSITOR PARA TAPETE

METEXP

62,00€

6,00	-	1	25
Kg	Sub	ff	ff



## EXPOSITOR DE FERRAMENTA PNEUMÁTICA

53492

380,00€

EXPOSITOR SEM FERRAMENTAS

13,00	-	1	7
Kg	Sub	ff	ff



## POSTE DE SEPARAÇÃO COM FITA RETRÁCTIL

53914 75,00€

8.50	-	5	90
Kg	sub	ff	



- Material: aço
- Diâmetro do tubo: 63 mm
- Diâmetro da base: 320 mm
- Altura: 910 mm

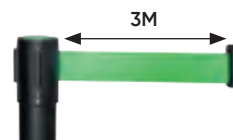

FITA DE 4 LADOS

- Fita de 4 lados
- Comprimento da correia: 3 m
- Largura da correia: 48 mm

## CAIXA DE FERRAMENTAS MANUAIS DE REPOSIÇÃO

REF.	cm	Kg	ff	€
14922	14,5x9x10	0,10	100	0,84€
14923	17,5x9x7	0,10	100	0,84€
14924	24x11x7	0,10	100	0,84€
14925	31,5x13x4	0,10	100	0,84€
14926	32x8,5x7	0,10	100	1,05€



## SELO DE GARANTIA JBM

14807 11,00€

0.45	6	24	864
Kg	sub	ff	



- 75mm de lar. x 125m de comp.
- Feito de polipropileno
- Adesivo solvente
- Espessura: 28 microns



TODOS OS IDIOMAS NO MESMO SELO

## CAIXA DE CARTÃO DE NATAL PROMOCIONAL

REF.	cm	Kg	ff	€
14976	80x31x61	2,20	1 80	18,84€
15056	40x30x61	1,60	1 70	11,70€
13717	76x14x29	0,90	1 200	7,65€
14083	80x28x49	1,80	1 100	13,20€



14083



13717



14976



15056



## CAIXA DE PAPELÃO JBM



12950



14189

14507

REF.	cm	Kg	ff	€
11330	19x10x11	0,05	50 4.200	0,57€
12952	40x30x20	0,40	30 360	1,92€
15051	40x32x30	0,40	20 160	1,92€
14974	54x24x40	0,65	20 150	2,28€
13217	57x30x25	0,55	15 150	1,31€
12950	60x40x30	0,80	15 75	3,45€

REF.	CARACTERISTICAS	Kg	ff	€
14189	Canal triplo de caixa palete americana 120x80x100cm	10	1 40	52,00€
14507	Caixa paleta europeia 120x98x80cm	8	1 40	50,00€



# LEGENDA



## LEGENDA CARACTERÍSTICAS GENERALES

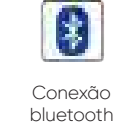
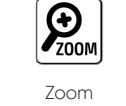

## LEGENDA DE MATERIAIS

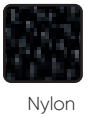

## LEGENDA DE FERRAMENTAS

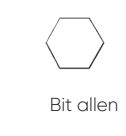
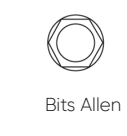
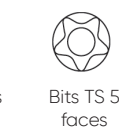
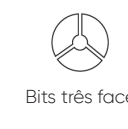
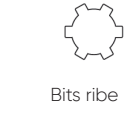
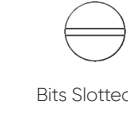

## LEGENDA DE PRODUCTOS NEUMÁTICOS

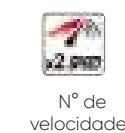
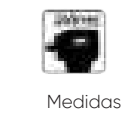
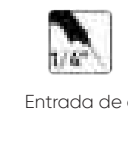
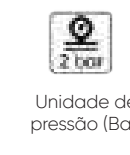

# LEGENDA



## LEGENDA DE PRODUTOS ELECTRÓNICOS

Tipo de Led: SMD	Tipo de Led: COB	Tipo de Led: Cree XP-E	Quantidade / potência Led	Quantidade de Leds	Distância de iluminação	3 intensidades de luz	Fluxo luminoso (Lumen)
Luz dispersa	Luz concentrada	Quantidade de tipos de flash	Potência Volts/Watts	Duração da bateria	Duração da carga	Tipo de bateria	Quantidade de pilhas: AAA
Transformador / tomada de parede	Carregador com USB	Toma de isqueiro	Base inclinada	Base inclinada	Gancho	Gancho giratório	Comprimento do cabo



## LEGENDA DE CERTIFICAÇÃO



Cumprimento da lei de segurança de produtos alemães.



Norma de luvas de proteção



## LEGENDA DE PRODUTOS UTILITÁRIOS



Compressor de molas



Desmontagem de amortecedores



## LEGENDA PRODUTOS LUBRIFICANTES



Capacidade do funil



Fluxo





# ÍNDICE NUMÉRICO

REF.	Pg.	PVP	REF.	Pg.	PVP	REF.	Pg.	PVP	REF.	Pg.	PVP
10054	192	2,90€	10569	38	4,50€	10674	205	9,50€	10831	329	0,20€
10055	192	3,90€	10570	38	4,50€	10675	205	9,50€	10832	329	0,20€
10485	193	8,10€	10571	38	5,00€	10720	280	24,50€	10833	329	0,20€
10486	193	8,00€	10579	38	3,00€	10721	280	19,00€	10834	329	0,25€
10494	193	6,50€	10580	38	3,10€	10722	280	24,50€	10835	329	0,25€
10495	193	3,00€	10581	38	3,40€	10723	280	29,50€	10836	329	0,30€
10496	193	3,00€	10582	38	4,00€	10724	280	29,50€	10837	329	0,30€
10497	193	3,00€	10583	38	4,15€	10731	79	17,60€	10838	329	0,30€
10498	193	3,00€	10584	38	5,05€	10732	79	18,70€	10839	329	0,40€
10499	193	3,00€	10585	38	6,75€	10733	79	17,50€	10840	329	0,35€
10500	193	3,00€	10586	38	7,60€	10735	79	20,30€	10868	333	0,30€
10501	193	8,10€	10587	38	9,80€	10750	124	13,00€	10869	333	0,30€
10502	193	3,50€	10588	38	10,50€	10751	124	15,00€	10870	333	0,45€
10527	36	13,10€	10589	38	2,00€	10761	280	16,00€	10871	333	0,30€
10528	36	15,80€	10590	38	2,40€	10762	280	23,50€	10872	333	0,40€
10529	36	18,00€	10591	40	2,50€	10766	124,130	1,59€	10873	333	0,45€
10530	36	28,70€	10592	40	2,55€	10767	252	21,00€	10874	333	0,30€
10531	37	3,00€	10593	40	3,15€	10768	261	113,00€	10875	333	0,40€
10532	37	2,70€	10594	40	3,20€	10769	261	21,00€	10876	333	0,45€
10533	37	3,00€	10595	40	3,35€	10770	261	6,00€	10877	327	0,25€
10534	37	3,25€	10596	40	4,25€	10772	328	0,05€	10878	327	0,30€
10535	37	3,50€	10597	40	4,50€	10773	328	0,10€	10879	327	0,20€
10536	37	3,65€	10598	40	4,60€	10774	328	0,10€	10880	327	0,20€
10537	37	3,90€	10599	40	6,00€	10775	328	0,15€	10881	327	0,25€
10538	37	4,30€	10600	40	6,25€	10776	328	0,20€	10882	325	0,25€
10539	37	4,75€	10601	40	6,50€	10777	328	0,20€	10883	325	0,25€
10540	37	5,25€	10602	40	7,05€	10778	328	0,35€	10884	325	0,25€
10541	37	5,55€	10603	40	2,10€	10779	326,328	0,05€	10885	335	0,20€
10542	37	5,85€	10604	40	2,25€	10780	326,328	0,05€	10886	335	0,20€
10543	37	7,00€	10617	36	14,10€	10781	326,328	0,05€	10887	335	0,25€
10544	37	8,10€	10618	36	15,10€	10782	328	0,05€	10888	335	0,30€
10545	37	9,75€	10619	36	15,70€	10783	328	0,05€	10889	335	0,30€
10546	37	11,60€	10620	36	16,20€	10784	326	0,05€	10890	335	0,35€
10547	37	13,50€	10621	36	9,50€	10785	326,328	0,10€	10891	335	0,25€
10548	37	1,75€	10622	36	10,00€	10786	326,328	0,15€	10892	335	0,30€
10549	37	2,00€	10623	36	12,60€	10787	328	0,05€	10893	335	0,25€
10550	37	2,15€	10624	36	13,50€	10788	328	0,05€	10894	335	0,20€
10551	37	2,15€	10625	36	15,70€	10789	328	0,05€	10895	335	0,20€
10552	34	7,10€	10626	36	17,80€	10790	328	0,05€	10896	335	0,30€
10553	34	7,35€	10627	39	2,80€	10791	328	0,05€	10897	335	0,30€
10554	34	7,50€	10628	39	3,10€	10792	328	0,05€	10898	335	0,30€
10555	34	7,80€	10629	39	3,65€	10793	325	0,25€	10899	335	0,30€
10556	34	8,10€	10630	39	3,90€	10794	325	0,40€	10900	335	0,30€
10557	34	8,10€	10631	39	4,20€	10795	325	0,60€	10901	335	0,25€
10558	34	9,35€	10632	39	5,30€	10805	326	0,10€	10902	335	0,30€
10559	34	9,50€	10633	39	6,60€	10812	326	0,30€	10905	335	0,25€
10560	34	10,60€	10634	39	7,80€	10813	326	0,30€	10906	335	0,25€
10561	34	11,00€	10635	39	8,15€	10823	329	0,20€	10907	335	0,25€
10562	34	12,30€	10636	39	8,80€	10824	329	0,20€	10908	335	0,30€
10563	34	12,50€	10637	39	12,10€	10825	329	0,20€	10909	335	0,30€
10564	38	2,50€	10638	39	12,70€	10826	329	0,40€	10910	335	0,30€
10565	38	3,50€	10639	261	10,90€	10827	329	0,60€	10911	335	0,30€
10566	38	3,50€	10671	270	15,20€	10828	329	0,45€	10912	335	0,25€
10567	38	3,50€	10672	205	9,50€	10829	329	0,20€	10913	335	0,30€
10568	38	4,00€	10673	205	9,50€	10830	329	0,20€	10914	335	0,25€

REF.	Pg.	PVP	REF.	Pg.	PVP	REF.	Pg.	PVP	REF.	Pg.	PVP
10915	334,335	0,25€	11152	155	57,00€	11318	353,352	2,50€	11891	313	0,50€
10916	335	0,30€	11153	154,155	23,40€	11323	267	16,00€	11892	270	12,50€
10917	334,335	0,30€	11154	155	21,70€	11324	124	17,50€	11893	190	7,00€
10918	334,335	0,30€	11155	154,155	24,40€	11325	124	17,50€	11894	190	7,00€
10919	334,335	0,30€	11156	155	28,90€	11328	298	4,00€	11895	190	8,65€
10920	334,335	0,25€	11157	155	26,60€	11329	276	564,00€	11896	190	8,80€
10921	334,335	0,30€	11158	154,155	28,50€	11330	354	0,57€	11897	172	155,00€
10923	119	1,10€	11159	155	30,30€	11360	28	2,60€	11900	310	3,50€
10925	252	18,00€	11160	155	27,00€	11362	28	5,20€	11901	310	2,50€
10945	298	2,30€	11161	155	32,30€	11363	28	3,90€	11902	310	3,50€
10953	195	12,50€	11162	155	29,10€	11364	28	4,50€	11903	310	5,00€
10955	178	11,00€	11163	155	32,70€	11365	28	9,40€	11904	310	2,00€
10961	120	13,00€	11164	155	30,70€	11374	178	5,50€	11905	310	1,50€
10962	264	85,00€	11165	155	34,60€	11375	178	6,50€	11906	310	8,50€
10964	172	9,00€	11166	155	30,90€	11376	178	5,50€	11907	310	11,00€
10965	172	6,00€	11167	155	38,00€	11377	178	5,50€	11938	152	47,00€
10966	172	13,50€	11168	155	41,00€	11378	178	6,50€	11939	261	63,00€
10993	269	117,00€	11169	155	39,20€	11379	178	6,00€	11945	54	7,00€
11093	120	4,00€	11170	155	40,00€	11380	178	6,50€	11946	54	4,50€
11095	280	31,00€	11171	155	51,00€	11381	178	6,50€	11947	54	19,00€
11098	280	57,00€	11172	155	48,00€	11382	178	6,00€	11950	269	18,00€
11100	279	24,30€	11173	155	47,00€	11383	178	6,00€	11956	137	5,50€
11101	279	154,00€	11174	155	47,00€	11384	178	6,00€	11957	137	5,50€
11102	279	6,60€	11175	155	49,00€	11385	178	5,50€	11959	168	10,50€
11103	124	6,00€	11176	155	56,00€	11386	178	6,00€	11960	309,310	1,50€
11106	180	3,00€	11177	155	55,00€	11387	178	6,00€	11962	150,154	7,50€
11107	120	4,50€	11178	155	53,00€	11388	178	6,00€	11963	154	9,00€
11121	150, 155	4,10€	11179	155	65,00€	11389	178	6,00€	11964	154	12,50€
	150, 155	5,45€	11180	155	59,00€	11390	178	6,00€	11965	154	16,00€
11123	150, 155	6,50€	11181	155	65,00€	11391	178	6,50€	11966	154	18,00€
11124	156	7,65€	11182	155	73,00€	11392	178	6,00€	11967	154	18,00€
11125	156	8,50€	11183	155	70,00€	11393	178	6,00€	11971	85	3,10€
11126	155	11,20€	11184	155	87,00€	11394	178	6,00€	11974	278	1,80€
11127	155	13,80€	11185	155	97,00€	11541	161	11,00€	11975	278	1,80€
11128	155	14,10€	11186	155	91,00€	11542	161	11,00€	11976	278	1,80€
11129	155	14,10€	11187	155	98,00€	11543	161	11,00€	11977	278	1,80€
11130	155	13,10€	11188	155	103,00€	11544	161	7,00€	11978	278	1,80€
11131	155	14,10€	11189	155	121,00€	11545	161	11,00€	11979	278	1,80€
11132	155	13,70€	11190	155	138,00€	11546	161	12,00€	11980	278	1,80€
11133	155	12,00€	11191	155	149,00€	11547	161	12,00€	11981	278	1,80€
11134	155	15,00€	11192	155	152,00€	11613	155	11,00€	11982	278	1,80€
11135	155	17,20€	11193	155	183,00€	11614	155	13,00€	11983	278	1,80€
11136	155	15,30€	11194	155	176,00€	11615	155	14,20€	11989	120	2,00€
11137	155	18,20€	11195	150, 155	3,70€	11616	155	18,10€	11990	150,152	15,30€
11138	155	18,00€	11212	46	5,00€	11617	155	18,70€	11992	276	65,00€
11139	155	18,80€	11213	46	10,60€	11618	155	18,80€	11994	79	33,00€
11140	155	20,40€	11214	46	12,50€	11619	155	19,50€	11996	79	48,00€
11141	155	18,60€	11219	276	659,00€	11621	155	359,00€	11997	79	39,00€
11142	155	21,30€	11244	40	8,50€	11622	155	399,00€	11998	79	49,00€
11143	155	26,40€	11245	40	9,15€	11623	155	489,00€	12009	139	11,00€
11144	155	33,30€	11246	40	12,40€	11624	155	189,00€	12022	167,270	33,70€
11145	155	35,30€	11247	40	14,00€	11625	155	282,00€	12029	30,196	5,50€
11146	155	37,30€	11248	40	14,60€	11628	151	9,50€	12030	30,196	6,50€
11147	155	41,00€	11249	40	26,50€	11867	256	9,00€	12031	150, 151, 155	15,00€
11148	155	47,00€	11313	81	54,00€	11878	211	4,10€	12032	267	7,50€
11149	155	45,00€	11314	151	13,00€	11879	211	5,10€	12044	255	147,00€
11150	155	55,00€	11315	151	8,50€	11880	211	10,50€	12046	264	385,00€
11151	155	57,00€	11316	151	8,50€	11890	313	0,55€	12055	294	20,00€



REF.	Pg.	PVP	REF.	Pg.	PVP	REF.	Pg.	PVP	REF.	Pg.	PVP
12056	252	57,00€	12974	175	21,00€	13049	338	2,05€	13108	336	1,90€
12060	47	2,50€	12975	175	23,00€	13050	339	1,55€	13109	336	2,90€
12061	155	9,50€	12977	208	36,50€	13051	339	1,50€	13110	336	1,85€
12062	150, 151, 155	9,50€	12984	155	379,00€	13053	339	2,80€	13111	336	1,20€
12063	150, 151, 155	9,50€	12987	142	1,50€	13054	339	2,35€	13112	336	1,65€
12064	155,150	9,00€	12988	148	12,00€	13055	339	3,00€	13113	336	2,20€
12065	150, 151, 155	9,00€	12995	54	7,00€	13056	339	1,55€	13114	336	2,20€
12066	150, 151, 155	9,00€	12996	54	7,00€	13057	339	1,50€	13115	336	2,50€
12067	155,150	9,50€	12997	54	7,50€	13058	339	2,20€	13116	340	5,45€
12068	150, 151, 155	9,50€	12998	54	9,00€	13059	339	2,35€	13117	340	3,65€
12069	150, 151, 155	9,50€	12999	54	9,50€	13060	339	1,60€	13118	340	15,90€
12070	150, 151, 155	10,50€	13002	336	1,45€	13061	339	2,65€	13119	340	5,60€
12071	150, 151, 155	11,00€	13003	336	1,70€	13062	339	2,35€	13120	340	5,50€
12072	150, 151, 155	12,00€	13004	336	1,85€	13063	339	1,15€	13121	340	8,75€
12074	150,152	11,50€	13005	336	1,25€	13064	339	2,60€	13122	340	1,95€
12075	150,152	15,50€	13006	336	1,40€	13065	339	2,00€	13123	340	5,35€
12200	208	14,50€	13007	336	1,30€	13066	339	2,25€	13124	340	8,20€
12889	270	12,00€	13008	336	2,25€	13067	339	2,55€	13125	340	5,95€
12901	185	5,20€	13009	336	1,65€	13068	338	2,85€	13126	340	1,55€
12902	309	4,50€	13010	336	1,75€	13069	338	4,55€	13127	340	5,60€
12908	309	4,50€	13011	336	1,15€	13070	338	2,15€	13128	337	1,85€
12910	309	4,40€	13012	336	1,80€	13071	338	2,05€	13129	337	2,00€
12915	309	12,40€	13013	336	1,75€	13072	338	2,75€	13130	337	3,75€
12920	309	7,80€	13014	336	1,45€	13073	338	2,10€	13131	337	3,45€
12923	309	9,50€	13015	336	1,20€	13074	339	4,65€	13132	337	2,65€
12924	309	4,10€	13016	336	1,15€	13075	339	5,35€	13133	337	3,45€
12925	309	10,70€	13017	336	2,60€	13076	339	3,90€	13134	337	3,95€
12926	200	21,50€	13018	336	1,45€	13077	339	2,55€	13135	337	3,45€
12927	200	21,50€	13019	336	1,75€	13078	339	2,55€	13136	337	2,60€
12928	200	22,00€	13020	336	1,70€	13079	339	3,35€	13137	337	2,25€
12929	200	23,00€	13021	336	1,30€	13080	338	1,75€	13138	337	2,85€
12930	200	23,50€	13022	336	2,10€	13081	338	2,30€	13139	337	3,85€
12931	153	7,50€	13023	336	1,50€	13082	338	1,35€	13140	337	2,65€
12932	153	7,50€	13024	336	2,45€	13083	338	1,50€	13141	337	1,80€
12933	153	8,00€	13025	336	1,50€	13084	338	2,10€	13142	337	3,10€
12934	153	7,50€	13026	341	1,55€	13085	338	1,60€	13143	337	1,95€
12935	153	8,00€	13027	341	1,85€	13086	338	1,25€	13144	337	2,20€
12936	153	8,50€	13028	341	1,45€	13087	338	3,30€	13145	337	3,85€
12937	150,152	9,50€	13029	341	1,65€	13088	338	2,40€	13146	337	4,50€
12938	153	10,00€	13030	341	2,80€	13089	338	1,70€	13147	337	3,10€
12939	153	10,00€	13031	341	1,85€	13090	338	1,70€	13148	337	3,30€
12940	153	10,00€	13032	341	2,00€	13091	338	1,25€	13149	337	3,10€
12941	153	10,00€	13033	341	1,60€	13092	340	1,65€	13150	337	2,25€
12942	153	10,00€	13034	341	2,65€	13093	340	2,95€	13151	337	5,35€
12943	153	10,00€	13035	341	1,65€	13094	340	1,50€	13152	337	3,05€
12944	153	10,00€	13036	341	1,40€	13095	340	1,20€	13153	337	3,10€
12945	153	10,50€	13037	341	2,10€	13096	340	1,70€	13154	337	3,20€
12950	354	3,45€	13038	338	1,40€	13097	340	1,20€	13155	337	5,60€
12952	354	1,92€	13039	338	1,65€	13098	340	1,65€	13156	337	3,30€
12954	335	0,25€	13040	338	1,80€	13099	340	2,75€	13157	337	3,85€
12955	160	27,80€	13041	338	1,55€	13100	340	1,20€	13158	337	3,75€
12956	160	45,00€	13042	338	1,95€	13101	340	1,50€	13159	337	3,20€
12957	160	27,80€	13043	338	1,20€	13102	340	1,60€	13160	337	5,00€
12958	160	27,80€	13044	338	1,55€	13103	340	1,80€	13161	337	3,55€
12959	160	27,80€	13045	338	1,20€	13104	336	1,90€	13162	337	2,60€
12960	160	27,80€	13046	338	1,55€	13105	336	2,50€	13163	337	2,80€
12961	160	27,80€	13047	338	1,45€	13106	336	2,00€	13217	354	1,31€
12973	310	1,00€	13048	338	2,20€	13107	336	2,15€	13226	49	4,50€

REF.	Pg.	PVP	REF.	Pg.	PVP	REF.	Pg.	PVP	REF.	Pg.	PVP
13227	49	4,50€	13497	35	7,50€	13817	138	17,00€	13961	330	9,25€
13228	49	4,50€	13498	35	8,50€	13818	138	20,50€	13962	330	1,76€
13229	49	4,50€	13499	139	12,50€	13822	329	11,00€	13963	330	12,40€
13230	49	4,50€	13500	139	12,90€	13823	329	6,00€	13964	330	15,00€
13231	49	4,50€	13667	49,79	17,60€	13824	329	8,00€	13965	330	1,50€
13232	49	4,50€	13668	79	18,70€	13825	329	11,50€	13966	330	12,90€
13234	255	224,50€	13669	57	18,00€	13826	329	13,00€	13967	330	4,65€
13235	327	0,15€	13672	267	220,00€	13827	329	15,00€	13968	349	1,35€
13236	327	0,15€	13674	50,327	0,50€	13828	329	11,50€	13969	181	19,00€
13237	327	0,15€	13675	50,327	0,50€	13829	329	10,50€	13982	252	4,00€
13238	327	0,20€	13676	50,327	0,50€	13830	329	10,50€	14004	153	9,50€
13239	327	0,20€	13677	50,327	0,50€	13831	329	12,60€	14005	153	10,50€
13240	327	0,40€	13678	50,327	0,50€	13832	329	13,00€	14006	153	9,50€
13241	327	0,55€	13680	152	15,50€	13833	329	9,00€	14007	153	9,50€
13243	349	12,50€	13681	152	15,50€	13836	260	9,00€	14008	153	9,50€
13244	349	12,50€	13682	152	15,50€	13839	120	8,50€	14009	153	9,50€
13245	349	12,50€	13683	152	15,50€	13842	160	8,50€	14010	153	11,00€
13447	36	16,50€	13684	152	15,50€	13843	160	7,00€	14011	153	11,00€
13448	36	17,50€	13685	152	15,50€	13844	160	9,00€	14013	138	3,50€
13449	36	20,00€	13686	152	15,50€	13845	160	8,00€	14014	253	6,00€
13450	36	23,00€	13687	152	15,50€	13853	260	122,00€	14015	253	6,00€
13451	36	28,00€	13688	152	15,50€	13856	180	7,80€	14016	253	6,00€
13452	36	29,50€	13689	152	15,50€	13859	154	16,00€	14026	54	5,50€
13453	34	9,00€	13704	204	21,00€	13870	265	82,00€	14027	54	5,60€
13454	34	9,50€	13707	61	14,00€	13874	154	17,50€	14028	54	7,00€
13455	34	10,50€	13708	61	14,00€	13875	154	18,50€	14029	54	8,50€
13456	34	11,50€	13709	61	14,00€	13876	154	18,50€	14030	54	9,50€
13457	34	12,00€	13710	61	14,00€	13877	154	18,50€	14031	115,120	7,90€
13460	34	15,00€	13712	61	14,00€	13879	314	1,38€	14032	120	12,00€
13462	34	17,00€	13717	354	7,65€	13880	314	1,50€	14033	120	4,50€
13463	35	5,30€	13723	155	18,50€	13923	79	7,45€	14034	353	9,00€
13464	35	5,30€	13724	155	19,20€	13929	346	3,45€	14049	63	8,00€
13465	35	5,55€	13725	155	19,20€	13930	148	1,50€	14050	63	10,50€
13466	35	5,55€	13726	155	19,00€	13931	148	2,50€	14051	63	18,00€
13467	35	6,00€	13727	155	18,70€	13932	148	2,50€	14052	63	19,50€
13468	35	6,25€	13728	155	18,50€	13933	148	2,00€	14059	73	62,00€
13469	35	6,25€	13729	155	22,00€	13934	148	2,50€	14060	73	65,00€
13470	35	6,60€	13730	155	22,00€	13935	148	2,50€	14061	73	93,00€
13471	35	6,90€	13731	155	21,60€	13936	148	3,50€	14062	73	100,00€
13472	35	7,25€	13732	155	21,60€	13937	148	4,00€	14063	73	119,00€
13473	35	8,10€	13733	155	24,90€	13938	148	3,50€	14064	73	39,50€
13474	35	8,70€	13734	155	25,70€	13939	148	4,00€	14068	260	13,00€
13475	35	9,10€	13735	155	25,80€	13945	330	7,40€	14069	260	13,00€
13476	35	9,60€	13736	155	25,90€	13946	330	6,70€	14070	260	116,00€
13477	35	9,85€	13738	314	3,50€	13947	330	5,85€	14071	260	21,50€
13478	35	12,20€	13739	314	5,50€	13948	330	5,00€	14072	260	21,50€
13479	35	13,10€	13740	314	5,50€	13949	330	6,50€	14073	260	128,00€
13480	35	15,50€	13741	313	21,00€	13950	330	7,80€	14075	148	2,00€
13481	35	15,80€	13745	155	25,20€	13951	330	5,15€	14076	148	1,50€
13482	35	22,10€	13746	155	25,40€	13952	330	10,90€	14077	148	4,50€
13483	35	25,50€	13747	155	25,40€	13953	330	8,00€	14078	148	4,00€
13484	35	27,20€	13748	155	24,90€	13954	330	12,70€	14081	276	12,60€
13491	35	5,30€	13805	310	10,50€	13955	330	4,95€	14083	354	13,20€
13492	35	5,35€	13806	310	10,50€	13956	330	4,30€	14090	267	103,00€
13493	35	5,50€	13809	148	18,50€	13957	330	9,70€	14103	164	32,40€
13494	35	6,00€	13810	148	20,50€	13958	330	5,45€	14104	164	32,40€
13495	35	6,40€	13813	163	7,00€	13959	330	10,10€	14105	164	32,40€
13496	35	6,60€	13814	163	11,00€	13960	330	9,65€	14106	164	32,40€



REF.	Pg.	PVP	REF.	Pg.	PVP	REF.	Pg.	PVP	REF.	Pg.	PVP
14107	164	32,40€	14192	148	4,00€	14365	344	1,90€	14432	342	1,45€
14108	164	32,40€	14193	148	4,00€	14366	344	1,45€	14434	342	1,60€
14109	276	29,00€	14195	147	4,00€	14367	344	1,30€	14435	342	1,45€
14110	276	110,00€	14196	147	4,00€	14368	344	1,45€	14436	342	1,70€
14114	79	19,30€	14197	147	4,50€	14369	344	4,95€	14437	342	1,45€
14118	302	26,00€	14198	147	4,00€	14370	344	3,00€	14438	342	1,35€
14120	132	22,00€	14199	147	4,00€	14371	344	3,00€	14439	342	1,75€
14121	132	26,00€	14200	147	4,50€	14372	344	1,20€	14440	342	1,75€
14122	133	34,00€	14201	147	4,00€	14373	344	1,35€	14441	342	1,65€
14123	133	33,00€	14202	147	4,00€	14374	344	1,70€	14442	342	1,45€
14124	135	20,50€	14203	147	4,50€	14375	344	1,85€	14443	342	1,45€
14125	135	19,50€	14204	147	1,50€	14376	344	2,60€	14444	342	1,90€
14126	136	54,00€	14205	147	1,50€	14377	344	1,90€	14445	342	1,45€
14127	135	32,50€	14206	147	1,50€	14378	344	1,90€	14446	342	2,80€
14128	136	13,50€	14207	147	1,50€	14379	344	1,45€	14447	341,342	1,45€
14129	135	12,50€	14208	147	1,50€	14380	352	51,00€	14448	342	2,05€
14130	134	21,00€	14209	147	1,50€	14381	344	1,70€	14449	341,342	2,20€
14131	134	24,00€	14211	192	11,00€	14382	344	1,85€	14450	342	2,15€
14132	135	21,50€	14212	192	12,00€	14383	344	1,35€	14451	342	2,15€
14133	136	16,50€	14213	192	12,00€	14384	344	2,10€	14452	342	2,55€
14134	136	17,50€	14214	192	14,00€	14387	343	1,45€	14453	342	3,05€
14135	137	12,50€	14286	139,161	2,99€	14388	343	2,05€	14455	342	2,10€
14136	138	12,00€	14287	139,161	2,99€	14389	343	1,25€	14456	342	1,35€
14137	138	131,00€	14288	139,161	6,00€	14390	343	1,35€	14457	342	1,70€
14141	73	105,00€	14289	139,161	6,10€	14391	343	2,15€	14458	341	1,70€
14142	73,175	109,00€	14291	269	87,00€	14392	343	1,35€	14459	341	1,45€
14143	73	124,00€	14296	66,67,68, 69,73,74,76	118,00€	14393	343	1,50€	14460	341	1,15€
14144	73	304,00€	14297	66,67,68, 69,74,76	87,00€	14395	343	1,65€	14461	341	1,35€
14145	272	8,50€	14298	66,67,68, 69,74,76	51,50€	14396	343	1,20€	14462	341	1,65€
14146	272	8,00€	14299	66,67,68, 69,74,76	87,00€	14397	343	1,45€	14463	341	1,65€
14147	272	25,00€	14300	207	19,00€	14398	343	1,30€	14464	341	1,50€
14148	272	25,00€	14301	207	19,00€	14399	343	1,90€	14465	341	2,00€
14153	134	20,50€	14314	147	5,00€	14402	343	1,50€	14466	341	1,65€
14154	139	42,00€	14315	147	4,50€	14404	343	2,10€	14468	341	1,30€
14157	138,210	8,30€	14330	139	3,50€	14405	343	1,45€	14469	341	1,45€
14158	138,210	9,95€	14336	134	58,00€	14406	343	1,55€	14471	341	1,90€
14159	138,210	12,60€	14340	191	10,50€	14408	343	1,45€	14472	341	1,35€
14160	138,210	12,80€	14341	191	10,50€	14409	343	1,35€	14473	251	46,00€
14161	138,210	13,70€	14342	191	10,50€	14410	343	1,85€	14474	341	1,50€
14162	139	25,50€	14343	191	10,50€	14411	343	1,70€	14475	341	1,65€
14163	139	25,50€	14344	191	11,00€	14412	343	1,70€	14476	341	2,05€
14164	139	25,50€	14345	191	11,00€	14413	343	3,25€	14477	341	2,45€
14165	132	26,50€	14346	191	11,00€	14414	343	1,70€	14478	341	4,05€
14167	62	2,50€	14347	348	36,50€	14415	343	1,70€	14479	341	1,65€
14168	145	7,00€	14348	186	12,50€	14416	343,344	1,25€	14480	341	2,05€
14169	147	3,00€	14349	186	20,50€	14419	343	1,95€	14481	341	1,70€
14172	151	8,50€	14350	343,344	1,80€	14420	343	1,50€	14507	354	50,00€
14173	151	9,50€	14351	344	1,65€	14421	343	2,45€	14534	144	16,50€
14177	151	9,50€	14352	344	1,30€	14422	342	1,50€	14560	144	8,80€
14178	151	9,50€	14353	344	2,10€	14423	342	3,55€	14561	144	8,80€
14179	60	8,50€	14354	80	14,00€	14424	342	1,85€	14563	209	18,00€
14180	60	7,90€	14355	344	1,70€	14425	342	2,05€	14564	161	9,20€
14183	44	31,00€	14356	344	1,90€	14426	342	1,90€	14565	161	26,70€
14187	208	6,00€	14357	344	1,90€	14427	342	1,20€	14566	161	16,70€
14188	141	0,50€	14358	343,344	1,70€	14428	342	1,40€	14567	161	38,00€
14189	354	52,00€	14359	341,344	1,05€	14429	342	1,80€	14568	161	9,20€
14190	148	2,00€	14364	344	1,90€	14430	342	2,25€	14569	161	9,20€
14191	148	2,00€				14431	342	1,45€	14570	161	4,05€

REF.	Pg.	PVP	REF.	Pg.	PVP	REF.	Pg.	PVP	REF.	Pg.	PVP
14571	161	9,20€	14660	94	83,00€	14733	150,155	4,30€	14838	93,109	3,40€
14573	161	4,05€	14661	94	9,00€	14734	150,155	5,40€	14839	93,109	4,70€
14578	80	12,50€	14662	94	2,50€	14735	150	6,50€	14840	93,109	3,35€
14580	80	41,00€	14663	94	2,50€	14736	151,155	5,00€	14841	93,109	2,58€
14583	132	6,00€	14664	95	100,00€	14737	151,155	5,00€	14842	93,109	9,50€
14589	267	2,50€	14665	95	8,80€	14738	155	5,50€	14843	110	0,50€
14594	207,331	2,00€	14666	95	97,00€	14739	155	5,50€	14844	110	0,50€
14595	207,331	1,50€	14667	95	8,80€	14740	155	5,55€	14845	110	0,50€
14596	207,331	2,00€	14668	95	7,70€	14741	155	5,55€	14846	110	0,50€
14597	207,331	7,60€	14670	95	4,50€	14742	155	5,55€	14847	110	0,50€
14598	207,331	17,80€	14671	96	44,00€	14743	155	5,15€	14848	110	0,50€
14599	207,331	4,50€	14672	96	5,00€	14744	155	5,35€	14849	110	1,00€
14600	207,331	9,50€	14674	96	73,00€	14745	155	6,25€	14850	110	1,00€
14601	207,331	11,00€	14675	88,90	17,00€	14746	155	6,40€	14851	110	1,00€
14602	207,331	11,00€	14676	88,90	36,50€	14747	155	7,10€	14852	110	1,00€
14611	197	12,00€	14677	88,90	9,00€	14748	155	8,30€	14853	110	1,00€
14612	197	11,00€	14678	88,90	86,00€	14749	28,154	2,00€	14854	110	1,00€
14613	197	13,50€	14679	88,90	9,50€	14750	28,154	2,00€	14855	110	1,00€
14615	261	9,50€	14680	95	17,00€	14751	28,154	4,00€	14856	110	1,00€
14616	266	96,00€	14681	95	108,00€	14752	28,154	4,00€	14857	110	1,50€
14618	133	19,00€	14682	95	9,00€	14753	129	13,00€	14858	110	1,50€
14622	107,353	17,00€	14683	95	86,00€	14755	272	134,00€	14859	110	1,50€
14623	107,353	8,00€	14684	94	3,00€	14756	272	15,20€	14860	110	2,00€
14624	107,353	17,00€	14685	94	5,00€	14757	272	15,20€	14861	110	2,00€
14625	107,353	14,00€	14686	94	73,00€	14758	272	18,00€	14862	110	2,00€
14626	107,353	7,00€	14687	94	35,00€	14759	272	18,00€	14863	110	2,50€
14628	101	2,50€	14691	97	167,00€	14765	91	97,00€	14864	110	2,50€
14629	101	4,00€	14692	97	5,50€	14766	92	3,15€	14865	110	2,50€
14630	101	22,00€	14693	93	3,50€	14767	92	2,34€	14866	110	3,00€
14631	101	3,50€	14694	93	11,50€	14768	95	28,80€	14867	110	3,00€
14632	101	3,50€	14695	93	4,00€	14769	88,90	37,75€	14868	110	0,55€
14633	132	22,50€	14696	93	18,00€	14770	95	40,00€	14869	110	0,60€
14634	101	36,50€	14697	93	8,00€	14771	146,283	10,50€	14870	110	1,00€
14635	101	10,00€	14698	93	1,00€	14772	146	8,50€	14871	110	1,00€
14636	102	30,00€	14699	93	30,00€	14774	283	10,50€	14872	110	1,00€
14637	91	15,50€	14700	93	2,50€	14775	322	30,50€	14873	110	1,00€
14638	91	7,00€	14701	93	2,50€	14779	135	33,00€	14874	110	1,00€
14639	266	195,00€	14702	93	92,00€	14781	319	9,90€	14875	110	1,50€
14640	91	8,00€	14703	251	13,00€	14783	80	5,50€	14876	110	1,50€
14641	91	18,50€	14706	269	8,90€	14785	270	3,50€	14877	110	1,50€
14642	91	83,00€	14708	261	59,00€	14793	319	12,00€	14878	110	2,00€
14643	92	24,50€	14709	260	122,00€	14802	322	44,00€	14879	110	2,00€
14644	92	8,00€	14710	161	3,50€	14803	322	43,00€	14880	110	2,50€
14645	92	45,00€	14711	161	3,75€	14807	354	11,00€	14881	110	2,50€
14646	92	110,00€	14712	161	4,00€	14808	92	3,05€	14882	110	3,00€
14647	96	3,00€	14713	161	4,25€	14825	109	1,50€	14883	110	3,50€
14648	88,90	106,00€	14714	161	4,50€	14826	109	1,50€	14884	110	3,65€
14649	96	50,00€	14715	161	4,75€	14827	109	2,00€	14885	110	4,00€
14650	96	5,00€	14723	154	18,00€	14828	109	1,50€	14886	110	4,60€
14651	96	86,00€	14724	154	18,50€	14829	109	1,50€	14887	110	5,00€
14652	92	47,00€	14725	154	18,50€	14830	109	1,50€	14888	110	6,00€
14653	92	5,25€	14726	154	17,50€	14831	109	1,50€	14889	110	6,50€
14654	92	104,00€	14727	269	108,00€	14832	109	2,00€	14890	110	7,00€
14655	92	5,95€	14728	150,155	3,80€	14833	109	2,05€	14891	110	7,50€
14656	92	4,50€	14729	150,155	3,80€	14834	109	2,50€	14892	110	8,00€
14657	92	4,50€	14730	150,155	3,80€	14835	109	3,00€	14893	92,112	2,00€
14658	94	45,00€	14731	150,155	3,80€	14836	109	3,50€	14894	112	1,20€
14659	94	5,00€	14732	150,155	3,80€	14837	93,109	3,30€	14895	112	1,90€



REF.	Pg.	PVP	REF.	Pg.	PVP	REF.	Pg.	PVP	REF.	Pg.	PVP
14896	112	2,10€	14962	96	6,50€	15051	354	1,92€	15144	82	30,00€
14897	112	0,88€	14963	96	7,50€	15052	208	3,00€	15145	82	20,45€
14898	112	0,98€	14964	94	8,00€	15053	208	10,50€	15146	82	16,20€
14899	112	0,88€	14965	94	8,50€	15054	208	34,00€	15147	53	5,00€
14900	92,112	0,98€	14966	97	7,50€	15056	354	11,70€	15148	53	5,00€
14901	111	3,60€	14967	93	5,50€	15058	80	7,50€	15149	53	5,00€
14902	111	4,65€	14968	93	6,00€	15059	319	10,00€	15151	101	10,50€
14903	111	5,25€	14970	150	2,50€	15062	319	1,00€	15152	348	160,00€
14904	111	6,85€	14971	150	2,50€	15065	80	6,50€	15153	292	2,50€
14905	111	8,50€	14972	150	3,50€	15068	80	15,20€	15154	292	7,50€
14906	111	10,20€	14973	150	11,50€	15069	80	32,80€	15155	67,77	59,00€
14907	109	0,50€	14974	354	2,28€	15070	75	0,50€	15156	39,77	70,00€
14908	109	0,60€	14975	351	64,00€	15071	74	0,60€	15157	77	42,00€
14909	109	0,80€	14976	354	18,84€	15072	74	0,70€	15158	77	59,00€
14910	109	1,00€	14978	54	7,50€	15073	74	1,00€	15159	77	44,00€
14911	109	1,30€	14979	54	9,00€	15074	74	1,00€	15160	77	42,00€
14912	109	1,55€	14980	54	13,00€	15075	74	1,20€	15161	67,77	62,00€
14913	109	1,90€	14981	54	22,50€	15076	74	3,50€	15162	32,78,289	30,20€
14914	109	2,10€	14982	54	27,50€	15083	75	8,50€	15206	39	15,00€
14915	109	2,65€	14985	96,112	6,00€	15084	75,181	68,00€	15207	39	16,50€
14916	109	2,95€	14986	96,112	4,00€	15085	270	156,00€	15208	39	17,00€
14917	109	3,45€	14987	97,112	8,50€	15093	262	38,00€	15209	39	18,00€
14918	301,320	0,23€	14988	96,112	8,00€	15094	262	39,50€	15227	32	3,50€
14919	301,320	0,45€	14989	96,112	6,00€	15095	262	13,00€	15228	32	4,00€
14920	109	2,50€	14990	97,112	10,50€	15096	262	40,00€	15229	32	5,00€
14922	354	0,84€	14991	95,112	2,00€	15098	104	11,50€	15230	32	5,00€
14923	354	0,84€	14992	178	8,50€	15099	104	5,50€	15231	32	3,50€
14924	354	0,84€	14993	95,112	5,00€	15100	104	70,00€	15232	32	4,00€
14925	354	0,84€	14994	95,112	3,50€	15101	104	11,00€	15233	32	5,00€
14926	354	1,05€	14995	95,112	8,00€	15102	104	40,00€	15234	32	3,00€
14929	264	35,00€	14996	352	65,00€	15103	104	20,50€	15237	277	12,00€
14930	182	9,50€	15001	344	3,00€	15104	104	31,50€	15238	277	5,00€
14931	182	8,00€	15010	214	16,50€	15105	104	30,00€	15239	277	5,50€
14932	182	9,50€	15011	214	18,00€	15106	104	15,00€	15240	277	9,50€
14933	182	9,50€	15012	214	31,50€	15107	105	4,00€	15241	277	65,00€
14934	111	4,25€	15014	92,112	20,00€	15108	105	2,16€	15242	277	2,50€
14935	111	8,45€	15018	75,253	46,00€	15109	105	25,50€	15243	277	4,00€
14936	94	27,50€	15023	80	12,50€	15110	105	6,55€	15244	277	2,00€
14937	253	9,50€	15024	80	15,00€	15111	105	30,40€	15245	277	7,50€
14938	270	42,00€	15025	80	12,50€	15112	105	3,25€	15246	277	108,00€
14939	270	57,00€	15026	80	15,00€	15113	105	11,80€	15247	277	2,50€
14940	270	248,00€	15030	80	8,00€	15114	104	6,00€	15248	277	2,50€
14945	352	303,50€	15033	80	6,00€	15115	104	8,50€	15249	277	5,00€
14946	352	58,00€	15034	80	57,00€	15116	104	29,50€	15250	277	4,50€
14947	352	201,50€	15035	80	8,50€	15117	104	29,50€	15251	277	15,00€
14948	352	251,50€	15036	80	8,50€	15118	104	52,00€	15253	196,202	62,00€
14950	101	6,50€	15037	80	8,00€	15119	104	10,00€	15254	91	12,50€
14951	101	9,50€	15038	80	34,50€	15120	104	6,50€	15255	265	114,00€
14952	101	19,00€	15040	80	12,50€	15121	104	12,00€	15256	348	36,00€
14953	101	8,50€	15041	80	15,00€	15122	35,67,77	74,00€	15257	348	27,50€
14954	92	14,50€	15042	80	7,50€	15123	251	32,00€	15258	348	27,50€
14955	96	7,50€	15043	266	195,00€	15124	102	9,50€	15259	348	18,00€
14956	92	4,40€	15044	266	259,00€	15125	102	23,00€	15260	348	22,50€
14957	92	4,10€	15046	266	47,00€	15126	99	19,50€	15276	98	46,00€
14958	94	22,00€	15047	266	47,00€	15127	99	29,00€	15277	98	9,00€
14959	94	10,00€	15048	266	5,00€	15138	51	10,50€	15278	98	3,50€
14960	95	3,85€	15049	102	37,40€	15139	51	12,00€	15279	98	69,00€
14961	95	3,95€	15050	80	9,50€	15140	51	13,50€	15280	98	91,00€

REF.	Pg.	PVP	REF.	Pg.	PVP	REF.	Pg.	PVP	REF.	Pg.	PVP
15282	253	15,00€	15398	282	75,00€	15500	178	10,00€	15732	70,76	293,50€
15283	253	27,50€	15399	282	117,00€	15501	178	10,00€	15733	70,76	113,00€
15300	309	5,00€	15424	106,281	105,00€	15502	178	10,00€	15734	70,76	288,50€
15305	253	19,50€	15425	106,281	50,00€	15503	178	11,00€	15735	76	38,00€
15306	253	27,50€	15426	106,281	10,00€	15504	178	10,00€	15736	76	488,50€
15307	253	39,60€	15427	106,281	9,00€	15505	178	4,00€	15737	48,78	45,00€
15308	253	7,00€	15428	106,281	238,00€	15506	178	4,00€	15765	101	14,00€
15309	253	17,00€	15429	106,281	23,50€	15507	178	4,50€	15781	272	19,84€
15310	253	11,50€	15430	106,281	83,00€	15508	178	4,50€	15782	272	16,00€
15311	253	11,50€	15431	106,281	241,00€	15509	178	5,00€	15789	350	2.545,00€
15312	253	11,50€	15432	106,281	18,50€	15510	178	5,00€	15799	46,79	28,30€
15313	80	14,00€	15433	106,281	197,00€	15511	178	8,00€	15866	293	32,00€
15315	78	28,20€	15434	106,281	147,00€	15514	67,78	9,35€	15874	249	6,50€
15316	36,77	58,00€	15435	106,281	24,50€	15515	36	15,50€	15905	296	16,50€
15317	309	4,50€	15436	106,281	97,00€	15516	36	19,00€	15906	296	28,50€
15318	253	17,00€	15437	106,281	305,50€	15517	36	22,50€	15907	296	12,00€
15320	98	1,00€	15438	106,281	31,00€	15526	264	48,00€	15908	296	14,50€
15321	98	3,00€	15439	106,281	52,00€	15527	264	276,00€	15909	296	21,50€
15322	98	3,50€	15440	99	33,00€	15528	264	39,00€	15910	296	16,50€
15323	98	24,00€	15454	58,77	35,40€	15530	93	7,50€	15911	296	30,50€
15324	98	18,00€	15460	287	5,00€	15531	93	5,00€	15912	296	35,50€
15325	98	3,50€	15462	105	7,50€	15532	93	98,00€	15913	296	7,50€
15326	98	1,00€	15463	105	114,00€	15533	93	4,50€	15914	296	7,50€
15327	98	5,50€	15464	105	6,50€	15534	93	4,50€	15980	250	55,00€
15328	35	6,00€	15465	105	11,50€	15535	93	3,50€	15981	250	181,00€
15329	35	5,50€	15466	105	6,50€	15536	93	14,50€	15982	250	73,00€
15330	35	5,50€	15467	105	14,00€	15537	93	6,00€	15983	250	11,50€
15331	35	5,50€	15468	105	2,50€	15538	93	17,00€	15984	250	48,00€
15332	35	6,00€	15469	105	9,50€	15539	255	104,00€	16020	37	17,00€
15333	35	6,50€	15470	105	7,50€	15541	77	27,60€	16021	37	19,50€
15334	35	7,00€	15471	105	20,10€	15542	255	45,00€	16022	37	23,00€
15335	35	7,50€	15472	105	19,00€	15550	253	6,00€	16023	37	26,50€
15336	35	8,00€	15473	105	13,70€	15551	253	6,00€	16024	37	34,50€
15337	35	8,50€	15474	105	8,50€	15552	172	181,00€	16025	37	37,50€
15338	35	9,00€	15475	105	8,50€	15553	250	108,00€	16052	120,123	2,09€
15339	35	9,50€	15476	105	11,00€	15564	133	11,90€	16053	120,123	2,85€
15340	349	5,50€	15477	105	5,70€	15631	251	98,00€	16111	79	19,20€
15341	349	5,50€	15478	105	3,60€	15632	34	9,35€	16130	287	290,00€
15342	349	9,00€	15480	255	0,99€	15633	34	9,50€	16138	106	7,45€
15343	349	9,50€	15481	103	4,50€	15634	34	10,60	16139	106	14,20€
15344	349	6,50€	15482	103	4,00€	15635	34	11,00€	16140	106	14,20€
15345	349	10,50€	15483	103	4,00€	15636	34	12,30€	16141	106	4,45€
15346	349	24,00€	15484	103	5,50€	15637	34	12,50€	16142	106	10,80€
15349	349	8,50€	15485	103	4,00€	15681	55,78	134,00€	16143	106	2,06€
15375	161	28,00€	15486	103	9,00€	15671	297	20,50€	16144	106	12,80€
15380	99	169,00€	15487	103	59,00€	15706	55,78	31,00€	16145	106	79,00€
15381	99	5,50€	15488	103	4,00€	15708	58	10,00€	16146	106	4,45€
15382	99	42,00€	15489	103	10,50€	15710	58	10,00€	16147	106	13,00€
15385	122	18,00€	15490	103	4,00€	15719	100	11,00€	16148	106	35,40€
15388	282	33,00€	15491	103	4,00€	15720	100	59,00€	16149	106	38,60€
15389	282	18,50€	15492	103	5,00€	15721	100	46,00€	16150	100	7,90€
15390	282	43,00€	15493	103	4,50€	15722	100	4,25€	16151	89	50,00€
15391	282	13,50€	15494	178	12,50€	15723	100	2,21€	16152	89	25,10€
15392	282	17,50€	15495	178	12,50€	15724	100	2,82€	16153	89	81,00€
15393	282	12,50€	15496	178	11,50€	15725	100	1,86€	16154	89	34,10€
15394	282	26,00€	15497	178	11,00€	15726	100	2,82€	16155	89	34,10€
15395	282	3,50€	15498	178	11,50€	15730	70,76	289,00€	16156	89	12,60€
15396	300	2,04€	15499	178	11,00€	15731	70,76	214,00€	16157	89	59,00€



REF.	Pg.	PVP	REF.	Pg.	PVP	REF.	Pg.	PVP	REF.	Pg.	PVP
16158	128	9,00€	50765	308	0,58€	50935	252	595,00€	51259	193	58,00€
16160	106	3,99€	50766	308	0,68€	50937	204	10,50€	51260	25	37,00€
16161	80	17,50€	50767	308	0,78€	50942	274,288	28,00€	51261	25	36,00€
16162	80	35,10€	50768	308	0,88€	50957	295	22,00€	51262	203	51,00€
16163	80	10,20€	50771	308	0,29€	50959	295,328	12,00€	51262R	203	14,00€
16165	280	2,00€	50774	308	0,57€	50960	295	18,30€	51266	301	28,00€
16166	280	23,50€	50776	308	0,76€	50966	300,317	4,00€	51272	55	7,50€
16167	280	7,00€	50778	308	0,10€	50980	30	22,00€	51277	144	64,00€
16168	280	5,00€	50779	308	0,19€	50982	30	22,00€	51283	174	78,00€
16169	280	1,50€	50780	308	0,29€	50983	27	48,00€	51305	52	28,90€
16170	280	1,50€	50781	308	0,38€	50985	27	59,00€	51306	52	28,10€
16171	280	20,50€	50782	308	0,49€	51017	58	6,80€	51307	52	29,70€
16172	280	22,50€	50783	314	0,58€	51018	58	7,05€	51315	353	2,50€
16173	280	3,00€	50784	308	0,68€	51020	58	6,65€	51318	34	98,00€
16188	80	39,60€	50785	308	0,78€	51021	58	7,05€	51326	119	4,40€
16198	287	5,00€	50786	308	0,88€	51028	154	163,00€	51332	178	98,00€
54294	317	8,80€	50787	214	8,00€	51033	283	98,00€	51333	28	18,00€
50400	169	168,00€	50788	214	14,50€	51035	82	799,00€	51336	151	29,30€
50403	169	98,00€	50789	214	29,00€	51050	295	285,00€	51337	182	50,00€
50409	170	26,00€	50790	214	29,00€	51051	295	34,80€	51338	203	53,00€
50410	169	168,00€	50792	188	105,00€	51055	308	0,98€	51338R	203	14,00€
50431	129	3,80€	50793	188	94,00€	51056	308	0,75€	51340	245	39,30€
50517	293	129,00€	50797	256,292	490,00€	51059	175	99,00€	51341	142,214	35,00€
50518	293	169,00€	50807	207,332	38,00€	51119	187	62,00€	51347	212	9,90€
50523	129	4,70€	50808	85	77,00€	51120	210	41,00€	51349	200	37,30€
50524	129	4,70€	50815	261	88,00€	51121	211	27,30€	51352	179	9,80€
50525	300	1,00€	50816	261	88,00€	51123	196	91,00€	51353	179	11,50€
50526	300	4,80€	50818	261	198,00€	51124	197	88,00€	51354	180	13,20€
50551	130	350,00€	50819	262	28,00€	51125	196	88,00€	51355	62,310	19,00€
50560	37	38,60€	50820	262	34,50€	51126	198	18,00€	51356	258	48,00€
50561	38	19,20€	50821	262	47,00€	51127	203	56,00€	51358	312	7,50€
50562	39	23,50€	50822	262	59,00€	51127R	203	14,00€	51359	312	9,00€
50564	38	30,00€	50823	262	94,00€	51131	161	61,00€	51360	162	8,05€
50567	58	9,60€	50824	262	88,00€	51140	201,237	64,00€	51361	162	9,80€
50577	164	12,60€	50825	262	154,00€	51206	132	228,00€	51362	312	3,00€
50585	306	14,70€	50827	211,267	387,00€	51207	132	289,00€	51363	272	114,00€
50600	308	0,60€	50830	264	560,00€	51210	133	650,00€	51364	201	26,00€
50601	308	0,29€	50831	267	460,00€	51211	133	560,00€	51365	272	118,00€
50622	36	64,00€	50835	265	290,00€	51212	133	488,00€	51368	194	19,00€
50623	24	60,00€	50836	268	148,00€	51213	133	690,00€	51369	194	28,00€
50630	269	590,00€	50838	268	299,00€	51214	135	148,00€	51383	144	11,10€
50631	267	68,00€	50839	270	180,00€	51215	135	119,00€	51384	25	34,00€
50632	279	298,00€	50840	268	138,00€	51216	136	650,00€	51385	142	4,55€
50644	301	11,60€	50843	85	79,00€	51218	135	288,00€	51386	142	5,95€
50651	332	16,50€	50844	85	65,00€	51219	136	222,00€	51387	142	3,25€
50652	332	16,50€	50852	257	24,50€	51220	135	240,00€	51388	136	22,00€
50654	300,317	4,00€	50901	162	16,00€	51221	134	199,00€	51389	136	22,00€
50656	172	290,00€	50902	42	13,00€	51222	134	128,00€	51390	136	22,00€
50717	301	21,90€	50903	162	30,80€	51225	135	198,00€	51391	136	22,00€
50724	204	28,00€	50910	128	45,00€	51226	136	233,00€	51392	136	34,00€
50731	254	68,00€	50911	269	788,00€	51227	136	193,00€	51393	136	34,00€
50751	143,257	43,00€	50913	172	195,00€	51235	273	49,00€	51398N	316	1,74€
50754	36	98,00€	50915	129	4,20€	51238	272	138,00€	51400	182	17,00€
50760	308	0,10€	50916	170	0,88€	51239	272	159,00€	51401	182	22,00€
50761	308	0,19€	50917	252	271,00€	51245	137	99,00€	51402	182	20,50€
50762	308	0,29€	50918	252	341,00€	51246	303,318	6,40€	51403	182	17,50€
50763	308	0,38€	50923	167,270	454,00€	51253	252	41,00€	51405	52	21,10€
50764	308	0,49€	50924	249	342,00€	51258	119	0,15€	51406	52	29,20€

REF.	Pg.	PVP	REF.	Pg.	PVP	REF.	Pg.	PVP	REF.	Pg.	PVP
51409	25	36,00€	51656	81	3,65€	51816	273	49,00€	51967	125	16,00€
51410	25	36,00€	51657	81	5,85€	51817	300,317	4,50€	51968	125	16,00€
51412	303	2,10€	51658	81	4,50€	51818	19	95,00€	51969	124	14,00€
51414	194	14,00€	51659	36	59,00€	51819	16	48,00€	51972	57	12,00€
51416	311	12,00€	51661	53,311	12,00€	51824	170	36,80€	51973	305	45,00€
51419	81	2,79€	51674	46	7,75€	51830	204	94,00€	51975	81	2,27€
51422	81	2,97€	51680	298	2,40€	51831	276	24,00€	51976	81	1,63€
51439	136	26,00€	51681	298	4,50€	51832	162	18,00€	51978	169	84,00€
51440	136	28,00€	51691	298	2,40€	51837	280	195,00€	51980	143	15,00€
51441	136	26,00€	51692	298	3,25€	51838	280	667,00€	51981	143	21,50€
51442	136	28,00€	51693	298	3,55€	51839	176,275	24,00€	51982	293	120,00€
51443	142	5,50€	51694	298	3,55€	51842	273	6,90€	51983	293	180,00€
51444	142	5,05€	51696	298	3,55€	51843	330	0,19€	51984	293	190,00€
51445	142	5,05€	51697	300	0,80€	51853	47	18,00€	51985	170	84,00€
51447	54,80	16,00€	51703	314	10,50€	51855	23	378,00€	51986	215	11,90€
51448	54,80	52,00€	51705	314	8,45€	51858	305	15,00€	51989	216	49,00€
51452	268	69,00€	51706	313	22,80€	51859	276	3,80€	51991	195	48,00€
51456	81	550,00€	51707	313	9,05€	51861	136,314	199,00€	51995	60,61	24,50€
51479	55	31,80€	51708	313	14,20€	51863	305	54,00€	51998	190	38,00€
51488	245	16,00€	51709	313	14,70€	51864	40,78	64,00€	52009	32,289	36,00€
51489	245	12,00€	51710	313	17,80€	51886	128	44,00€	52010	198	80,00€
51490	196	36,00€	51711	313	21,20€	51889	115	49,00€	52012	205	68,00€
51491	186	154,00€	51712	313	8,65€	51890	41	92,00€	52016	187	2,10€
51493	185	68,00€	51713	313	13,10€	51893	189	690,00€	52017	187	2,40€
51494	183	107,00€	51714	313	15,80€	51895	261	99,00€	52018	187	2,60€
51495	191	59,00€	51715	313	20,30€	51896	187	82,00€	52019	187	3,20€
51496	192	8,00€	51716	313	23,60€	51897	187	122,00€	52021	187	3,40€
51500	194	29,00€	51717	313	11,20€	51898	187	139,00€	52022	187	4,50€
51501	195	38,00€	51718	313	14,80€	51899	187	137,00€	52023	187	6,60€
51504	46	8,50€	51719	313	22,00€	51901	265	999,00€	52024	187	10,60€
51525	55	9,80€	51720	313	23,50€	51902	195	84,00€	52025	187	13,00€
51526	55	9,80€	51721	313	25,00€	51905	262	34,50€	52026	162	31,80€
51528	40	49,00€	51722	313	13,10€	51906	262	39,00€	52027	324	14,00€
51529	38	59,00€	51723	313	18,70€	51907	262	48,00€	52028	326	15,20€
51546	330	0,19€	51724	313	24,40€	51908	309	44,00€	52029	326	14,00€
51554	330	0,28€	51725	313	28,30€	51909	44	2,46€	52030	329	98,00€
51573	119,302	2,50€	51726	313	31,40€	51918	46	12,50€	52031	328	44,00€
51574	84	52,00€	51727	313	49,00€	51919	205	89,00€	52032	329	28,00€
51575	84	317,00€	51737	82	699,00€	51920	215,332	18,00€	52033	333	43,00€
51576	81	125,00€	51738	82	850,00€	51923	179	12,50€	52043	327	16,50€
51600	84	109,00€	51741	311	0,50€	51925	300	1,00€	52044	325	19,00€
51604	308	0,98€	51742	311	0,50€	51927	246	25,00€	52047	129	3,30€
51612	129	5,95€	51743	311	0,55€	51928	256	14,00€	52048	129	3,95€
51613	129	2,90€	51745	316	0,70€	51929	129	22,00€	52049	48	14,00€
51614	129	3,60€	51746	30	12,00€	51930	24	39,00€	52050	61	98,00€
51615	129	5,95€	51750	269	299,00€	51934	179	11,50€	52052	58	53,00€
51616	23	378,00€	51751	270	99,00€	51935	302	135,00€	52053	335	45,00€
51622	171	25,30€	51785	316	0,75€	51936	302	135,00€	52054	335	17,00€
51632N	316	1,74€	51795	63	9,00€	51937	302	135,00€	52055	268	129,00€
51633	316	1,74€	51796	63	14,00€	51951	47	15,60€	52056	205	66,00€
51634	316	1,74€	51797	63	18,00€	51958	204	422,00€	52057	170	6,80€
51636N	316	1,54€	51798	63	39,60€	51960	124	34,00€	52058	170	4,50€
51638N	316	1,54€	51799	330	0,20€	51961	124	34,00€	52059	30	29,00€
51640N	316	1,54€	51801	53	62,00€	51962	123	25,00€	52060	30	32,00€
51642N	316	1,54€	51804	328	58,00€	51963	123	29,00€	52065	170	45,00€
51653	81	5,10€	51805	54,80	17,00€	51964	123	28,00€	52066	213	12,00€
51654	81	4,80€	51812	59	46,00€	51965	123	29,50€	52069	272	29,50€
51655	81	4,10€	51814	300	8,00€	51966	124	18,00€	52070	272	40,00€



REF.	Pg.	PVP	REF.	Pg.	PVP	REF.	Pg.	PVP	REF.	Pg.	PVP
52071	272	47,00€	52270	199	109,00€	52368	130	1,14€	52478	165	49,00€
52076	190	111,00€	52271	245	18,00€	52369	130	1,19€	52479	165	24,70€
52077	163	29,50€	52272	59	24,60€	52370	130	1,17€	52480	165	44,00€
52148	85	82,00€	52273	185	44,00€	52373	81	252,00€	52481	165	52,00€
52149	293	230,00€	52275	176	38,00€	52375	123	38,00€	52482	165	44,00€
52152	57	13,50€	52293	193	98,00€	52378	142,214	10,00€	52483	165	41,00€
52153	190	46,00€	52295	166	6,50€	52381	144	20,50€	52484	165	66,00€
52156	140	140,00€	52296	198	119,00€	52382	274,288	19,50€	52485	165	51,00€
52157	141	48,00€	52297	198	172,00€	52384	117	29,00€	52486	165	62,00€
52158	328	38,50€	52298	198	177,00€	52385	164	251,00€	52487	165	63,00€
52159	141	64,00€	52302	125	25,40€	52386	164	23,60€	52488	188	28,00€
52160	141	48,00€	52303	126	26,40€	52387	164	24,50€	52489	189	58,00€
52162	71,275,290	38,00€	52304	262	84,00€	52390	165	35,20€	52490	144	6,65€
52163	330	95,00€	52305	190	106,00€	52391	258	5,00€	52491	144	10,50€
52165	140	118,00€	52308	86	440,00€	52393	74	1.180,00€	52493	300,320	4,50€
52167	140	48,00€	52309	86	941,00€	52412	59	5,00€	52494	200	227,00€
52169	43	25,00€	52310	316	3,65€	52414	126	19,00€	52495	206	14,50€
52170	43	16,00€	52311	179	19,00€	52415	126	19,00€	52497	213	26,80€
52171	141	39,00€	52312	179	9,00€	52416	180	14,00€	52498	256	58,00€
52172	74	780,00€	52313	179	8,00€	52417	180	28,00€	52500	42	19,00€
52180	46	19,00€	52314	179	26,60€	52418	23	164,00€	52502	165	31,40€
52181	46	22,50€	52315	176	16,00€	52419	81	80,00€	52503	165	32,50€
52182	46	24,00€	52316	192	18,90€	52420	81	108,00€	52504	165	27,60€
52183	46	26,20€	52317	192	19,90€	52421	81	172,00€	52505	164	20,80€
52184	46	43,00€	52318	194	73,00€	52422	160	24,70€	52506	164	16,00€
52185	46	55,00€	52319	215	8,80€	52424	63	64,00€	52507	165	30,10€
52186	46	72,00€	52320	30	22,00€	52425	46	33,30€	52508	61	38,40€
52187	305	21,80€	52321	167	8,80€	52426	46	52,00€	52509	61	36,20€
52188	47	15,50€	52327	167	12,00€	52427	46	64,00€	52511	165	42,00€
52190	194	8,00€	52328	176	99,00€	52428	252	43,00€	52512	164	50,00€
52191	176	198,00€	52329	252	36,40€	52430	318	10,90€	52514	270	84,00€
52195	279	170,00€	52330	174	99,00€	52432	199	35,00€	52515	62,216	9,10€
52197	52	36,30€	52331	140	201,00€	52433	204	4,80€	52516	214	28,00€
52198	29	37,70€	52337	150	65,00€	52434	176	125,00€	52517	214	6,00€
52200	294	88,00€	52338	151	41,00€	52436	276	680,00€	52518	179	115,00€
52201	294	66,00€	52339	153	61,00€	52439	274	227,00€	52519	32,289	25,50€
52202	294	88,00€	52340	153	58,00€	52450	275	105,00€	52521	32,289	125,00€
52207	51	24,20€	52341	150	58,00€	52451	39	42,00€	52524	54	51,00€
52227	211	247,00€	52342	151	63,00€	52452	249	8,00€	52525	54	13,80€
52230	172	398,00€	52343	152	52,00€	52453	249	21,00€	52526	54	28,40€
52231	275	49,00€	52344	153	197,00€	52454	202	12,90€	52527	141	82,00€
52233	273	328,00€	52345	150	109,00€	52455	176	16,00€	52528	137	49,00€
52235	64	11,00€	52346	150	103,00€	52456	123	36,00€	52530	306	14,00€
52236	64	13,30€	52347	154	158,00€	52458	128	58,00€	52533	166	10,00€
52237	64	18,10€	52348	154	179,00€	52460	47	16,60€	52534	306	15,00€
52238	64	24,90€	52349	64	22,10€	52461	47	25,70€	52535	306	16,50€
52241	265	1.690,00€	52350	64	22,60€	52462	49	25,30€	52536	114	57,00€
52242	258	12,00€	52351	64	25,40€	52463	49	26,10€	52538	28	62,00€
52243	258	8,50€	52352	64	32,40€	52464	49	42,00€	52539	28	59,00€
52244	169	84,00€	52353	64	33,40€	52466	214	11,00€	52540	171	221,00€
52251	305	21,80€	52354	64	34,40€	52467	214	10,30€	52541	196	45,00€
52254	120	64,00€	52355	64	36,60€	52468	55	5,90€	52542	85	109,00€
52259	300	3,75€	52357	64	54,00€	52472	55	4,90€	52543	143	182,00€
52262	166	7,50€	52358	64	63,00€	52473	55	9,90€	52544	154	93,00€
52263	166	13,50€	52362	130	1,23€	52474	165	68,00€	52545	154	177,00€
52264	166	18,60€	52363	130	1,23€	52475	165	62,00€	52546	153	39,60€
52265	166	30,50€	52364	130	2,86€	52476	165	50,00€	52547	150	96,00€
52269	180	7,00€	52365	130	2,46€	52477	165	70,00€	52550	27	92,00€

REF.	Pg.	PVP	REF.	Pg.	PVP	REF.	Pg.	PVP	REF.	Pg.	PVP
52551	201	151,00€	52642	196	32,00€	52729	198	128,00€	52813	185	79,00€
52552	313	128,00€	52643	278	596,00€	52730	198	288,00€	52814	134	528,00€
52555	119	2,38€	52644	314	8,80€	52731	198	38,00€	52815	190	110,00€
52558	119	2,38€	52645	313	0,55€	52732	198	58,00€	52816	190	28,10€
52565	46	11,50€	52646	313	0,50€	52733	198	98,00€	52817	190	23,50€
52566	125	28,00€	52648	143	9,00€	52734	210	51,00€	52818	310	148,00€
52567	125	29,00€	52649	311	5,00€	52735	148	4,85€	52819	246	22,00€
52568	126	28,00€	52650	311	5,00€	52736	148	5,35€	52821	183	28,80€
52569	126	28,00€	52652	310	2,80€	52737	148	5,50€	52822	186	32,00€
52570	316	2,60€	52653	310	3,00€	52738	316	5,00€	52823	191	124,00€
52571	316	2,60€	52655	312	39,70€	52739	316	5,00€	52827	124	46,00€
52572	316	2,60€	52656	312	39,50€	52740	120	690,00€	52828	124	43,00€
52573	316	2,60€	52657	312	37,50€	52742	305	64,00€	52829	314	19,00€
52574	137	69,00€	52658	312	39,70€	52749	168	79,00€	52830	47	24,00€
52575	50,137	119,00€	52659	312	39,70€	52753	27	107,00€	52831	47	18,00€
52583	204	8,50€	52660	313	126,00€	52754	188	54,00€	52832	193	75,00€
52587	52	39,90€	52661	313	290,00€	52757	216	16,00€	52833	192	39,30€
52588	52	45,00€	52662	310	36,50€	52758	139	88,00€	52834	199	195,00€
52589	166	13,00€	52663	310	30,00€	52760	62,216	4,10€	52835	199	272,00€
52591	211	12,00€	52664	312	168,00€	52761	57	8,00€	52836	120	1.100,00€
52592	211	22,00€	52665	308	0,37€	52762	57	9,00€	52838	128	56,00€
52593	211	34,00€	52666	308	0,36€	52765	166	21,70€	52839	64, 128	64,00€
52595	49	64,00€	52667	308	0,76€	52768	299	13,80€	52842	311	11,00€
52596	49	114,00€	52668	308	1,49€	52769	299	14,50€	52843	124	31,60€
52597	49	146,00€	52669	308	2,22€	52770	299	23,00€	52845	270	170,00€
52598	106,281	1.080,00€	52670	308	2,95€	52771	299	23,40€	52846	59	37,80€
52599	189	230,00€	52671	308	3,70€	52772	299	13,90€	52847	59	41,00€
52600	287	884,00€	52672	308	4,45€	52773	299	14,60€	52848	128	88,00€
52601	252	397,00€	52673	310	18,00€	52774	299	14,80€	52849	202	8,50€
52603	26	74,00€	52675	139	84,00€	52775	299	15,20€	52850	210	7,80€
52604	26	78,00€	52676	139	98,00€	52776	299	13,80€	52851	163,343	9,65€
52605	26	76,00€	52677	180	17,00€	52777	299	15,50€	52852	62	6,80€
52606	26	88,00€	52678	180	18,00€	52778	299	14,60€	52857	351	7,50€
52607	181	49,00€	52685	188	88,00€	52779	299	17,10€	52858	184	298,00€
52608	181	44,00€	52687	208	168,00€	52780	299	13,90€	52862	130	1,15€
52609	50	29,00€	52690	193	54,00€	52781	299	14,60€	52864	130	1,20€
52615	179	112,00€	52691	192	54,00€	52782	299	14,80€	52866	130	0,25€
52616	246	44,00€	52692	268	129,00€	52783	299	15,20€	52869	86	52,00€
52617	182	7,00€	52693	210	24,50€	52786	56	14,60€	52870	86	100,00€
52618	301	29,00€	52694	150	49,00€	52787	144	9,00€	52871	86	248,00€
52619	61	23,10€	52696	210	12,00€	52788	162	39,00€	52873	204	11,00€
52620	213	8,80€	52697	210	16,00€	52789	256	15,20€	52874	195	82,00€
52621	215	11,00€	52699	196	22,00€	52791	60,61	18,00€	52875	195	79,00€
52624	194	28,00€	52700	192	20,50€	52794	204	28,00€	52876	160	182,00€
52625	62,176	9,00€	52703	327	22,00€	52795	300	5,80€	52877	56	15,80€
52626	196	46,00€	52711	327	27,50€	52796	205	98,00€	52878	56	11,20€
52627	196	120,00€	52713	19	89,00€	52797	255	198,00€	52879	56	10,10€
52628	256	26,50€	52714	29	15,70€	52798	144	18,00€	52880	53,311	42,00€
52629	184	99,00€	52715	29	10,00€	52801	186,256	26,00€	52881	53,311	17,00€
52633	310	1,00€	52716	29	15,90€	52802	191	54,00€	52882	160	14,00€
52634	81	5,25€	52717	29	11,00€	52804	248	343,00€	52883	116	38,00€
52635	81	4,80€	52718	141	48,00€	52805	248	426,00€	52884	273	73,00€
52636	174	114,00€	52719	330	0,19€	52806	248	742,00€	52885	62	18,00€
52637	202	48,00€	52722	18	87,00€	52807	248	1.714,00€	52886	336	18,00€
52638	62	9,95€	52724	138	381,00€	52809	179	8,50€	52887	336	22,00€
52639	195	123,00€	52725	138	349,00€	52810	153	9,00€	52888	341	24,00€
52640	195	52,00€	52727	198	34,60€	52811	153	9,90€	52889	338	19,00€
52641	195	55,00€	52728	198	68,00€	52812	61	65,00€	52890	339	22,00€



REF.	Pg.	PVP	REF.	Pg.	PVP	REF.	Pg.	PVP	REF.	Pg.	PVP
52891	339	28,00€	52957	57	23,80€	53058	200	193,00€	53141	137	68,00€
52892	338	22,00€	52958	57	28,20€	53059	201	52,00€	53144	257	18,00€
52893	339	26,00€	52959	57	42,00€	53060	151	34,90€	53145	278	39,20€
52894	338	22,00€	52960	57	46,00€	53062	197	99,00€	53146	198	30,50€
52895	340	22,00€	52962	190	42,00€	53063	144	36,70€	53147	142	41,00€
52896	336	26,00€	52963	254	49,00€	53064	144	37,40€	53150	309	24,00€
52897	340	38,00€	52964	58	9,45€	53065	144	36,90€	53151	127	14,00€
52898	340	36,00€	52965	58	9,20€	53066	144	61,00€	53154	31,288	462,00€
52899	337	34,00€	52966	58	9,45€	53067	144	61,00€	53156	29	26,20€
52900	337	34,00€	52967	58	9,40€	53068	144	63,00€	53159	20	289,00€
52901	337	34,00€	52969	151	20,70€	53069	183	98,00€	53162	278	60,00€
52902	287	970,00€	52973	38	59,00€	53070	64	16,20€	53164	32,289	16,50€
52903	287	1.100,00€	52977	162	137,00€	53071	64	26,10€	53165	32,289	19,60€
52904	204	61,00€	52980	279	480,00€	53072	64	31,60€	53166	283	10,50€
52905	56	28,00€	52982	164	53,00€	53073	64	50,00€	53167	283	12,50€
52906	175	38,00€	52985	267	598,00€	53074	15	78,00€	53168	283	19,00€
52908	29	17,00€	52987	116	20,00€	53077	152	62,00€	53177	299	11,90€
52909	29	12,50€	52991	258	10,50€	53078	249	18,00€	53178	299	12,20€
52910	124	39,00€	52992	258	18,00€	53079	168	89,00€	53179	299	12,20€
52912	40,78	91,00€	52998	166	48,00€	53080	168	99,00€	53180	299	12,20€
52913	203	292,00€	52999	266	168,00€	53081	203	115,00€	53181	299	11,90€
52914	156	223,00€	53001	206	242,00€	53082	203	148,00€	53182	299	12,20€
52915	156	199,00€	53007	130	0,42€	53083	48	64,00€	53183	299	12,70€
52916	156	218,00€	53008	179	15,50€	53084	30	24,00€	53184	299	12,20€
52917	156	122,00€	53009	184	42,00€	53085	119	30,00€	53185	299	13,20€
52918	156	146,00€	53010	42	18,00€	53086	216	9,00€	53186	299	13,20€
52919	156	181,00€	53017	34	57,00€	53087	299	11,20€	53187	258	39,00€
52920	156	155,00€	53018	36	119,00€	53088	299	11,50€	53188	258	7,00€
52921	156	117,00€	53025	44	3,50€	53089	299	11,50€	53189	284	128,00€
52922	156	180,00€	53026	44	5,80€	53090	299	11,50€	53190	284	98,00€
52923	156	59,00€	53027	44	9,00€	53091	299	10,20€	53191	171	14,80€
52924	157	52,00€	53028	275	5,80€	53092	299	10,30€	53192	171	52,00€
52925	157	176,00€	53029	275	6,80€	53093	299	10,30€	53196	213	33,00€
52926	157	201,00€	53030	275	12,00€	53094	299	10,20€	53197	152	46,00€
52927	157	59,00€	53031	86	59,00€	53095	48	20,50€	53198	258	9,50€
52928	157	172,00€	53032	86	126,00€	53096	216	28,80€	53200	263	69,00€
52929	157	185,00€	53033	305	21,50€	53102	17	36,00€	53202	145	15,70€
52930	157	117,00€	53037	313	0,50€	53104	25	34,00€	53203	130	0,46€
52931	157	45,00€	53038	313	0,50€	53105	25	37,00€	53204	145	81,00€
52932	157	45,00€	53039	313	0,50€	53106	19	99,00€	53205	144	19,00€
52933	157	194,00€	53040	313	0,50€	53108	18	92,00€	53206	180	38,20€
52934	158	102,00€	53041	187	37,60€	53110	163,343	27,30€	53207	191	118,00€
52935	158	94,00€	53042	204	9,90€	53111	277	19,00€	53208	191	126,00€
52936	158	199,00€	53043	152	53,00€	53112	260	298,00€	53209	273	8,50€
52937	158	265,00€	53044	153	121,00€	53118	211	231,00€	53210	64	48,00€
52938	158	199,00€	53045	126	35,00€	53119	160	52,00€	53211	85	75,00€
52939	158	28,00€	53046	126	39,00€	53120	48	6,00€	53212	14	149,00€
52940	158	235,00€	53047	126	330,00€	53121	48	7,35€	53214	248	285,00€
52941	158	70,00€	53048	126	89,00€	53122	48	9,50€	53215	257	19,00€
52942	158	105,00€	53049	125	89,00€	53124	167	287,00€	53216	115	49,00€
52943	158	75,00€	53051	126	158,00€	53125	167	477,00€	53217	116	47,00€
52944	158	110,00€	53052	126	158,00€	53126	169	243,00€	53218	263	26,00€
52945	158	281,00€	53053	194	12,00€	53127	30	12,00€	53219	16	49,00€
52952	274,288	74,00€	53054	216	6,00€	53129	200	84,00€	53220	279	260,00€
52953	142	38,00€	53055	215	33,00€	53134	169	144,00€	53221	301	4,75€
52955	57	19,80€	53056	200	127,00€	53137	137	38,00€	53222	84	57,00€
52956	57	19,60€	53057	206	149,00€	53140	138	98,00€	53224	160	142,00€

REF.	Pg.	PVP	REF.	Pg.	PVP	REF.	Pg.	PVP	REF.	Pg.	PVP
53225	55	3,50€	53297	233	45,00€	53366	326	14,00€	53443	300	7,55€
53226	171	14,90€	53298	234	91,00€	53367	334	9,50€	53444	22	195,00€
53227	119	28,00€	53299	234	291,00€	53368	334	9,00€	53445	189	17,10€
53229	329	38,70€	53300	234	41,00€	53369	326	14,00€	53449	143	14,00€
53230	163	19,70€	53301	235	44,00€	53370	324	26,00€	53450	143	28,30€
53232	163	39,00€	53302	236	44,00€	53371	325	29,00€	53452	234	26,50€
53235	182	10,40€	53303	236	89,00€	53372	324	26,00€	53453	254	7,00€
53236	182	11,50€	53304	236	279,00€	53373	331	14,50€	53456	207	98,00€
53237	182	12,90€	53305	236	136,00€	53374	332	10,00€	53459	207	66,00€
53238	182	18,40€	53306	240	53,00€	53376	332	10,50€	53463	202	98,00€
53240	212	58,00€	53307	237	38,50€	53377	328	20,00€	53464	184,330	153,00€
53241	306	9,00€	53308	241	55,00€	53378	334	13,00€	53468	54	8,50€
53246	269	1.144,00€	53309	240	285,00€	53380	335	11,50€	53469	73	613,00€
53249	212	192,00€	53310	239	498,00€	53381	331	14,50€	53470	154	176,00€
53250	197	85,00€	53311	238	97,00€	53382	331	11,00€	53472	182	12,00€
53251	210	88,00€	53312	239	127,00€	53383	331	11,50€	53473	182	36,00€
53253	107	98,00€	53313	238	139,00€	53384	196	165,00€	53474	212	94,00€
53256	309	34,00€	53314	238	98,00€	53385	56,343	19,30€	53477	213	36,10€
53258	107	67,00€	53315	244	285,00€	53388	198	90,00€	53478	54	4,55€
53259	218	97,00€	53316	237	34,00€	53389	58	31,50€	53479	54	6,40€
53260	218	168,00€	53317	246	34,00€	53390	60	34,50€	53480	54	19,90€
53261	218	214,00€	53318	245	24,00€	53391	199	86,00€	53481	54	27,40€
53262	218	251,00€	53319	240	18,00€	53393	199	118,00€	53484	276	615,00€
53263	219	57,00€	53320	245	12,00€	53394	211	598,00€	53485	209	140,00€
53264	220	143,00€	53321	246	10,50€	53395	213	16,00€	53486	160	29,30€
53265	219	195,00€	53324	233	12,50€	53396	60	18,30€	53487	61	16,70€
53266	220	224,00€	53325	246	7,50€	53399	45	3,50€	53488	194	61,00€
53267	220	277,00€	53326	226	16,00€	53400	45	5,70€	53489	188	68,00€
53268	221	92,00€	53327	226	11,00€	53401	45	7,40€	53490	189	275,00€
53269	220	50,00€	53328	191	76,00€	53402	45	9,60€	53492	142,353	380,00€
53270	222	70,00€	53330	186	38,00€	53403	45	6,50€	53499	207	29,00€
53271	222	227,00€	53331	50	31,80€	53404	45	6,50€	53500	207	29,00€
53272	222	195,00€	53332	50	34,50€	53405	45	5,30€	53501	184	24,00€
53273	223	75,00€	53339	47	9,50€	53406	45	8,55€	53502	192	38,70€
53274	225	30,50€	53340	329	86,00€	53407	45	12,70€	53503	275	12,00€
53275	228	35,50€	53343	137	285,00€	53408	45	19,30€	53504	351	38,00€
53276	225	160,00€	53344	137	295,00€	53409	45	9,00€	53505	120	77,00€
53277	223	45,00€	53346	52	18,00€	53410	206	92,00€	53506	120	36,00€
53278	224	143,00€	53347	209	100,00€	53411	56	5,00€	53507	302	24,00€
53279	226	97,00€	53348	324	14,00€	53412	56	4,00€	53508	302	14,00€
53280	226	112,00€	53349	324	14,00€	53414	162	49,00€	53509	73	482,00€
53281	225	55,00€	53350	324	14,00€	53415	162	188,00€	53510	351	24,00€
53282	225	48,00€	53351	325	12,50€	53416	143	14,10€	53511	351	23,00€
53283	227	92,00€	53352	325	12,00€	53417	143	26,30€	53512	351	41,00€
53284	224	306,00€	53353	331	18,00€	53418	143	16,90€	53513	351	9,00€
53285	227	56,00€	53354	326	14,00€	53419	311	9,70€	53514	73	990,00€
53286	227	87,00€	53355	334	11,50€	53420	40	72,00€	53517	56	9,50€
53287	227	245,00€	53356	334	11,50€	53421	260	298,00€	53518	249	3,50€
53288	228	72,00€	53357	272,334	7,00€	53422	260	368,00€	53519	114	42,00€
53289	229	45,00€	53358	334	11,50€	53423	269	199,00€	53520	132	228,00€
53290	229	51,00€	53359	333	16,00€	53426	188	39,80€	53522	184	24,00€
53291	229	68,00€	53360	327	18,00€	53427	119	5,00€	53523	229	91,00€
53292	230	116,00€	53361	327	24,00€	53428	125	18,00€	53524	63	51,00€
53293	231	134,00€	53362	326	14,00€	53429	125	18,00€	53525	213	12,00€
53294	233	119,00€	53363	325	34,00€	53430	158	286,00€	53526	283,292	168,00€
53295	232	77,00€	53364	325	16,00€	53434	333	18,00€	53530	116,208	46,00€
53296	233	60,00€	53365	327	14,00€	53441	179	9,80€	53531	150	109,00€



REF.	Pg.	PVP	REF.	Pg.	PVP	REF.	Pg.	PVP	REF.	Pg.	PVP
53532	146,292	119,00€	53603	57	45,00€	53662	209	89,00€	53727	23	198,00€
53533	350	1,50€	53604	57	118,00€	53663	212	8,00€	53728	23	198,00€
53536	129	34,00€	53605	312	141,00€	53664	194	38,00€	53729	213	19,10€
53537	181	14,50€	53606	145	55,00€	53665	215	19,00€	53733	132	238,00€
53538	181	14,50€	53607	145	292,00€	53666	215	28,00€	53734	114	23,70€
53539	208	78,00€	53608	132	98,00€	53667	30	32,00€	53735	181	44,00€
53540	298	23,00€	53609	250	190,00€	53668	30	34,00€	53736	168	98,00€
53541	138	168,00€	53610	250	294,00€	53669	206	45,00€	53737	41	12,50€
53542	138	980,00€	53611	144	27,50€	53670	180	29,50€	53738	41	10,90€
53543	284	13,80€	53612	249	96,00€	53671	51,79	41,00€	53739	41	10,50€
53545	163	35,70€	53613	44	19,50€	53672	83	440,00€	53740	41	9,10€
53547	58	14,70€	53614	44	21,50€	53673	161	80,00€	53741	181	14,00€
53548	58	15,60€	53615	44	34,60€	53674	82	447,00€	53743	28,154	39,70€
53549	58	14,30€	53616	44	10,40€	53675	164	50,00€	53744	151	63,00€
53550	58	14,70€	53617	44	9,25€	53676	164	44,00€	53745	307	6,40€
53551	317	18,95€	53618	44	13,90€	53677	164	55,00€	53746	307	6,40€
53552	317	18,95€	53620	80	88,00€	53678	164	52,00€	53747	307	6,40€
53553	317	18,95€	53621	298	2,50€	53681	134	743,00€	53748	307	6,60€
53556	73	990,00€	53622	298	2,50€	53682	268	98,00€	53749	307	6,70€
53557	73	990,00€	53623	298	2,50€	53683	174	116,00€	53750	307	6,70€
53561	302	28,00€	53624	298	2,50€	53684	266	1.880,00€	53751	307	6,80€
53565	84	258,00€	53625	141	68,00€	53685	168	310,00€	53752	307	6,95€
53566	254	32,00€	53626	140,161	18,00€	53686	69	890,00€	53753	307	7,10€
53567	136,166	43,00€	53627	254	22,50€	53687	272	298,00€	53754	307	7,40€
53568	118	12,00€	53629	147	14,30€	53688	272	495,00€	53755	307	7,50€
53569	118	18,00€	53630	147	18,80€	53689	133	238,00€	53756	307	7,90€
53570	121	154,00€	53631	147	33,50€	53690	122	34,00€	53757	307	7,90€
53572	138,210	348,00€	53632	147	46,00€	53691	122	36,00€	53758	307	8,20€
53573	141	36,00€	53633	147	46,00€	53693	314	521,00€	53759	307	8,50€
53574	28,42	47,00€	53634	147	63,00€	53694	42	18,40€	53760	307	9,60€
53575	43	16,00€	53635	202	85,00€	53695	314	504,00€	53761	69	680,00€
53576	139	189,00€	53636	302	22,00€	53696	215	22,00€	53762	69	680,00€
53577	73	990,00€	53637	210	85,00€	53697	250	398,00€	53763	68	890,00€
53578	73	990,00€	53638	202	243,00€	53698	314	717,00€	53764	68	680,00€
53579	73	990,00€	53639	63	28,60€	53701	197	188,00€	53765	68	890,00€
53580	73	990,00€	53640	63	34,40€	53702	107	28,50€	53766	68	680,00€
53581	146,292	115,00€	53641	63	41,00€	53703	107	41,00€	53767	69	890,00€
53582	146,292	179,00€	53642	63	54,00€	53704	107	42,00€	53768	69	680,00€
53583	146,292	170,00€	53643	63	92,00€	53705	170	80,00€	53769	72,230	178,00€
53584	283,292	119,00€	53644	251	1.238,00€	53706	224	98,00€	53770	72,242	198,00€
53585	283,292	168,00€	53645	251	268,00€	53707	121	153,00€	53771	72,243	158,00€
53586	283,292	158,00€	53646	139,140,161	62,00€	53708	66,68 69,74,76	325,00€	53772	72,243	229,00€
53587	151	44,00€	53647	14	96,00€	53710	344	16,00€	53773	72,241	298,00€
53588	132	164,00€	53648	224	107,00€	53711	344	16,00€	53774	72,242	190,00€
53589	62	12,00€	53649	228	89,00€	53712	344	16,00€	53775	72,244,245	1.109,00€
53590	266	1.190,00€	53650	186	47,00€	53713	343	16,00€	53776	116	19,10€
53591	56	5,50€	53651	235	91,00€	53714	343	16,00€	53777	270	4.352,00€
53592	257	25,00€	53652	191	53,00€	53715	343	19,00€	53778	300	4,50€
53593	145	41,00€	53653	231	207,00€	53716	342	19,00€	53779	263	36,00€
53594	147	54,00€	53654	63	81,00€	53717	342	19,00€	53780	117	14,50€
53595	147	61,00€	53655	213	12,00€	53718	342	19,00€	53781	319	18,00€
53596	318	3,65€	53656	278	198,00€	53719	341	19,00€	53782	107	14,00€
53597	318	3,70€	53657	278	248,00€	53720	341	19,00€	53784	135	148,00€
53598	318	3,95€	53658	278	99,00€	53723	309	68,00€	53785	318	4,80€
53599	207,331	30,30€	53659	278	121,00€	53724	276	46,00€	53786	322	98,00€
53600	284	13,80€	53660	279	146,00€	53725	260	248,00€	53787	319	0,98€
53602	57	30,50€	53661	69	890,00€	53726	133	128,00€	53787O	319	0,98€
									53791	320	4,80€

REF.	Pg.	PVP	REF.	Pg.	PVP	REF.	Pg.	PVP	REF.	Pg.	PVP
53794	320	28,00€	53877	352	430,50€	53951	72,245	1.794,00€	54023	51	13,50€
53796	322	76,00€	53878	352	574,00€	53952	72,245	1.794,00€	54024	51	17,90€
53797	319	0,10€	53879	352	838,50€	53953	16	29,00€	54028	50	28,00€
53798	320	1,95€	53880	270	598,00€	53954	41	8,50€	54029	50	28,00€
53802	322	120,00€	53881	146,292	79,00€	53955	41	10,00€	54030	50	18,80€
53803	320	0,90€	53882	146,292	79,00€	53956	348	353,00€	54031	50	19,30€
53804	320	0,80€	53883	53	18,40€	53957	319	0,26€	54032	35	84,00€
53805	322	220,00€	53884	53	30,20€	53958	214	6,50€	54033	136	49,00€
53806	322	250,00€	53885	53	35,70€	53959	319	0,98€	54034	7	178,00€
53808	321	16,50€	53886	53	20,30€	53960	319	0,98€	54035	10	149,00€
53809	321	8,00€	53887	53	30,30€	53961	319	0,98€	54036	11	99,00€
53811	321	8,90€	53888	53	37,90€	53964	305	9,65€	54037	12	88,00€
53812	321	23,50€	53893	319	5,00€	53965	305	25,80€	54038	13	88,00€
53820	280	388,00€	53895	262	107,00€	53967	60	10,20€	54039	122	154,00€
53822	320	2,50€	53896	262	127,00€	53968	261	49,00€	54040	274	240,00€
53824	320	2,85€	53897	262	140,00€	53969	268	96,00€	54041	35	198,00€
53826	319	16,00€	53898	262	148,00€	53970	286	3.790,00€	54042	303,318	13,00€
53827	320	14,00€	53900	68,80	890,00€	53971	286	468,00€	54043	349	48,00€
53828	320	6,00€	53901	68,80	680,00€	53972	203	550,00€	54044	127	99,00€
53829	320	14,00€	53902	319,320	25,00€	53973	348	284,00€	54045	7	179,00€
53830	320	1.300,00€	53903	214	59,00€	53974	117	38,00€	54046	10	150,00€
53832	320	1,81€	53904	69,80	890,00€	53976	60	9,00€	54047	11	100,00€
53835	321	16,00€	53905	60	7,30€	53977	277	17,50€	54048	12	89,00€
53836	321	16,00€	53906	60	8,65€	53978	175	38,90€	54049	13	88,00€
53838	322	38,00€	53908	60	7,25€	53979	40,80	34,60€	54050	255	980,00€
53839	321	0,25€	53909	60	9,70€	53980	40,80	34,60€	54051	257	39,00€
53840ES	321	6,00€	53910	333	19,00€	53981	277	143,00€	54052	287	1.100,00€
53844	319	2,80€	53911	60	8,80€	53982	277	219,00€	54053	287	248,00€
53845	263	64,00€	53912	67	1.280,00€	53983	167	215,00€	54054	287	268,00€
53849	256	16,10€	53913	67	1.280,00€	53984	317	8,80€	54055	287	220,00€
53850	93,109	14,90€	53914	321,354	75,00€	53985	317	8,80€	54056	287	260,00€
53851	110	88,00€	53915	24,210	65,00€	53986	317	8,80€	54057	287	248,00€
53852	92,110	207,00€	53916	319	3,80€	53987	288,321	9,50€	54058	287	348,00€
53853	110	14,40€	53917	42	9,00€	53988	152	101,00€	54059	287	428,00€
53854	110	27,00€	53919	304	81,00€	53992	333	18,00€	54060	42	6,00€
53855	110	24,80€	53921	169	39,00€	53993	48	77,00€	54061	42	6,00€
53856	92,110	62,00€	53922	169	29,00€	53997	189	48,00€	54066	34,78	83,00€
53857	91,92,111	27,00€	53927	273	66,00€	53999	111	2,00€	54067	286	599,00€
53858	91,92,111	28,80€	53928	21	278,00€	54000	111	2,50€	54068	178	198,00€
53859	92,111	67,00€	53929	273	95,00€	54001	264	285,00€	54069	202	29,50€
53860	92,109	3,65€	53930	350	276,00€	54002	111	3,00€	54070	43	18,00€
53861	92,109	5,45€	53931	351	104,00€	54003	187	104,00€	54071	43	26,50€
53862	254,319	6,00€	53932	57	8,00€	54004	118	23,00€	54072	303,318	38,50€
53863	254,319	3,00€	53934	351	690,00€	54005	41	14,00€	54073	304	70,00€
53864	309	138,00€	53939	66	1.280,00€	54006	69,71	680,00€	54074	304	18,50€
53865	348	48,00€	53940	71,288 290,321	13,20€	54008	111	3,50€	54076	349	9,00€
53866	75	424,00€	53941	71,288 290,321	6,05€	54010	111	4,50€	54078	125	68,00€
53867	74,80	1.095,00€	53942	71,288 290,321	0,50€	54011	111	5,00€	54079	37	83,00€
53868	66,80	1.090,00€	53943	43,77	21,50€	54013	309	35,00€	54081	39	28,00€
53869	67,80	990,00€	53944	43,77	19,50€	54015	60	10,20€	54082	9	188,00€
53870	67,80	990,00€	53945	43,77	18,90€	54016	209	76,00€	54083	51	9,75€
53871	35	60,00€	53946	319	0,83€	54017	166	12,00€	54084	51	13,10€
53872	292	118,00€	53947	282	145,00€	54018	51	9,85€	54085	51	17,80€
53873	253	285,00€	53948	282	324,00€	54019	51	17,90€	54086	51	9,25€
53874	253	398,00€	53949	351	4,50€	54020	349	288,00€	54087	51	17,30€
53875	246	134,00€	53950	351	4,50€	54021	51	13,50€	54088	122	132,00€
53876	238	64,00€				54022	51	9,95€	54089	48	17,50€



REF.	Pg.	PVP	REF.	Pg.	PVP	REF.	Pg.	PVP	REF.	Pg.	PVP
54090	24	56,00€	54159	39	47,00€	54217	235	104,00€	60012	108	48,00€
54091	31,288	441,00€	54160L	127	17,50€	54218	228	142,00€	60013	108	80,00€
54092	223	24,00€	54160R	127	17,50€	54219	221	60,00€	60015	108	138,00€
54093	31	441,00€	54161	127	90,00€	54220	187,222	197,00€	60016	108	49,00€
54097	37	38,90€	54162	127	81,00€	54221	235	111,00€	60017	108	64,00€
54099	48	13,80€	54163	127	80,00€	54222	219	59,00€	60018	88	306,00€
54100	251	265,00€	54164	25	34,00€	54223	231	149,00€	60019	95	178,00€
54101	34	61,00€	54166	304	32,40€	54224	231	64,50€	60020	94	175,00€
54102	297	60,00€	54168	15	49,00€	54225	230	133,00€	60022	97	470,00€
54105	15	33,00€	54169	304	13,80€	54226	244	71,00€	60023	93	212,00€
54106	18,41	89,00€	54170	304	16,50€	54227	221	122,00€	60024	91	190,00€
54108	18	66,00€	54171	350	138,00€	54228	219	187,00€	60025	91,108	31,60€
54109	17	34,00€	54172	123	81,00€	54229	281	48,00€	60026	91,108	37,90€
54110	35	46,00€	54173	123	87,00€	54230	281	68,00€	60027	103	99,00€
54111	163	4,75€	54174	37	139,00€	54231	281	138,00€	60028	92	142,00€
54112	163,197	18,00€	54175	270	34,00€	54232	281	248,00€	60029	104	240,00€
54113	163	7,65€	54176	293	188,00€	54233	290	1.856,00€	60030	105	112,00€
54114	71	248,00€	54177	317	18,95€	54234	71,290	1.856,00€	60031	104	142,00€
54115	39	26,80€	54178	317	18,95€	54235	71,290	1.856,00€	60032	99	123,00€
54116	17	66,00€	54179	317	18,95€	54236	71/290	1.856,00€	60033	93	104,00€
54117	34	74,00€	54180	296	2.400,00€	54237	70	1.887,00€	60034	90	320,00€
54119	39	78,00€	54181	249	25,10€	54238	70	1.887,00€	60035	102	30,00€
54120	37	59,00€	54182	249	34,70€	54239	70	1.887,00€	60037	98	222,00€
54122	115	38,00€	54183	249	38,20€	54240	70	1.887,00€	60038	99	255,00€
54123	115	40,00€	54184	249	44,00€	54241	71,290	120,00€	60039	103	265,00€
54124	115	47,00€	54185	296	390,00€	54245	183	580,00€	60040	105	440,00€
54125	284	152,00€	54186	183	580,00€	54246	294	104,00€	60041	98	77,00€
54126	43	39,00€	54187	37	39,30€	54247	294	99,00€	60042	100	106,00€
54128	104	10,50€	54188	316	19,00€	54248	145	58,00€	60043	100	123,00€
54129	71,290	110,00€	54189	316	19,00€	54249	145	103,00€	60044	89	478,00€
54130	71,290	58,00€	54190	316	19,00€	54250	8	188,00€	60044C	89	652,00€
54131	290	58,00€	54191	316	19,00€	54251	139	43,00€	60045	106	298,00€
54132	71,290	190,00€	54192	316	8,90€	54252	280	199,00€	70002	346	37,50€
54133	122	547,00€	54193	316	8,90€	54253	191	166,00€	70003	346	37,50€
54134	70	1.415,00€	54194	316	8,90€	54254	57	43,00€	70005	346	42,00€
54135	176	82,00€	54195	316	8,90€	54255	257	68,00€	70009	346	37,50€
54136	312	107,00€	54196	297	133,00€	54256	275	48,00€	70011	346	42,00€
54137	260	288,00€	54197	297	118,00€	54257	183,264	318,00€	70012	346	42,00€
54139	188	147,00€	54198	312	59,00€	54260	231	119,00€	70013	346	44,00€
54140	17	36,00€	54199	226	94,00€	54262	267	88,00€	70014	346	44,00€
54141	24	42,00€	54200	244	56,00€	54263	267	130,00€	70015	346	44,00€
54142	62	15,20€	54201	232	37,60€	54264	267	240,00€	70016	346	44,00€
54143	263	249,00€	54202	239	68,00€	54265	287	1.290,00€	70017	346	44,00€
54144	263	298,00€	54203	239	91,00€	54267	118	9,50€	90003	143	35,20€
54145	263	377,00€	54204	232	124,00€	54270	121	42,00€	90004	143	25,80€
54146	263	492,00€	54205	237	49,00€	54271	121	54,00€	JBMW-BEXP	307	24,50€
54147	263	198,00€	54206	221	113,00€	54299	201	227,00€	METEXP	306,346,353	62,00€
54149	38	60,00€	54207	223	38,90€	60001	101	88,00€	SERIE124	314	710,00€
54150	38	23,50€	54208	232	76,00€	60003	101	110,00€	SERIE262	140,161	199,00€
54151	317	10,90€	54209	232	29,70€	60004	102	79,00€			
54152	317	10,90€	54210	230	84,00€	60005	91	132,00€			
54153	317	10,90€	54211	231	74,00€	60006	92	182,00€			
54154	25	37,50€	54212	240	39,40€	60007	96	170,00€			
54155	317	8,80€	54213	238	19,80€	60008	92	141,00€			
54156	317	8,80€	54214	237	96,00€	60009	94	168,00€			
54157	317	8,80€	54215	241	57,00€	60010	95	170,00€			
54158	77	38,00€	54216	234	49,00€	60011	96	175,00€			

# INSCREVA-SE NA JBM

Enviamos as novidades da JBM em formato impresso ou digital para que você fique por dentro dos nossos avanços no setor.



**Todas as novidades  
a um click!**

## NOVIDADES

Consulte o nosso folheto semanal para estar atualizado sobre as últimas notícias a respeito do stock da JBM. Novos produtos, ofertas, substituições... Todas as novidades!

## BOLETIM DE NOTÍCIAS

Não perca nenhuma oferta do JBM! Receba o nosso boletim semanal com todas as últimas notícias e actualizações de stock. Inscreva-se agora!

## WHATSAPP

Seja o primeiro a saber das últimas promoções. Agora a novidade no seu WhatsApp!



Contacte-nos e informá-lo-emos sobre como se registar em qualquer um dos nossos canais de comunicação.

[jbm@jbmcamp.com](mailto:jbm@jbmcamp.com)

+34 972 40 57 21 / +34 972 24 55 33



+34 680 240 104



Todas as nossas  
promoções e  
novidades a um click

Peças soltas de qualquer  
produto JBM conforme  
disponibilidade

Encontre o seu kit de bloqueio  
com o código OEM

Encomendas diretas ao seu  
distribuidor

Baixe os nossos catálogos e folhetos  
diretamente no seu telemóvel

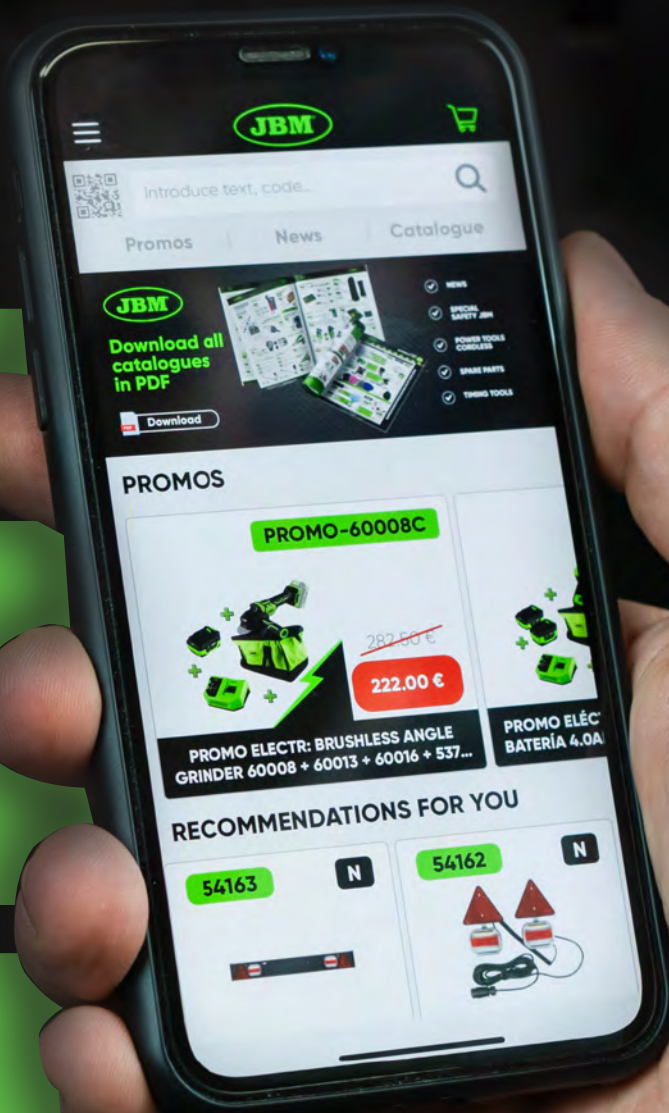



**JBM MAIS  
PERTO DE VOCÊ  
BAIXE NOSSO APLICATIVO**





[www.jbmcamp.com](http://www.jbmcamp.com)

 /JBMprofessionaltools

 @jbmtools

 jbmtools

 JBM Campllong S.L.U